

Assessment of Ion Exchange, Adsorptive Media and RCF for Cr(VI) Removal



About the Water Research Foundation

The Water Research Foundation (WRF) is a member-supported, international, 501(c)(3) nonprofit organization that sponsors research that enables water utilities, public health agencies, and other professionals to provide safe and affordable drinking water to consumers.

WRF's mission is to advance the science of water to improve the quality of life. To achieve this mission, WRF sponsors studies on all aspects of drinking water, including resources, treatment, and distribution. Nearly 1,000 water utilities, consulting firms, and manufacturers in North America and abroad contribute subscription payments to support WRF's work. Additional funding comes from collaborative partnerships with other national and international organizations and the U.S. federal government, allowing for resources to be leveraged, expertise to be shared, and broad-based knowledge to be developed and disseminated.

From its headquarters in Denver, Colorado, WRF's staff directs and supports the efforts of more than 800 volunteers who serve on the board of trustees and various committees. These volunteers represent many facets of the water industry, and contribute their expertise to select and monitor research studies that benefit the entire drinking water community.

Research results are disseminated through a number of channels, including reports, the Website, Webcasts, workshops, and periodicals.

WRF serves as a cooperative program providing subscribers the opportunity to pool their resources and build upon each other's expertise. By applying WRF research findings, subscribers can save substantial costs and stay on the leading edge of drinking water science and technology. Since its inception, WRF has supplied the water community with more than \$460 million in applied research value.

More information about WRF and how to become a subscriber is available at www.WaterRF.org.

Assessment of Ion Exchange, Adsorptive Media and RCF for Cr(VI) Removal

Prepared by:
Nicole Blute*, PhD, PE
Hazen and Sawyer

Xueying (Ying) Wu*, DEnv, PE
Hazen and Sawyer

Greg Imamura, Yanguang Song, PhD, PE and Katie Porter, PE
ARCADIS U.S., Inc.

Charles Cron
CDM Smith

Leighton Fong, PE, Donald Froelich, PE, and Ramon Abueg, PE
City of Glendale, California

Tarrah Henrie, Shreya Ramesh, Frank Vallejo
California Water Service Company

*Part of the research conducted as employees of ARCADIS U.S., Inc.

Jointly sponsored by:
Water Research Foundation
6666 West Quincy Avenue, Denver, CO 80235

and

California Division of Drinking Water and Department of Water Resources Proposition 50

Published by:
Water Research Foundation



DISCLAIMER

This study was funded by the Water Research Foundation (WRF). WRF assumes no responsibility for the content of the research study reported in this publication or for the opinions or statements of fact expressed in the report. The mention of trade names for commercial products does not represent or imply the approval or endorsement of WRF. This report is presented solely for informational purposes.

Copyright © 2015
by Water Research Foundation

ALL RIGHTS RESERVED.
No part of this publication may be copied, reproduced
or otherwise utilized without permission.

ISBN xxx-x-xxxxx-xxx-x

Printed in the U.S.A.

CONTENTS

TABLES	ix
FIGURES	xiii
FOREWORD	xvii
ACKNOWLEDGMENTS	xix
EXECUTIVE SUMMARY	xxi
CHAPTER 1: INTRODUCTION.....	1
Identification of Research Needs	1
Project Scope	2
Objectives	2
CHAPTER 2: WEAK BASE ANION EXCHANGE	3
Experimental Methodology	3
WBA Resins.....	3
Test Water Quality	3
Pilot Unit.....	5
Operational Conditions	7
Sampling and Monitoring	8
Analytical Methods.....	9
Additional Pilot Testing to Assess Early Cr(VI) Breakthrough	11
Results.....	12
Chromium Removal by Purolite S106 and ResinTech SIR-700	12
Chromium Removal by Dow PWA7 at Livermore using Hydrochloric Acid for pH Adjustment.....	18
Simultaneous Removal of Other Constituents.....	19
Constituents Leaching.....	20
Residuals Characteristics	21
Dow PWA7 Preconditioning Study and Operational Shutdown Testing of Constituent Leaching.....	22
Summary and Conclusions	24
CHAPTER 3: SINGLE-PASS STRONG BASE ANION EXCHANGE.....	25
Experimental Methodology	25
SBA Resins	25
Test Water Quality	25
Pilot Unit.....	26
Operational Conditions	27
Sampling and Monitoring	27
Analytical Methods.....	28
Results.....	29

Chromium Removal.....	29
Simultaneous Removal of Other Constituents.....	32
Constituent Leaching.....	35
Residuals Characteristics.....	37
Summary and Conclusions.....	39
CHAPTER 4: REDUCTION, COAGULATION AND FILTRATION.....	41
Experimental Methodology.....	41
Test Water Quality.....	41
RCF Process.....	42
Operational Conditions.....	43
Sampling and Monitoring.....	44
Analytical Methods.....	44
Results.....	45
Summary and Conclusions.....	51
CHAPTER 5: ADSORPTIVE MEDIA.....	53
Experimental Methodology.....	53
Test Water Quality.....	53
Pilot System.....	55
Operational Conditions.....	56
Sampling and Monitoring.....	57
Analytical Methods.....	58
Results.....	59
Chromium Removal.....	59
Acid Regeneration.....	64
Simultaneous Removal of Other Constituents.....	64
Constituents Leaching.....	65
Residuals Characteristics.....	66
Summary and Conclusions.....	67
CHAPTER 6: COST ESTIMATES.....	69
Methodology.....	69
Design Water Quality.....	71
WBA.....	72
Capital Cost.....	73
O&M Cost.....	74
Unit Treatment Cost.....	77
RCF.....	77
Capital Cost.....	79
O&M Cost.....	81
Unit Treatment Cost.....	82
REFERENCES.....	83
ABBREVIATIONS.....	85

APPENDIX A: DOW PWA7 PRECONDITIONING STUDY	89
APPENDIX B: DETAILED COST SHEETS	108

TABLES

2.1	Properties of the WBA resins	3
2.2	Raw water quality in Well GS-3 at Glendale.....	4
2.3	Raw water quality at Livermore – Well 12.....	5
2.4	WBA pilot operational conditions	8
2.5	WBA pilot sampling and analysis frequency.....	9
2.6	Analytical methods	11
2.7	Constituents removed by Purolite S106 and ResinTech SIR-700	20
2.8	Spent WBA resins characteristics at the Glendale site	22
3.1	Properties of the SBA resins	25
3.2	Raw water quality at Glendale and Livermore	26
3.3	SBA operational conditions	27
3.4	SBA pilot sampling and analysis frequency	28
3.5	Constituents removed by SBA resins at Glendale	33
3.6	Constituents removed by SBA resins at Livermore.....	34
3.7	Summary of Constituents removed by SBA resins at Glendale and Livermore.....	35
3.8	Constituents detected in treated water from SBA resins at Glendale	36
3.9	Constituents detected in treated water from SBA resins at Livermore.....	36
3.10	Spent SBA resin characteristics at the Glendale site	38
4.1	RCF test water quality	41
4.2	RCF operational conditions	43
4.3	RCF sampling and analysis frequency.....	44
4.4	Analytical methods	45

4.5	RCF ferrous and chlorine dose	48
4.6	RCF turbidity and total iron in filter effluent.....	50
5.1	Test water quality.....	54
5.2	Cleanit® operational conditions and test runs	57
5.3	Cleanit® adsorptive media sampling and analysis frequency	58
5.4	Cleanit® adsorptive media effluent water quality	65
5.5	Cleanit® constituents leaching at initial flush*	66
5.6	Cleanit® backwash wastewater characteristics	66
5.7	Cleanit® spent media characteristics.....	67
6.1	Capital cost factors assumptions.....	70
6.2	Engineering factors assumptions	71
6.3	Design raw water quality for WBA and RCF	71
6.4	WBA design criteria	73
6.5	WBA capital costs	74
6.6	WBA resin costs and operational life	76
6.7	WBA annual O&M Cost.....	76
6.8	WBA 20-year NPV of O&M cost.....	77
6.9	WBA unit treatment cost (\$/AF)	77
6.10	RCF design criteria	79
6.11	RCF capital cost	80
6.12	RCF annual O&M cost	82
6.13	RCF 20-year NPV of O&M cost	82
6.14	RCF unit treatment cost (\$/AF)	82

A.1	Resin holding test after pre-conditioning at Evoqua Facility	93
A.2	Formaldehyde in resin effluent during and after pre-conditioning at the Evoqua Facility using the Dow 2013 preconditioning procedure.....	96
A.3	Resin holding test results after pre-conditioning at the Evoqua Facility using the Dow 2013 preconditioning procedure	97
A.4	Formaldehyde results during resin installation at Glendale using the Dow 2013 preconditioning procedure	99
A.5	Formaldehyde in resin effluent after pre-conditioning using the Dow 2014 preconditioning procedure	105
A.6	Formaldehyde in resin effluent after pre-conditioning at Glendale using the 2014 preconditioning procedure	106
B.1	Estimated AACE Class 5 capital costs for 100-gpm WBA system with Dow PWA7....	111
B.2	Estimated AACE Class 5 capital costs for 500-gpm WBA system with Dow PWA7....	112
B.3	Estimated AACE Class 5 capital costs for 2000-gpm WBA system with Dow PWA7..	113
B.4	Estimated AACE Class 5 O&M costs for WBA systems with Dow PWA7	114
B.5	Estimated AACE Class 5 capital costs for 100-gpm WBA system with ResinTech SIR-700.....	115
B.6	Estimated AACE Class 5 capital costs for 500-gpm WBA system with ResinTech SIR-700.....	116
B.7	Estimated AACE Class 5 capital costs for 2000-gpm WBA system with ResinTech SIR-700.....	117
B.8	Estimated AACE Class 5 O&M costs for WBA systems with ResinTech SIR-700.....	118
B.9	Estimated AACE Class 5 capital costs for 100-gpm WBA system with Purolite S106... ..	119
B.10	Estimated AACE Class 5 capital costs for 500-gpm WBA system with Purolite S106... ..	120
B.11	Estimated AACE Class 5 capital costs for 2000-gpm WBA system with Purolite S106.	121

B.12	Estimated AACE Class 5 O&M costs for WBA systems with Purolite S106 (150,000 BVs)	122
B.13	Estimated AACE Class 5 O&M costs for WBA systems with Purolite S106 (260,000 BVs)	122
B.14	Estimated AACE Class 5 capital costs for 100-gpm RCF system with recycle	123
B.15	Estimated AACE Class 5 capital costs for 500-gpm RCF system with recycle	125
B.16	Estimated AACE Class 5 capital costs for 2000-gpm RCF system with recycle	127
B.17	Estimated AACE Class 5 O&M costs for RCF systems with recycle	129
B.18	Estimated AACE Class 5 capital costs for 100-gpm RCF system without recycle	130
B.19	Estimated AACE Class 5 capital costs for 500-gpm RCF system without recycle	132
B.20	Estimated AACE Class 5 capital costs for 2000-gpm RCF system without recycle	134
B.21	Estimated AACE Class 5 O&M costs for RCF systems without recycle	136

FIGURES

2.1	Schematic of pilot testing skid for ion exchange	6
2.2	Photograph of an example ion exchange pilot unit.....	7
2.3	Cr(VI) breakthrough for Purolite S106 and ResinTech SIR-700 at Glendale	13
2.4	Total Cr breakthrough for Purolite S106 and ResinTech SIR-700 at Glendale	13
2.5	Confirmation of Cr(VI) initial leakage for Purolite S106 at Glendale	14
2.6	Confirmation of Total Cr initial leakage for Purolite S106 at Glendale.....	15
2.7	Confirmation of Cr(VI) initial leakage for ResinTech SIR-700 at Glendale.....	15
2.8	Confirmation of Total Cr initial leakage for ResinTech SIR-700 at Glendale.....	16
2.9	Cr(VI) breakthrough for ResinTech SIR-700 in lead-lag configuration	17
2.10	Total Cr breakthrough for ResinTech SIR-700 in lead-lag configuration.....	17
2.11	Cr(VI) breakthrough for Dow PWA7 at Livermore using hydrochloric acid for pH adjustment.....	18
2.12	Total Cr breakthrough for Dow PWA7 at Livermore using hydrochloric acid for pH adjustment.....	19
3.1	Cr(VI) breakthrough for SBA Resins at Glendale	30
3.2	Total Cr breakthrough for SBA Resins at Glendale	30
3.3	Cr(VI) breakthrough for SBA Resins at Livermore	31
3.4	Total Cr breakthrough for SBA Resins at Livermore.....	31
4.1	Schematic of RCF process evaluated in this study	42
4.2	RCF post-reduction Cr(VI) with various reduction times and chlorination	46
4.3	RCF filter effluent Cr(VI) with various reduction times and chlorination	47
4.4	RCF ferrous iron oxidation by chlorination or aeration.....	49
4.5	RCF filter effluent Total Cr with various reduction times and chlorination.....	50

5.1	Schematic of Cleanit® Pilot Unit	55
5.2	Photograph of Cleanit® Pilot Unit	56
5.3	Cleanit® Cr(VI) breakthrough in Run 1 (30 and 15-min EBCT).....	59
5.4	Cleanit® Total Cr breakthrough in Run 1 (30 and 15-min EBCT)	60
5.5	Cleanit® Cr(VI) breakthrough in Run 2 (15-min EBCT)	61
5.6	Cleanit® Total Cr breakthrough in Run 2 (15-min EBCT).....	61
5.7	Cleanit® Cr(VI) breakthrough in Run 3 (15-min EBCT)	62
5.8	Cleanit® Total Cr breakthrough in Run 3 (15-min EBCT)	63
6.1	Approach for Developing WBA and RCF Estimates	70
6.2	WBA Process Flow Diagram.....	76
6.3	RCF Process Flow Diagram.....	78
A.1	Resin preconditioning vessel	92
A.2	Photograph of small columns used for resin holding test	93
A.3	Formaldehyde leaching from preconditioned resins using the Dow 2013 preconditioning procedure under (a) saturated conditions and (b) dewatered conditions at varying holding times	98
A.4	Formaldehyde leaching from preconditioned resins at Glendale using the Dow 2013 preconditioning procedure after installation	100
A.5	Formaldehyde leaching from preconditioned resin using the Dow 2013 preconditioning procedure when exposed to raw groundwater at pH 7.2 vs pH 6.0	101
A.6	Formaldehyde leaching after 72-hour shutdown	102
A.7	Nitrate leaching after 72-hour shutdown	102
A.8	Hexavalent chromium leaching after 72-hour shutdown.....	103
A.9	Total chromium leaching after 72-hour shutdown.....	103
A.10	Hexavalent chromium leaching after 4-hour shutdown.....	104

A.11	Total chromium leaching after 4-hour shutdown.....	104
A.12	Formaldehyde leaching from preconditioned resin at Glendale using the 2014 preconditioning procedure	106

FOREWORD

The Water Research Foundation (WRF) is a nonprofit corporation dedicated to the development and implementation of scientifically sound research designed to help drinking water utilities respond to regulatory requirements and address high-priority concerns. WRF's research agenda is developed through a process of consultation with WRF subscribers and other drinking water professionals. WRF's Board of Trustees and other professional volunteers help prioritize and select research projects for funding based upon current and future industry needs, applicability, and past work. WRF sponsors research projects through the Focus Area, Emerging Opportunities, and Tailored Collaboration programs, as well as various joint research efforts with organizations such as the U.S. Environmental Protection Agency and the U.S. Bureau of Reclamation.

This publication is a result of a research project fully funded or funded in part by WRF subscribers. WRF's subscription program provides a cost-effective and collaborative method for funding research in the public interest. The research investment that underpins this report will intrinsically increase in value as the findings are applied in communities throughout the world. WRF research projects are managed closely from their inception to the final report by the staff and a large cadre of volunteers who willingly contribute their time and expertise. WRF provides planning, management, and technical oversight and awards contracts to other institutions such as water utilities, universities, and engineering firms to conduct the research.

A broad spectrum of water supply issues is addressed by WRF's research agenda, including resources, treatment and operations, distribution and storage, water quality and analysis, toxicology, economics, and management. The ultimate purpose of the coordinated effort is to assist water suppliers to provide a reliable supply of safe and affordable drinking water to consumers. The true benefits of WRF's research are realized when the results are implemented at the utility level. WRF's staff and Board of Trustees are pleased to offer this publication as a contribution toward that end.

Denise L. Kruger
Chair, Board of Trustees
Water Research Foundation

Robert C. Renner, P.E.
Executive Director
Water Research Foundation

ACKNOWLEDGMENTS

The authors thank the Project Advisory Committee (PAC) – including Mr. Eugene Leung, California Division of Drinking Water (DDW), Dr. Sun Liang, Water Purification Unit Manager of the Water Quality Section of the Metropolitan Water District of Southern California, Los Angeles, Calif.; Dr. Richard Sakaji, Manager of Planning and Analysis for Water Quality of the East Bay Municipal Utility District, Oakland, Calif. (formerly with the California Department of Health Services in Richmond, Calif.); Dr. Bruce Macler, Project Officer, U.S. Environmental Protection Agency, and Dr. Pankaj Parekh, past Director of Water Quality of the Los Angeles Department of Water and Power, Los Angeles, Calif.. We also thank WRF project manager Alice Fulmer for her assistance throughout the project. Additional staff who contributed to this work include Devon Cotton and Dan Hutton (CDM Smith), Kenny Chau, Ian Mackenzie and David Rodriguez (Hazen and Sawyer), Stephanie Tong (ARCADIS), Robert Brewer (California Water Service Company), and Bill Patterson (California Water Service Company). The authors are grateful for the startup and troubleshooting service provided by Thomas Lavis and Kyle Unger (North American Höganäs) for the adsorptive media pilot system.

The work was co-funded and administered by DDW and the California Department of Water Resources (DWR) through Proposition 50 funding. The adsorptive media Cleanit® pilot system and startup/trouble shooting service were provided by North American Höganäs as in-kind services. Dow PWA7 preconditioning testing of resin was funded by Dow and Siemens Water Technologies (now Evoqua Water Technologies LLC) in the form of in-kind services and by DDW and DWR Proposition 50 funding.

EXECUTIVE SUMMARY

OBJECTIVES

The objectives of this study were to build upon existing research to test simple and cost-effective treatment options for removal of hexavalent chromium, Cr(VI). Specifically, this study:

- Determined the effectiveness of potential single-pass technologies (weak base anion exchange or WBA, strong base anion exchange or SBA, and adsorptive media) for removal of Cr(VI) and co-occurring contaminants in two different water qualities,
- Determined the effectiveness of the reduction coagulation filtration (RCF) process with decreased reduction times and chlorination in place of aeration,
- Assessed the operational requirements of the treatment options, and
- Identified costs of treatment for the new approaches if effective.

BACKGROUND

A new Cr(VI) maximum contaminant level (MCL) of 10 µg/L was released in California in July 2014. Many drinking water utilities require solutions for effectively removing Cr(VI) from their supplies to comply with the regulatory limit. On a federal level, the USEPA is considering a separate regulation for Cr(VI) or a change to the existing Total Cr MCL.

A significant amount of research and demonstration testing has been conducted on Cr(VI) treatment approaches, leading to the establishment of the best available technologies (listed in the California MCL), including ion exchange, RCF, and reverse osmosis. An outcome of the previous work was the identification of a need for testing streamlined approaches and alternate media (ion exchange and adsorptive) to minimize waste disposal issues and facility size. The broader applicability of the technologies for different water qualities also needed to be evaluated.

Of the best available technologies, two types of anion exchange are effective for Cr(VI) removal –WBA and SBA. WBA offers relatively simple, once-through treatment with a very high Cr(VI) capacity. However, the one proven WBA resin at the time of this project start had initial formaldehyde leaching after startup due to the resin matrix. Two other WBA resins later became certified to meet NSF/ANSI 61 standard for use in drinking water treatment and are made of a different material that is not likely to leach formaldehyde. One of these resins has been tested briefly at pilot-scale in Glendale with mixed results that required additional study.

SBA can be applied either as single-pass media or with periodic regeneration using salt brine solution. Regenerable SBA applicability is limited by the availability of brine disposal in many locations and may require trucking the brine waste offsite. A single-pass mode of operation (i.e., without brine regeneration) can be attractive for wellhead treatment systems where space is a premium and a low degree of complexity is necessary. The applicability of the single-pass approach is dictated by other constituents in the water that limit Cr(VI) capacity (primarily sulfate). In general, SBA offers much lower throughput before replacement is needed compared to WBA resin (one to two orders of magnitude), but does not require pH adjustment.

RCF treatment has been proven to be effective but requires significant footprint and may be difficult to fit at many well sites. Bench-scale testing in other projects suggested that reduction time in the RCF process may be decreased from 45 minutes to approximately 5 minutes if the iron

dose is increased and oxidation of residual ferrous is accomplished with chlorination rather than aeration, which would decrease both the facility size and cost. This alternative approach had not been tested at demonstration scale until this project.

Although not a best available technology, adsorptive media (called adsorptive media in this report) showed promise in previous bench testing for Cr(VI) removal. One iron-based adsorptive media (sulfur modified iron) had a higher capacity than SBA resins and other adsorptive media in bench testing but was not ready for pilot scale at the time of that work due to operational challenges. The media had reportedly evolved, and a similar media comprised of permeable iron composite material was also identified that had been successfully applied in an industrial Cr(VI) removal application. These iron-based adsorptive media were therefore included in this project to evaluate Cr(VI) treatment performance and treatment process requirements.

APPROACH

The initial concept for this project focused on testing of single-pass media for Cr(VI) removal, including two new WBA resins and three SBA resins with two different water qualities (Livermore and Glendale, California). In addition, one adsorptive media was planned to be tested at Livermore and one at Glendale. As the research proceeded, several major challenges with the well were encountered at Livermore resulting in a delay of the WBA and adsorptive media testing. At the same time, new information became available from other research on the minor impact of water quality on WBA resin performance and the potential for modifications to the RCF system that could offer a smaller footprint. Therefore, the research scope was modified to include evaluation of RCF in place of extensive WBA and adsorptive media testing at Livermore. The revised approach included the following components:

- Pilot-scale testing of two WBA resins for comparison with the WBA resin being used in demonstration-scale testing at Glendale,
- Evaluation of resin preconditioning procedure effectiveness to minimize formaldehyde leaching from WBA resin,
- Pilot-scale testing of three SBA resins in single-pass mode at Livermore and Glendale,
- Demonstration-scale testing of RCF with decreased reduction times and chlorination replacing aeration, and
- Pilot testing of one iron-based adsorptive media.

RESULTS/CONCLUSIONS

Results of this project identify additional options for Cr(VI) removal from drinking water, and provide an improved understanding of technology applicability in other water qualities.

This study confirmed that the WBA resin used in Glendale demonstration-testing (Dow PWA7) is also effective in Livermore water, with a greater capacity likely due to lower Cr(VI) concentrations. Preconditioning of this resin with the cross-regeneration method developed by the manufacturer was effective at decreasing formaldehyde concentrations at the pretreatment facility, but leaching still occurred when the resin encountered the lower pH water necessary for Cr(VI) removal. Additional development and testing was later conducted with a new preconditioning

procedure, resulting in a method to decrease formaldehyde below the Notification Level of 100 µg/L in California.

WBA testing also showed that the two new resins (Purolite S106 and ResinTech SIR700) tested have a high overall capacity for Cr(VI). This is consistent with pilot testing results of the previously tested WBA resin (i.e., greater than 9 months of operation before breakthrough). Both of the new resins differed from the other resin Dow PWA7 in that they exhibited initial leakage of low levels of Cr(VI). It was hypothesized that this impact was observed due to relatively elevated sulfate concentrations, since leakage was observed in another study with high sulfate (Chowdhury et al., 2014) and not in another with low sulfate (Najm et al., 2014). Testing demonstrated that this impact can potentially be minimized with a lead-lag configuration. These two resins offer the advantage of not leaching constituents of concern above regulatory limits. Similar to Dow PWA7, these resins accumulate uranium and will have specific disposal requirements.

SBA resins tested at Glendale and Livermore showed a relatively short resin life of less than 5 days for all three resins (Purolite A600E/9149, Dow SAR, and Envirogen HyperSorb A3-2-1), with longer performance for Livermore's water (approximately 10 days) to reach the influent concentration of 9-10 ppb. Sulfate is known to impact Cr(VI) removal by SBA resins, which is consistent with this testing in which Livermore has half the sulfate level as Glendale. Simultaneous removal of other constituents, including nitrate, sulfate, and phosphate were observed by all three resins but with faster breakthrough than Cr(VI). Uranium was removed with a greater selectivity than Cr(VI) resulting in longer time to breakthrough. The results highlighted the importance of testing new resins before installation, as two resins lasted between three to five times longer than the other resin.

Results from this project indicate that the RCF process can be optimized by decreasing reduction time and substituting chlorination for aeration to oxidize remaining iron. Cr(VI) was effectively reduced in 5 minutes with the higher iron dose. The initial reason why aeration was used to oxidize the remaining iron, concern that chlorine could oxidize Cr(III) to Cr(VI), was in fact observed in the testing. The magnitude of the reoxidation varied, with some samples showing minimal reoxidation and others showing significant reoxidation. The results indicate that tight controls are necessary if chlorine is used for oxidation of ferrous iron to minimize oxidation of Cr(III) to Cr(VI). The findings also showed that effective filter backwash is critical for Total Cr removal, as poor Total Cr removal was occasionally observed when filter backwash was insufficient to clean the bed due to challenges with wastewater disposal at the site.

Iron-based adsorptive media tested at Glendale showed that it removed Cr(VI) and Total Cr, with breakthrough occurring at a throughput similar to SBA resin. A much longer contact time is necessary for the adsorptive media (minimum of 15 minutes) compared with SBA (minimum of 2 minutes), and iron treatment downstream is necessary due to high levels leaching from the media into the water. Testing also showed that while pH adjustment was not necessary, the media experienced calcium carbonate precipitation, which was overcome by adding polyphosphate to the raw water. Overall, the adsorptive media will have a larger footprint, which makes it less attractive than SBA unless removal of co-occurring constituents like nitrate are desired and brine disposal is difficult. Additional pilot testing would be necessary to understand long term performance of the media and identify ways to overcome formation of other potentially problematic by-products. This testing worked through operational challenges with the new adsorptive media and provided high level proof-of-concept testing.

APPLICATIONS/RECOMMENDATIONS

This research provides treatment solutions to water agencies needing Cr(VI) treatment. In particular, two new WBA resins (Purolite S106 and ResinTech SIR700) were demonstrated to be effective alternatives to the one previously tested (Dow PWA7), without formaldehyde leaching. The manufacturer of the previously tested resin developed a method to decrease formaldehyde leaching from that resin, and tests showed that new procedures can minimize this effect. SBA resins offer another treatment option, possibly in a single-pass mode of operation if sulfate levels are low. Iron-based adsorptive media continues to hold promise in Cr(VI) removal as shown by this testing, but additional study is needed on regeneration and iron removal prior to implementation (and obtaining conditional approval by the California Division of Drinking Water, DDW, as an alternate technology). As in prior studies, this testing demonstrated the importance of pilot testing new media, as reported performance was not always achieved in practice.

Water agencies can directly use the findings from the WBA and SBA testing at this point. The RCF process requires additional studies if an agency wishes to decrease the reduction time below 30 minutes or use chlorination in place of aeration, since the controls necessary to prevent reoxidation of Cr(III) are not fully understood. However, the optimized RCF process would be significantly smaller in size and cost, which would make this technology even more attractive. An additional study is underway at Glendale to further investigate the RCF process.

RESEARCH PARTNERS

This project was co-sponsored by the California Water Service Company and the City of Glendale, California. Matching funds were provided by DDW and DWR through Proposition 50 funding. The adsorptive media Cleanit® pilot system and startup/trouble shooting service were provided by North American Höganäs as in-kind services. Dow PWA7 preconditioning testing of resin was funded by Dow and Siemens Water Technologies (now Evoqua Water Technologies LLC) in the form of in-kind services and by DDW and DWR Proposition 50 funding.

PARTICIPANTS

Project guidance was provided by the Project Advisory Committee (PAC) – including Mr. Eugene Leung, DDW; Dr. Sun Liang, Water Purification Unit Manager of the Water Quality Section of the Metropolitan Water District of Southern California, Los Angeles, Calif.; Dr. Richard Sakaji, Manager of Planning and Analysis for Water Quality of the East Bay Municipal Utility District, Oakland, Calif. (formerly with the California Department of Health Services in Richmond, Calif.); Dr. Bruce Macler, Project Officer, U.S. Environmental Protection Agency, and Dr. Pankaj Parekh, past Director of Water Quality of the Los Angeles Department of Water and Power, Los Angeles, Calif..

CHAPTER 1: INTRODUCTION

Hexavalent chromium, Cr(VI), is a naturally occurring element, which can also be released into the environment from industrial processes. Toxicology studies conducted by the National Toxicology Program (NTP) concluded that Cr(VI) is carcinogenic in mice and rats by ingestion (NTP, 2008). The NTP study forms the primary basis for the development of the Cr(VI) Public Health Goal (PHG) of 0.020 parts per billion (ppb) in California. A new Maximum Contaminant Level (MCL) of 10 µg/L for Cr(VI) in drinking water was released by the California Division of Drinking Water (DDW) and became effective in July 2014. The regulatory actions and the need for improvements in treatment options were the principal motivations for this research.

IDENTIFICATION OF RESEARCH NEEDS

The City of Glendale has been managing a major research effort to identify technologies for removing Cr(VI) from drinking water supplies for more than a decade. The research program is divided into several phases – bench testing, pilot testing, and demonstration studies. The Hexavalent Chromium Removal Project Report dated February 28, 2013 summarizes the research findings through each of these phases. The research identified three leading technologies, including weak base anion exchange (WBA), reduction/coagulation/filtration (RCF), and strong base anion exchange (SBA).

Of the three technologies, WBA offers relatively simple, once-through treatment. However, the one proven WBA resin (Dow PWA7) has been problematic due to formaldehyde leaching (an identified human carcinogen) in demonstration testing. Although a resin preconditioning procedure was instituted to treat the WBA resin being tested at Glendale, the procedure was not fully effective at reducing levels to below the California Notification Level of 100 µg/L for formaldehyde. Two other WBA resins (Purolite S106 and ResinTech SIR-700) are epoxy polyamine structures that lack formaldehyde but were identified as having the potential to have a high Cr(VI) capacity based on results from industrial trials.

Regenerable SBA application is limited by the availability of brine disposal. Alternatively, SBA can also be operated in single-pass mode without brine regeneration. In this way, SBA would treat a lower number of bed volumes treated compared with WBA but not require pH adjustment, which could make single-pass SBA attractive for wellhead treatment systems where space is a premium and a low degree of complexity is necessary.

RCF treatment as tested in the Phase III Demonstration Study requires a large footprint and may be difficult to fit at many wellheads. Subsequent bench testing at Glendale, Coachella Valley Water District, and others (WRF #4365, WRF #4450, WRF #4445) suggests that reduction time in the RCF process may be decreased from 45 minutes if the iron dose is increased and oxidation of residual ferrous is accomplished with chlorine rather than aeration; both actions would also decrease the footprint. The potential advantages of an RCF process with 5 to 15 minutes of reduction time, chlorination (rather than aeration that might require off-gas treatment such as at Glendale) and filtration are a significantly smaller footprint for the facilities, less complex operations, and smaller capital expenditures.

Adsorptive/chemical reductive media (referred to in this report as adsorptive media) is an alternative technology for Cr(VI) removal, which has not been intensively tested. One adsorptive media (sulfur modified iron, or SMI) showed promise in Glendale's early Phase I Bench-Scale Testing but was not ready for implementation due to operational issues. The media has reportedly

evolved and is being tested for nitrate removal elsewhere. Another media (North American Höganäs Cleanit®) is a similar adsorptive media using a permeable iron composite material, which was identified for testing in this project.

PROJECT SCOPE

The initial scope of this project focused on testing of single-pass media for Cr(VI) removal, including two new WBA resins and three SBA resins with two different water qualities (Glendale and Livermore, California). In addition, adsorptive media Cleanit® was planned to be tested at Glendale, and SMI was planned to be tested at Livermore. As the research proceeded, several major challenges with the Livermore well were encountered, which delayed the WBA and SMI testing. At the same time, new information became available from other research on the minor impact of water quality on WBA resin performance, and the potential for modifications to the RCF system that could offer a smaller footprint. Therefore, the research scope was modified to include evaluation of RCF in place of WBA and SMI testing at Livermore. The revised scope included the following:

- Pilot-scale testing of two WBA resins, including Purolite S106 and ResinTech SIR-700 (performed at Glendale),
- Evaluation of Dow PWA7 resin preconditioning to minimize formaldehyde leaching (performed at Glendale),
- Pilot-scale testing of three SBA resins, including Dow SAR, Purolite A600E/9149 and Envirogen HyperSorb A3-2-1 (performed at Glendale and Livermore),
- Demonstration-scale testing of RCF with decreased reduction times and chlorination replacing aeration (performed at Glendale), and
- Pilot testing of adsorptive media North American Höganäs Cleanit® adsorptive media (performed at Glendale).

The research was conducted from 2012 to early 2014.

OBJECTIVES

The objectives of this study were to build upon existing research to test simple, sustainable, and cost-effective treatment options for removal of Cr(VI). Specifically, this study:

- Determined the effectiveness of potential single-pass technologies for removal of Cr(VI) and co-occurring contaminants in two different water qualities,
- Determined the effectiveness of RCF with decreased reduction times and chlorination for removal of Cr(VI),
- Determined the effectiveness of adsorptive media for removal of Cr(VI) and co-occurring contaminants,
- Assessed the operational requirements of the treatment options, and
- Identified costs of treatment for these new approaches if effective.

CHAPTER 2: WEAK BASE ANION EXCHANGE

This chapter summarizes the pilot-scale testing of two new WBA resins (Purolite S106 and ResinTech SIR-700) that were tested at Glendale, California. According to the manufacturers, the two resins showed promising Cr(VI) capacity from industrial trials. The pilot testing was designed to evaluate the effectiveness of Cr(VI) removal and co-occurring contaminants using Glendale's groundwater, which allowed a direct comparison to previous performance of Dow PWA7. In addition, PWA7 testing at Livermore, California was also performed. A study of PWA7 preconditioning to minimize formaldehyde leaching was also conducted to evaluate whether this issue could be overcome.

EXPERIMENTAL METHODOLOGY

This section summarizes the experimental methods applied in the pilot testing of Purolite S106 and ResinTech SIR-700 at Glendale and testing of PWA7 at Livermore.

WBA Resins

Table 2.1 compares the properties of Purolite S106 and ResinTech SIR-700 to Dow PWA7. Purolite S106 and ResinTech SIR-700 are reported to be epoxy polyamine resins, which differ from the phenol-formaldehyde (and secondary amine) structure of Dow PWA7 resin. According to the manufacturers, the two resins were not expected to leach formaldehyde like Dow PWA7.

Table 2.1
Properties of the WBA resins

Manufacturer	Resin Name	Matrix	Functional Group
Purolite	S106	Epoxy polyamine	Polyamine
ResinTech	SIR-700	Epoxy polyamine	Proprietary amine
Dow	PWA7	Phenol-formaldehyde polycondensate	Secondary amine

Test Water Quality

At Glendale, Well GS-3 was used for the WBA testing, which was the same water source tested in the previous Cr(VI) research and demonstration-scale operation at Glendale. GS-3 water was pumped from the well, carbon dioxide was added, water passed through bag filters (typically 1 micron), then into the demonstration-scale WBA resin vessels. A side stream of the water with carbon dioxide was used for pilot testing of the two new WBA resins.

Table 2.2 summarizes the test water quality during the period of testing from June 2012 to March 2013, which was sampled before bag filters and carbon dioxide (except pH, temperature and turbidity). The influent Cr(VI) was in the range of 11 – 68 µg/L, with an average of 28 µg/L. Increases in Cr(VI) concentrations were observed starting in March 2013, when Cr(VI) rose from 30 to 68 µg/L. Total Cr levels were similar to Cr(VI). The test water contained moderate chloride (75 mg/L on average), relatively high nitrate (8.2 mg/L as N on average), and moderate to high

sulfate (111 mg/L on average). Alkalinity was relatively high, with an average of 212 mg/L as CaCO₃. Uranium concentrations were in the range of 3.8 – 4.6 µg/L (average 4.3 µg/L) and 2.6 – 3.1 pCi/L (average 2.9 pCi/L). Other parameters monitored include arsenic, phosphate, silica, total organic carbon (TOC), total suspended solids (TSS) and turbidity.

Table 2.2
Raw water quality in Well GS-3 at Glendale

Water Quality Parameter (unit)	Average	Range
Alkalinity (mg/L as CaCO ₃)	212	200 – 220
Arsenic, Total (µg/L)	<1	<1 – 3.3
Chloride (mg/L)	75	72 – 80
Cr(VI) (µg/L)	28	11 – 68
Chromium, Total (µg/L)	27	18 – 63
Nitrate (mg/L as N)	8.2	7.8 – 8.9
pH*	6.17	5.80 – 6.79
Phosphate (mg/L as PO ₄)	0.16	0.10 – 0.18
Silica (mg/L as SiO ₂)	40	35 – 43
Sulfate (mg/L as SO ₄)	111	110 – 120
Temperature (°C)*	20.0	16.8 – 23.6
Total Organic Carbon (TOC) (mg/L)	0.52	0.43 – 0.74
Total Suspended Solids (TSS) (mg/L)	<10	<10
Turbidity (NTU)**	0.26	0.14 – 0.44
Uranium (µg/L)	4.3	3.8 – 4.6
Uranium (pCi/L)	2.9	2.6 – 3.1

*pH and temperature were based on field results for raw water with carbon dioxide from June 2012 to January 2013.

**Turbidity was based on lab results for raw water with carbon dioxide from June to August 2012.

One of the initial objectives was to evaluate performance of the WBA resins (Purolite S106, ResinTech SIR-700 and Dow PWA7) in different water qualities - at Glendale and Livermore, California. At Livermore, three WBA resins were originally installed for testing. Sulfuric acid was selected for pH adjustment for the two new resins because of the potential cost savings compared to hydrochloric acid (HCl). In addition, HCl was used for pH adjustment for Dow PWA7 to provide an apples-to-apples comparison with prior Glendale pilot testing. However, large pH fluctuations were observed with the pilot acid feed and pH control system, which demanded extensive troubleshooting of the sulfuric acid system. Testing showed that the pH fluctuations were due to the steep slope of the titration curve in the pH region of 5.5 to 6.0 with Livermore's highly buffered water. For example, a small change in acid feed (3% sulfuric acid) from 10 mL/min to 15 mL/min decreased pH from 6.1 to 5.5. Dow PWA7 was tested at Livermore with pH 6.0 adjusted by HCl from August to November 2012, to provide a comparison with Glendale. The sulfuric acid feed was unable to provide precise and consistent acid feed to achieve the target pH range; therefore, when the Livermore well went offline for multiple months starting in November 2012,

the scope was revised to focus on WBA testing at Livermore and RCF testing at Glendale. The available results for Dow PWA7 at Livermore are presented in this report.

Table 2.3 summarizes the raw water quality at Livermore for WBA pilot testing. The results are based on raw water before acid addition for the period of August to November 2012 (except pH and temperature for samples after HCl injection). Cr(VI) and Total Cr were in the range of 9.3 – 10.0 and 8.4 – 11.0 µg/L, respectively, which were lower than typical Cr(VI) concentrations at Glendale. Alkalinity was relatively high at Livermore, with an average of 297 mg/L as CaCO₃. The test water contained moderate chloride (97 mg/L on average), high nitrate (10.5 mg/L as N on average) and relatively low sulfate (55 mg/L on average). Uranium concentrations were lower than Glendale’s GS-3 water quality. Other parameters monitored include arsenic, phosphate, silica, TOC and TSS.

Table 2.3
Raw water quality at Livermore – Well 12

Water Quality Parameter (unit)	Average	Range
Alkalinity (mg/L as CaCO ₃)	297	280 – 310
Arsenic (V) (µg/L)	<1	<1
Arsenic, Total (µg/L)	1.0	<1 – 1.2
Chloride (mg/L)	97	92 – 100
Cr(VI) (µg/L)	9.7	9.3 – 10.0
Chromium, Total (µg/L)	9.5	8.4 – 11.0
Nitrate (mg/L as N)	10.5	10 – 11
pH*	5.9	5.7 – 6.2
Phosphate (mg/L as PO ₄)	0.25	0.24 – 0.25
Silica (mg/L as SiO ₂)	35	33 – 41
Sulfate (mg/L as SO ₄)	55	52 – 58
Total Organic Carbon (TOC) (mg/L)	N/A	0.34
Total Suspended Solids (TSS) (mg/L)	N/A	<10
Uranium (µg/L)	1.4	1.3 – 1.5
Uranium (pCi/L)	0.85	<0.7 - 0.93

*pH was based on field results for raw water with hydrochloric acid from August to November 2012. The pH range represents 5th to 95th percentile of the pH readings of the online pH meter.
N/A – not applicable as only one sample was collected due to occasional system shutdowns.

Pilot Unit

Figure 2.1 illustrates the pilot unit and Figure 2.2 shows a photograph. The ion exchange pilot unit consisted of 2.5 inch diameter columns with sampling ports at 50% bed depth and column effluent, as well as a flow meter and totalizer on each column for flow control. A cartridge filter was included for particle removal, but was not used for WBA testing as the test water to the pilot unit had already passed through demonstration-scale bag filters. Another column was used for SBA testing, which is discussed in the next Chapter.

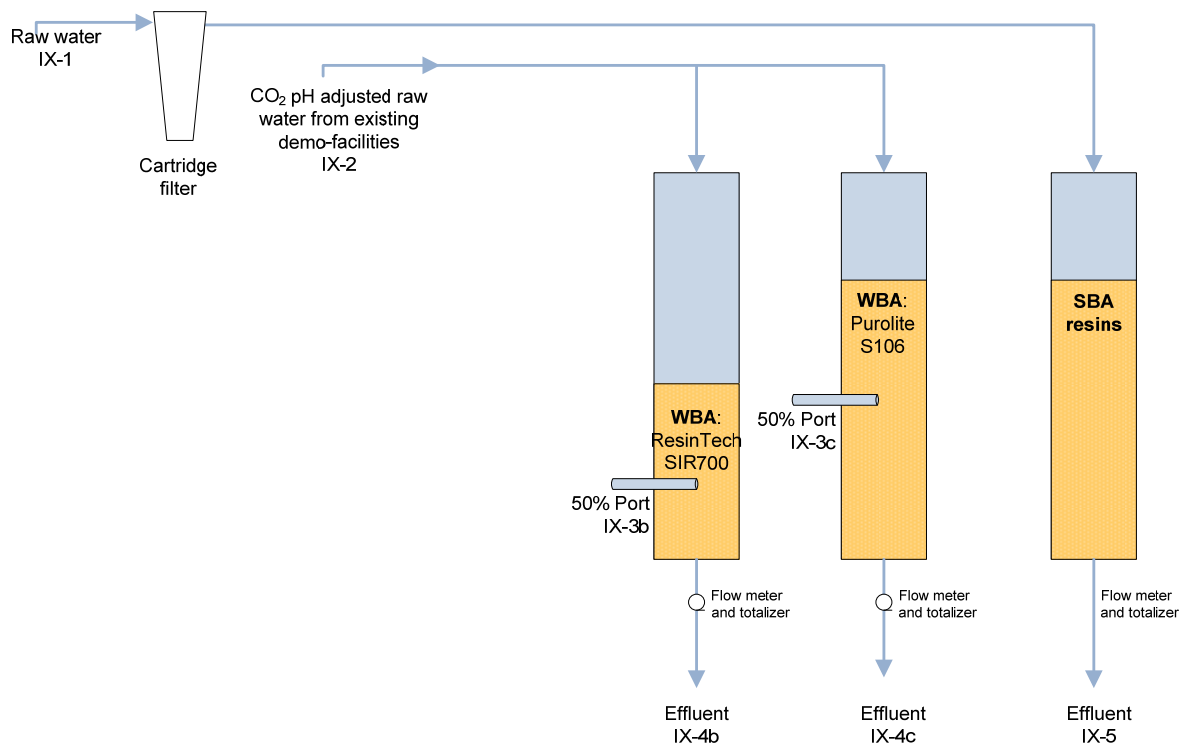

Figure 2.1 Schematic of pilot testing skid for ion exchange

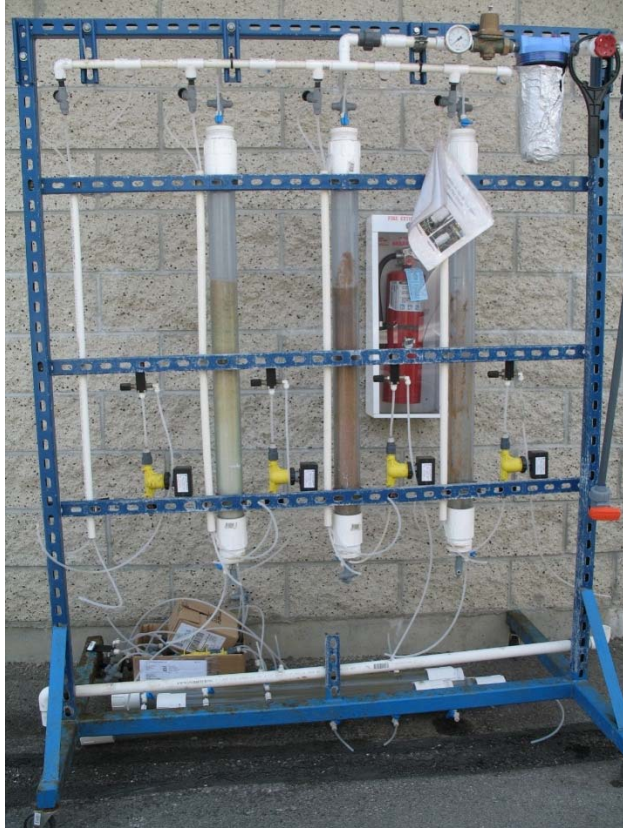

Figure 2.2 Photograph of an example ion exchange pilot unit

Operational Conditions

A column diameter to resin bead diameter ratio of 50 was used although it is lower than the recommended ratio of 100 for filtration studies (Kawamura, 2000; McLellan et al., 2011; Lang et al., 1993). This ratio has been shown to be effective based on previous Glendale pilot testing results that were replicated at the demonstration-scale facility. In addition, Dow states that pilot columns greater than approximately 0.75 inches typically scale up linearly with respect to predicting bed life (Dow 2012).

Table 2.4 shows the operational conditions for WBA resins. A resin bed depth of 13 inches was used for ResinTech SIR-700, which provides an aspect ratio (height to column width) of 5 (exceeding a recommendation of at least 4 according to Dow). The empty bed contact time (EBCT) was 2 minutes. A greater resin bed depth (30 inches) was used for Purolite S106, which provided the minimum EBCT of 3.75 minutes recommended by the resin manufacturer. The hydraulic loading rate (HLR) for ResinTech SIR-700 and Purolite S106 was 4.0 and 5.0 gpm/sf, respectively. The service flow rates were 3.7 and 2.0 gpm/cf, respectively. Due to the greater EBCT for Purolite S106, the number of bed volumes (BVs) per day was less than the number of BVs for ResinTech SIR-700. Both resins were tested for nine months in this study.

The operational pH target was 6.0, which was the pH level tested using Dow PWA7 in previous Cr(VI) research at Glendale. Both ResinTech and Purolite expected the two resins would

be effective for Cr(VI) removal at pH 6.0. Actual operational pH was monitored and is discussed in the results section.

Table 2.4
WBA pilot operational conditions

Design Parameter (unit)	Purolite S106	ResinTech SIR-700
Column Diameter (inch)	2.5	2.5
Cross Sectional Area (sf)	0.034	0.034
Bed Depth (inch)	30	13
Bed Volume (cf)	0.09	0.04
Empty Bed Contact Time (EBCT) (min)	3.75	2.0
Flow Rate (gpm)	0.17	0.14
Hydraulic Loading Rate (HLR) (gpm/sf)	5.0	4.0
Service Flow Rate (gpm/cf)	2.0	3.7
Daily Water Required (gal)	245	196
Bed Volumes per Day per Column	384	720
Operating pH Target	6.0	6.0
Operational Mode	Down flow	Down flow
Run Time	9 months	9 months
Backwash	Not needed during this pilot testing	

Sampling and Monitoring

Table 2.5 summarizes the lab and field sampling and monitoring frequencies during the WBA pilot study. Cr(VI) and Total Cr were monitored weekly for raw water, at 50% of resin bed depth and at resin effluent of each resin column. Cr(VI) and Total Cr samples were collected in pairs to assess chromium speciation. Other parameters were monitored monthly to characterize water quality, including alkalinity, calcium, conductivity, nitrate, phosphate, silicate and sulfate, TOC and TSS. Arsenic was tested to identify if any arsenic removal occurred. pH and temperature were tested weekly in the field. Nitrosamines and formaldehyde, which have been found to leach from PWA7 resin, were measured during startup to see if Purolite S106 and ResinTech SIR-700 would also leach these chemicals. Volatile organic compounds (VOCs), semi-volatile organic compounds (sVOCs) and tentatively identified compounds (TICs) were also monitored at startup to ensure the resins do not introduce a contaminant of concern. Bacteria (Total Coliform, E. Coli and HPC) was monitored initially as well, as this is a requirement for Glendale’s granular activated carbon (GAC) downstream. After 9 months of testing, spent resins were analyzed for uranium to see if the two resins accumulate uranium like Dow PWA7 resin. Spent resins were also characterized using Toxicity Characteristic Leaching Procedure (TCLP) and California Waste Extraction Test (CWET) to assess disposal options. Besides chemical and physical water quality

analyses, process-related parameters were also recorded on a weekly basis, including CO₂ dose, flow rate and numbers of BVs of water treated for each resin column.

Table 2.5
WBA pilot sampling and analysis frequency

Analyte	Lab or Field	Raw Water	Raw Water Post-pH Adjustment	50% Resin Bed Depths	Resin Effluents	Spent Resins
Cr(VI)	Lab	W	W	W	W	N/A
Total Cr	Lab	W	W	W	W	N/A
Alkalinity	Lab	M	N/A	N/A	M	N/A
Arsenic (V)	Lab	M	N/A	N/A	M	N/A
Arsenic, Total	Lab	M	N/A	N/A	M	N/A
Calcium	Lab	M	N/A	N/A	M	N/A
Chloride [^]	Lab	M	N/A	N/A	M	N/A
Conductivity	Lab	M	M	N/A	M	N/A
Nitrate	Lab	M	N/A	N/A	M	N/A
Phosphate	Lab	M	N/A	N/A	M	N/A
Silicate	Lab	M	N/A	N/A	M	N/A
Sulfate	Lab	M	N/A	N/A	M	N/A
TOC	Lab	M	N/A	N/A	N/A	N/A
TSS	Lab	M	N/A	N/A	N/A	N/A
Uranium	Lab	M	N/A	N/A	M	O
pH	Field	W	W	N/A	W	N/A
Temperature	Field	W	W	N/A	W	N/A
Nitrosamines	Lab	S*	N/A	N/A	S*	N/A
SVOCs and TICs	Lab	S	N/A	N/A	S	N/A
VOCs and TICs	Lab	S	N/A	N/A	S	N/A
Aldehydes/Ketones	Lab	S	N/A	N/A	S	N/A
Bacti	Lab	S	N/A	N/A	N/A	N/A
TCLP, CWET	Lab	N/A	N/A	N/A	N/A	O

*Nitrosamines samples were collected at first flush (instantaneous) and after 4 hours of operation.

[^]Chloride was only monitored for the PWA7 column with hydrochloric acid for pH adjustment at Livermore.

W – weekly; M- monthly; N/A – not analyzed; O – Once when spent; S – startup.

At Livermore, the Dow PWA7 pilot was operated with the same conditions for ResinTech SIR-700 as listed in Table 2.4. Water quality sampling and monitoring were similar to Table 2.5, except that Cr(VI) and Total Cr were monitored bi-weekly for raw water post-pH adjustment, 50% resin bed depth and resin effluent.

Analytical Methods

The analytical methods used in the WBA pilot testing are listed in Table 2.6. Total Cr method EPA 200.8 is prone to interference from complexation of carbon and argon, which has the same mass as chromium (52) in the ICP-MS instrument plasma (Eaton 2011, Blute et al. 2013a).

An inter-element correction factor was established for the carbon interference by measuring the carbon isotope in addition to the argon-carbon complex isotope and mathematically correcting each sample result using these factors. The magnitude of the interference is expected to be generally below 1 or 2 $\mu\text{g/L}$. Acid digestion, which is required by the USEPA for Unregulated Contaminant Monitoring Rule 3 (UCMR3) for Total Cr, can be used to minimize the interference by eliminating all of the inorganic carbon and a portion of the organic carbon. In this study, most Total Cr samples were analyzed with digestion, especially when the Total Cr level was expected to be below 5 $\mu\text{g/L}$. A small portion of Total Cr samples were analyzed without digestion, when the Total Cr level was expected to be above 5 $\mu\text{g/L}$.

Table 2.6
Analytical methods

Analyte	Analytical Method	Method Reporting Limit
Cr(VI)	EPA 218.6	0.02 µg/L
Total Cr	EPA 200.8	1 µg/L without acid digestion; 0.2 µg/L with acid digestion
Alkalinity	SM 2320	0.8 mg/L as CaCO ₃
Arsenic (V)	EPA 200.8	1 µg/L
Arsenic, Total	EPA 200.8	1 µg/L
Calcium	EPA 200.7	1 mg/L
Chloride	EPA 300.0A	1 mg/L
Conductivity	SM 2510B	N/A
Nitrate	EPA 300.0	0.1 mg/L as N
Phosphate	SM 4500P-E	0.031 mg/L as PO ₄
Silicate	EPA 200.7	0.2 mg/L as SiO ₂
Sulfate	EPA 300.0A	0.5 mg/L as SO ₄
TOC	SM5310C	0.04 mg/L
TSS	SM 2540D	4.4 mg/L
Uranium (water)	EPA 200.8	0.001 mg/L
pH	SM 4500H+ B	N/A
Temperature	SM 2550	N/A
Nitrosamines	EPA 521	1 ng/L
SVOCs and TICs	EPA 625	Varies by compound
VOCs and TICs	EPA 524.2	Varies by compound
Aldehydes/Ketones	EPA 556	0.005 µg/L
Total Coliform and E. Coli	SM 9223	1.1 MPN/100mL
HPC	SM 9215B	1 CFU/mL
TCLP	EPA 1311	Varies by element
CWET	CWET (Title 22)	Varies by element
Uranium (solid residuals)	ASTM5174-91	0.004 mg/kg

ASTM - American Society of Testing and Materials

EPA - United States Environmental Protection Agency

SM - Standard Methods

N/A - not applicable

Additional Pilot Testing to Assess Early Cr(VI) Breakthrough

During the 9-month WBA pilot testing, early breakthrough of Cr(VI) and Total Cr was observed for both new resins (PuroLite S106 and ResinTech SIR700). The breakthrough occurred in the first two months and then decreased to lower levels (below 3 µg/L or non-detect). It was hypothesized that the early breakthrough could result from pH variations or unidentified constituents in the groundwater that impact initial performance. To answer the question of whether pH variations were the cause of the early breakthrough, additional testing was conducted from August to December 2013, using the same fresh resins (different batches) and operational conditions as in the 9-month pilot. Careful attention was paid to the carbon dioxide dosing and pH

conditions of the water during this testing, with a slightly lower set point (pH 5.9). Water quality sampling and monitoring were conducted as in the 9-month pilot, except that no startup samples (such as nitrosamines, VOCs) were collected.

An additional pilot test was conducted to investigate a solution to mitigate the effects of early breakthrough of Cr(VI) and Total Cr at full scale for the two new resins. This testing used ResinTech SIR-700 in a lead-lag configuration, with the same operational conditions as in the 9-month pilot. Cr(VI) and Total Cr were monitored for raw water, and lead and lag effluents. Field monitoring included pH, temperature, flow rate and BVs.

RESULTS

This section summarizes the pilot results of WBA at Glendale (Purolite S106 and ResinTech SIR-700) and Livermore (Dow PWA7). The results include chromium removal, simultaneous removal of other constituents, unintended consequences and residuals characteristics.

Chromium Removal by Purolite S106 and ResinTech SIR-700

Figure 2.3 shows Cr(VI) breakthrough at the resin effluents for Purolite S106 and ResinTech SIR-700. Influent Cr(VI) concentrations were mostly between 20 and 30 µg/L, except at the end of testing when levels rose. Purolite S106 effluent showed Cr(VI) leakage starting at 2,300 BVs, in which Cr(VI) concentrations reached up to 10 µg/L. However, Cr(VI) levels decreased to 0.025 µg/L or less after approximately 30,000 BVs (approximately two months of operation). Subsequently, Cr(VI) remained non-detect (<0.02 µg/L) until approximately 88,700 BVs and slowly increased to 1.8 µg/L at approximately 105,200 BVs. ResinTech SIR-700 effluent also showed an initial Cr(VI) leakage up to 10 µg/L between 4,400 and 51,900 BVs. Subsequently, Cr(VI) concentrations fluctuated between non-detect and 4 µg/L until levels rose again at approximately 189,000 BVs. The Cr(VI) concentration was 6 µg/L in the end of testing at approximately 200,000 BVs (9 months of operation).

Figure 2.4 shows Total Cr breakthrough at the resin effluents for Purolite S106 and ResinTech SIR-700. Similar to Cr(VI) results, raw water Total Cr levels were relatively stable until the end of the testing. Purolite S106 effluent showed an initial Total Cr breakthrough similar to Cr(VI). Total Cr(VI) also reached up to 10 µg/L during the initial leakage period. The same levels of Cr(VI) and Total Cr concentrations during the initial period suggest Cr(VI) was the dominant chromium species and little Cr(III) was present in the resin effluent. After the initial leakage period, Total Cr decreased to and remained at non-detect levels (< 1 µg/L), except a few data points. Total Cr started to increase again at approximately 86,400 BVs and rose to 4.8 µg/L at 105,000 BVs. ResinTech SIR-700 effluent showed an initial Total Cr breakthrough similar to Cr(VI) between 4,400 and 51,900 BVs. After that, Total Cr levels fluctuated between non-detect and 8 µg/L (most times between 1 and 4 µg/L) and reached 7.7 µg/L at approximately 200,000 BVs.

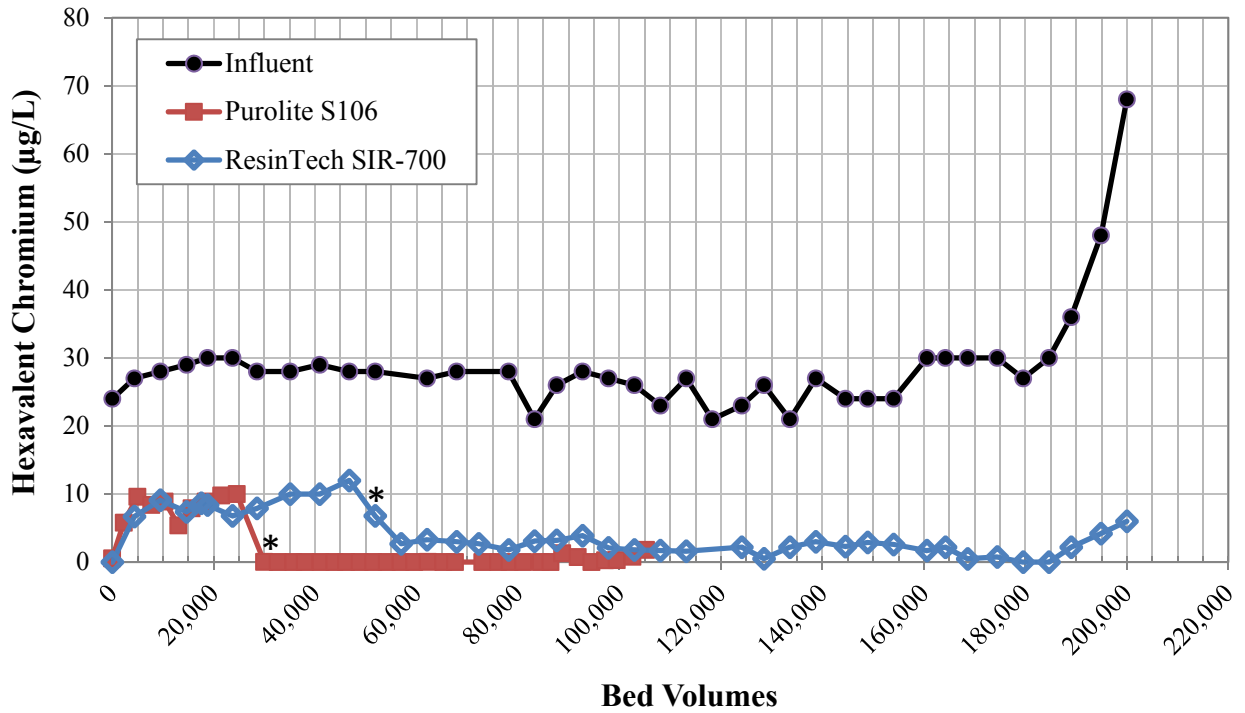

*Influent pH decreased from approximately 6.1 to approximately 5.8-5.9.

Figure 2.3 Cr(VI) breakthrough for Purolite S106 and ResinTech SIR-700 at Glendale

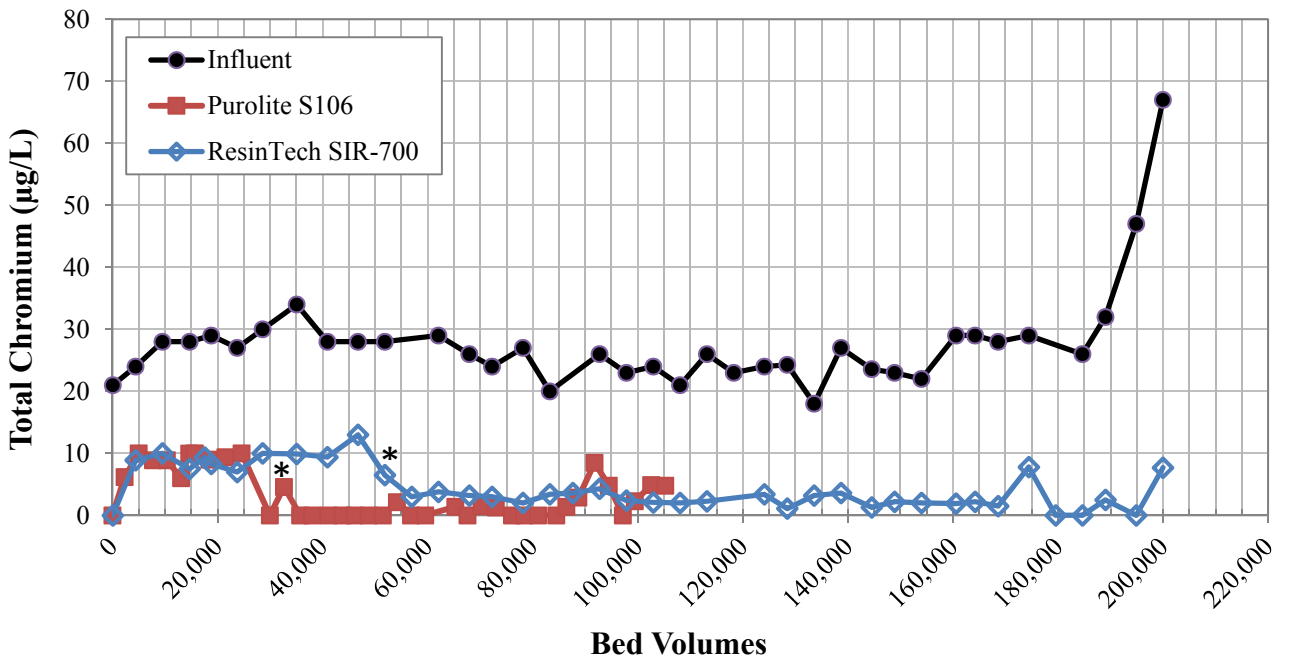

*Influent pH decreased from approximately 6.1 to approximately 5.8-5.9.

Figure 2.4 Total Cr breakthrough for Purolite S106 and ResinTech SIR-700 at Glendale

The initial Cr(VI) and Total Cr breakthrough occurred at the same time - the first two months of pilot testing- for both resins. During the second month, CO₂ was found to be underdosed, which was caused by malfunctions of the demonstration-scale CO₂ feed and pH control system. The low CO₂ dose was suspected to be related to the initial chromium breakthrough on these two WBA resins. Therefore, an additional 2-month pilot test was conducted to verify whether the initial breakthrough was caused by pH variations or effectiveness of the resin. Fresh Purolite S106 and ResinTech SIR-700 resins (different batches from the first pilot) were tested using the Glendale GS-3 source water for additional two months. During these two months, CO₂ feed was closely monitored and pH was generally in the range of 5.9 – 6.1 most of the time, with several exceptions up to 6.3 (mostly in the second half of testing period) due to operational issues with the demonstration system.

Cr(VI) and Total Cr effluent concentrations for Purolite S106 in the first test (year 2012) and the repeated test (year 2013) are compared in Figure 2.5 and Figure 2.6. The repeat test also shows an initial Cr(VI) breakthrough at approximately 1,800 BVs during the first week), which continued until approximately 13,400 BVs when Cr(VI) became non-detect. The peak Cr(VI) concentration was 6.4 µg/L during the initial breakthrough. In the first test, Cr(VI) leakage occurred from approximately 2,300 (the first sample after startup) to 30,000 BVs, part of which was accompanied by underdosing of CO₂. The repeat test confirms an initial Cr(VI) breakthrough for Purolite S106 using Glendale’s water quality even with more consistently low pH conditions, although inadequate pH control may prolong this period. Note that Dow PWA7 tested in parallel with Purolite S106 did not show any Cr(VI) or Total Cr leakage.

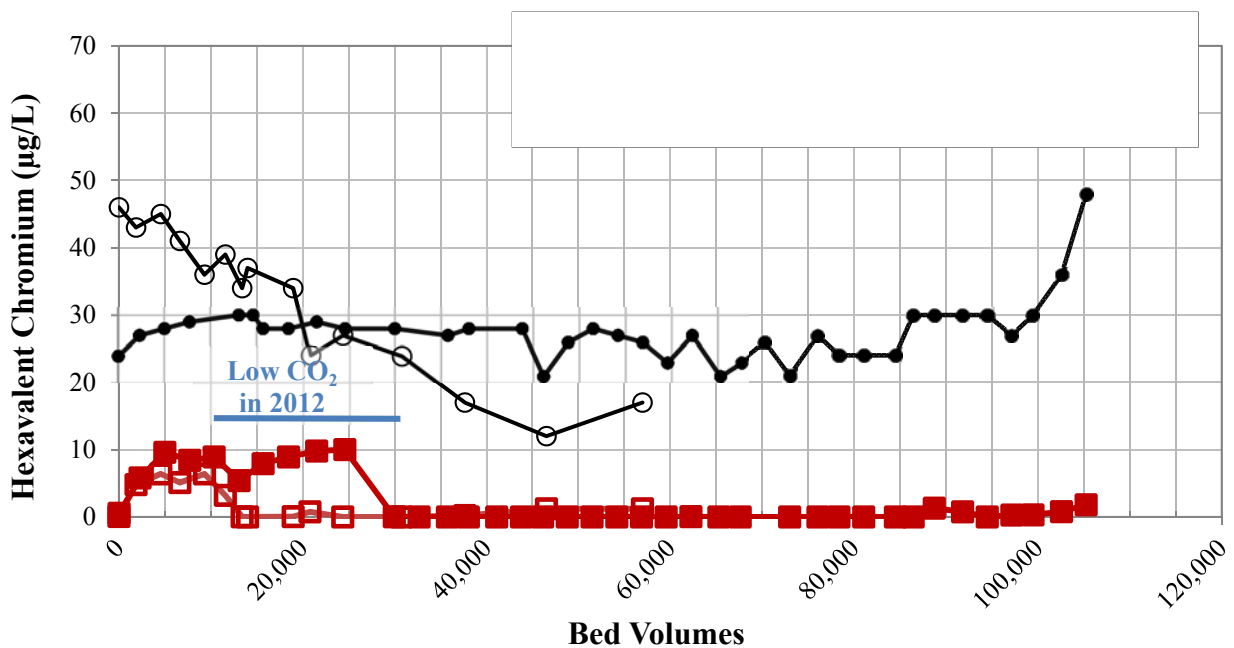

Figure 2.5 Confirmation of Cr(VI) initial leakage for Purolite S106 at Glendale

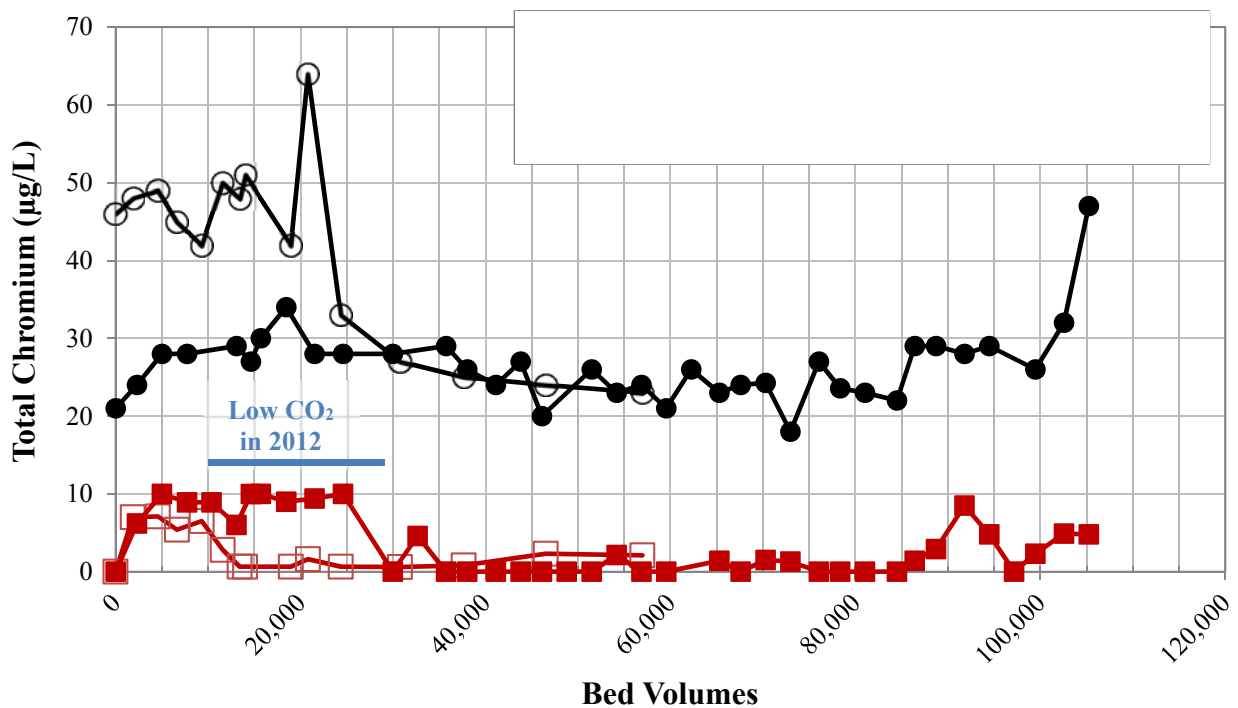

Figure 2.6 Confirmation of Total Cr initial leakage for Purolite S106 at Glendale

Figures 2.7 and 2.8 show the Cr(VI) and Total Cr concentration for ResinTech SIR-700, respectively. In the repeat test, Cr(VI) leakage was observed at approximately 3,500 BVs (the first sample after startup) and continued until 43,000 BVs. Total Cr showed a similar breakthrough curve as Cr(VI). By comparison, the initial breakthrough in a previous study (2006) and the first test in this study (2012) lasted for a greater number of BVs. The cause of the difference is not certain, but the findings are consistent that leakage occurs with this resin.

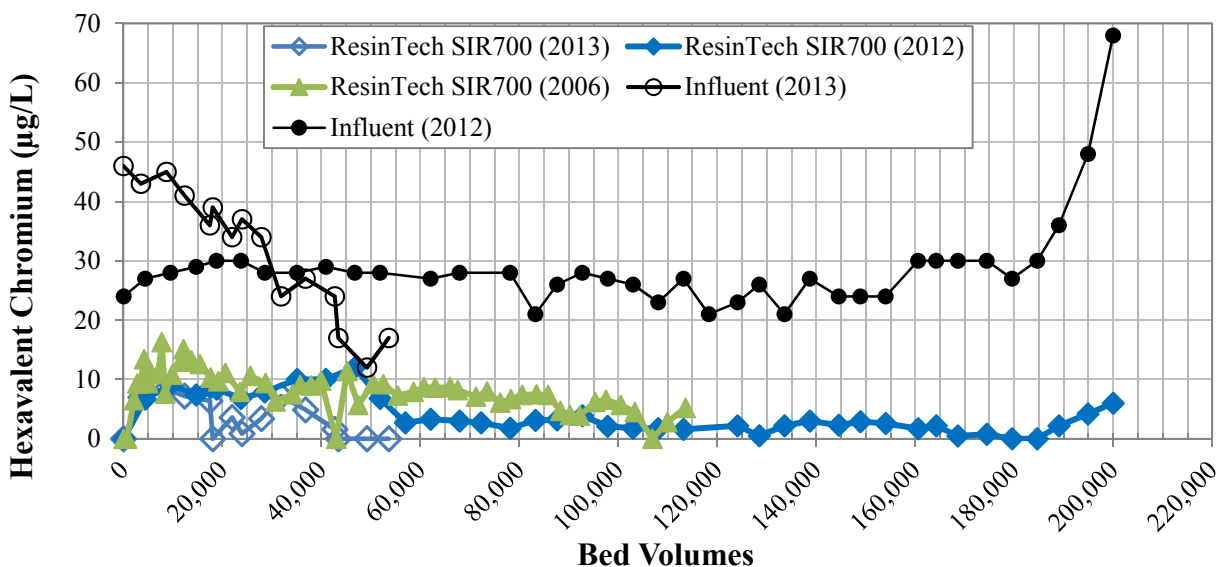

Figure 2.7 Confirmation of Cr(VI) initial leakage for ResinTech SIR-700 at Glendale

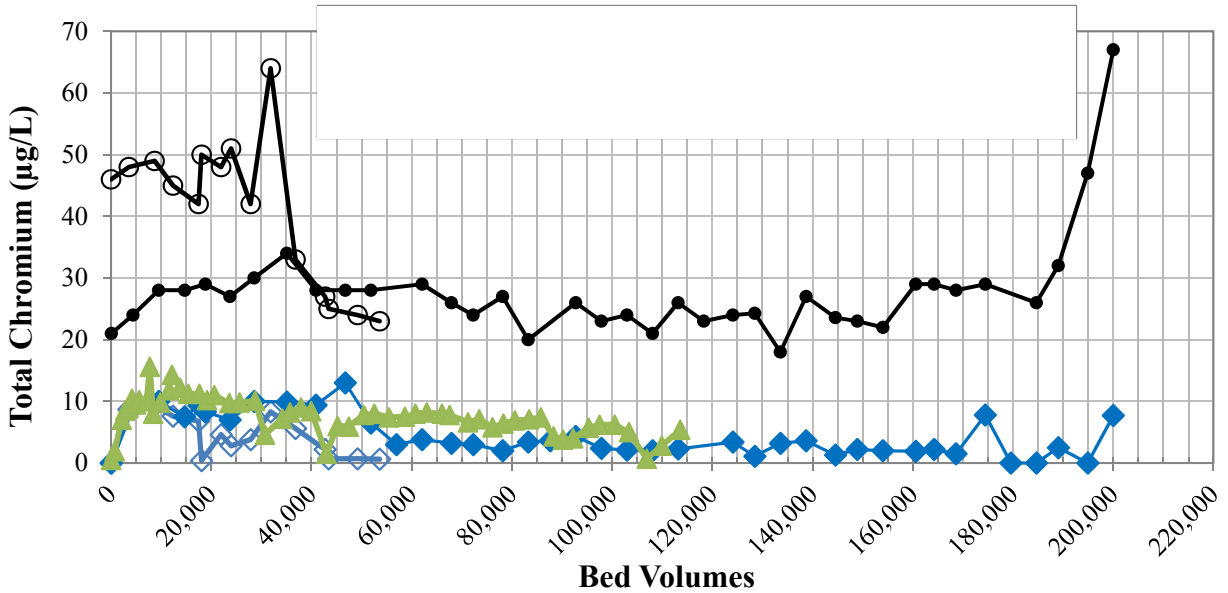
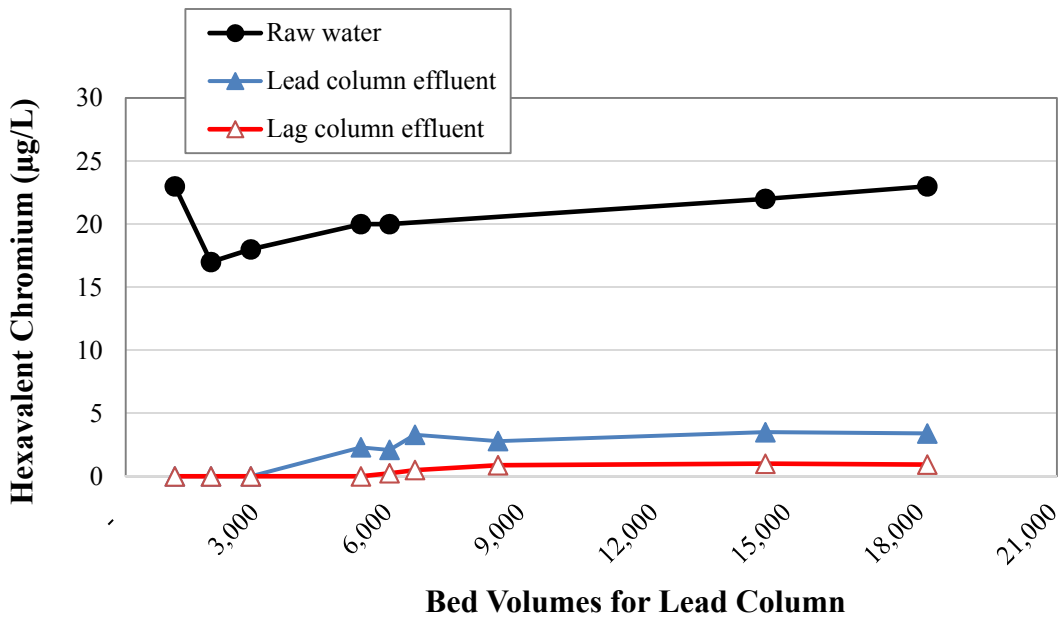

Figure 2.8 Confirmation of Total Cr initial leakage for ResinTech SIR-700 at Glendale

ResinTech SIR-700 was tested in a lead-lag configuration at Glendale to evaluate if Cr(VI) and Total Cr initial breakthrough can be controlled using this approach. This question is important if an agency is considering bypassing some of the flow and building a smaller treatment system to reach a target treatment goal. Cr(VI) breakthrough curves for the lead and lag columns are shown in Figure 2.9. Cr(VI) increased to 2.3 µg/L in the lead column effluent at approximately 5,300 BVs and slowly rose to 3.4 µg/L by 18,000 BVs. The lag column effluent showed detectable Cr(VI) (0.25 µg/L) when the lead column treated approximately 5,900 BVs of water. Cr(VI) in the lag column effluent remained below 1 µg/L by the end of testing. Total Cr breakthrough is similar to the Cr(VI) results (Figure 2.10). The results indicate that a lead-lag configuration will help to decrease the magnitude of initial Cr(VI) and Total Cr leakage.



Note: The graph is based on bed volumes for the lead column for easier comparison of the two columns. The actual bed volumes for the lag column are half of these for the lead column.

Figure 2.9 Cr(VI) breakthrough for ResinTech SIR-700 in lead-lag configuration

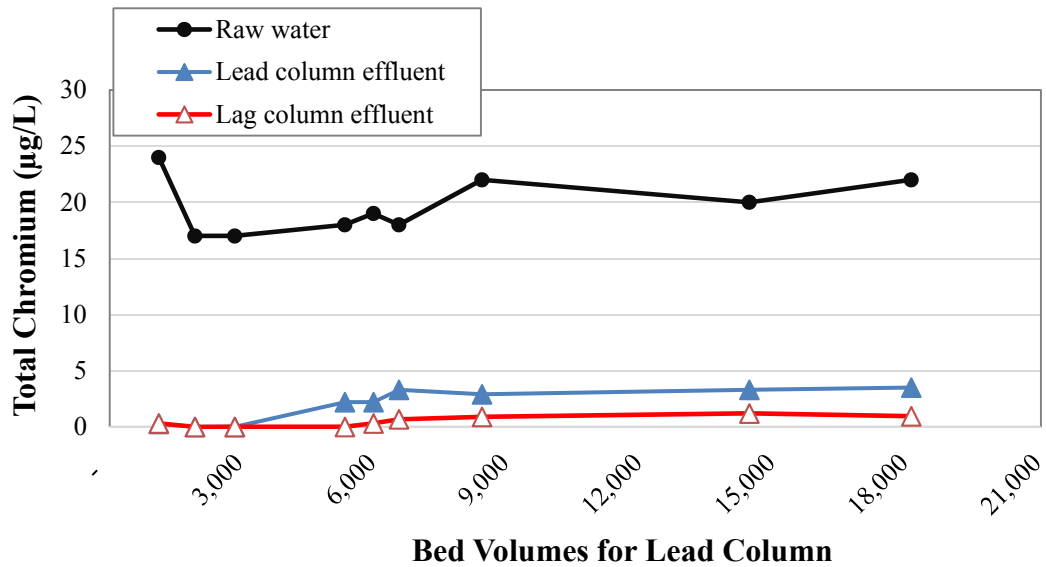

Note: The graph is based on bed volumes for the lead column for easier comparison of the two columns. The actual bed volumes for the lag column are half of these for the lead column.

Figure 2.10 Total Cr breakthrough for ResinTech SIR-700 in lead-lag configuration

Chromium Removal by Dow PWA7 at Livermore using Hydrochloric Acid for pH Adjustment

Figures 2.11 and 2.12 show Cr(VI) and Total Cr breakthrough curves for Dow PWA7 at Livermore, compared to those from demonstration-scale testing at Glendale. Hydrochloric acid was used to reduce pH to 6.0 at Livermore. Influent Cr(VI) ranged from 9.3 to 10 $\mu\text{g/L}$. Influent Total Cr ranged from 8.4 to 11 $\mu\text{g/L}$. A total of approximately 83,300 BVs were treated by Dow PWA7 during this testing before the well went offline. Resin effluent Cr(VI) was first detected (0.13 $\mu\text{g/L}$) at approximately 58,600 BVs and slowly rose to 0.22 $\mu\text{g/L}$ at approximately 83,300 BVs. Total Cr remained non-detect ($< 1 \mu\text{g/L}$) during the whole test period. By comparison, the Glendale demonstration-scale study results showed Cr(VI) breakthrough at approximately 13,500 BVs and Total Cr breakthrough ($> 1 \mu\text{g/L}$) at 3,300 BVs. The test water quality at Livermore was similar to that at Glendale for the major anions, except chromium and sulfate. It was postulated that the earlier breakthrough at Glendale may be due to higher influent Cr(VI) and Total Cr concentrations (mostly in the range of 30 to 40 $\mu\text{g/L}$).

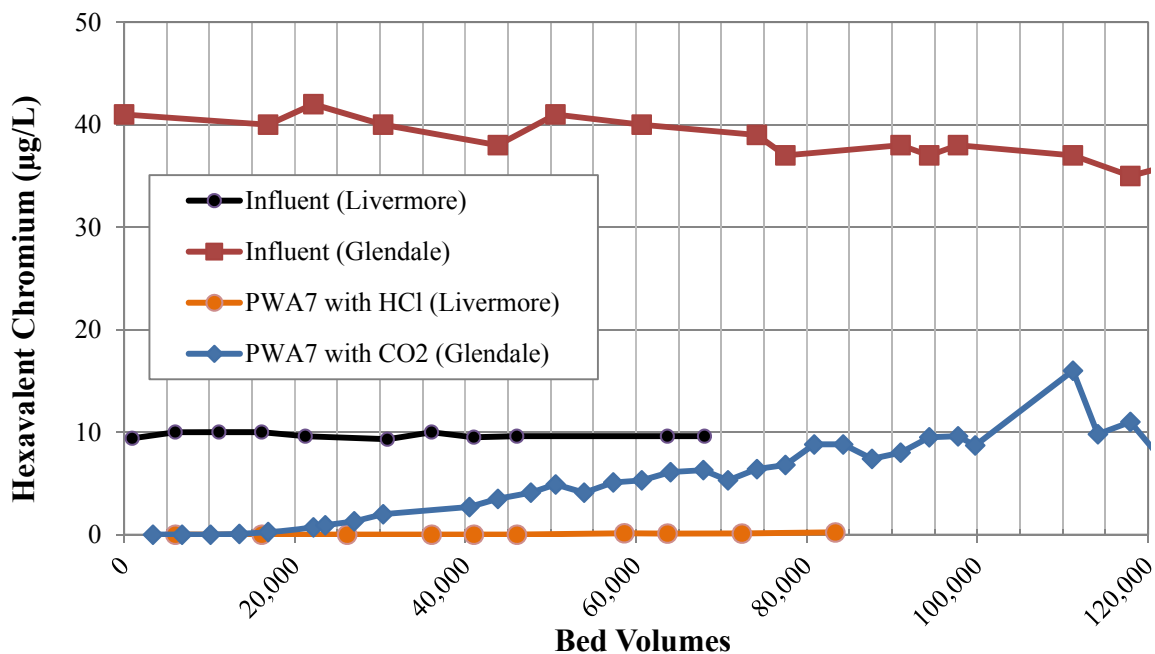

Figure 2.11 Cr(VI) breakthrough for Dow PWA7 at Livermore using hydrochloric acid for pH adjustment

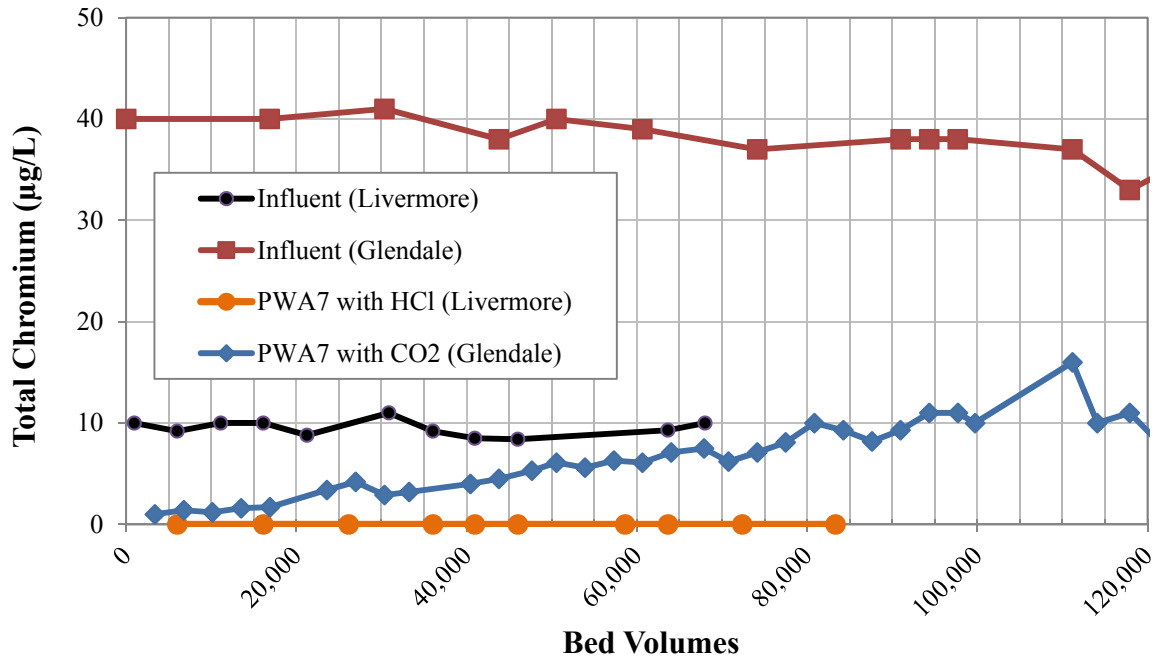

Figure 2.12 Total Cr breakthrough for Dow PWA7 at Livermore using hydrochloric acid for pH adjustment

Simultaneous Removal of Other Constituents

Other constituents monitored during the WBA pilot included nitrate, sulfate, uranium, phosphate, silica and arsenic (Table 2.7). Nitrate was removed by ResinTech SIR-700 at the startup, with the resin effluent containing 0.96 mg/L NO₃-N compared to the influent 8.1 mg/L NO₃-N. For Purolite S106, the nitrate concentration in the resin effluent during startup was 12 mg/L NO₃-N, higher than the influent, indicating nitrate peaking. Water sources with elevated nitrate concentrations may need to incorporate a multiple treatment train design operating in a staggered manner to minimize exceedance of the nitrate MCL if influent levels are close to the MCL.

For both WBA resins, sulfate was removed at startup and then reached the same level as the influent at the first monthly samples. The exact number of bed volumes when sulfate broke through cannot be estimated from this sampling frequency. The same trends were noted for phosphate. Uranium was effectively removed by both WBA resins and remained non-detect throughout the test period. Silica was not removed by either WBA resin. Arsenic removal was not determined as the influent total arsenic was non-detect.

Table 2.7
Constituents removed by Purolite S106 and ResinTech SIR-700

Water Quality Parameter	Purolite S106	ResinTech SIR-700
Nitrate	Yes, but with fast breakthrough (within 14,600 BVs)	Yes, but with fast breakthrough (within 26,600 BVs)
Sulfate	Yes, but with fast breakthrough (within 14,600 BVs)	Yes, but with fast breakthrough (within 26,600 BVs)
Uranium	Yes	Yes
Phosphate	Yes, but with fast breakthrough (within 14,600 BVs)	Yes, but with fast breakthrough (within 26,600 BVs)
Silica	No	No
Arsenic	Unknown	Unknown

Constituents Leaching

Nitrosamines were monitored at first flush and after 4 hours of operation. At the Glendale site, no nitrosamines were detected (< 2 ng/L) in either Purolite S106 or ResinTech SIR-700 resin effluent at first flush or after 4 hours of operation. At the Livermore site, NDMA was detected at levels similar to the raw water concentrations (2 - 3 ng/L) after 4 hours of operation for Purolite S106, ResinTech SIR-700 or PWA7. No other nitrosamines were detected.

Nitrosamines formation resulting from exposure of WBA-treated water to free chlorine and chloramines was also tested with resin effluents collected at first flush and after 7-days of operation. The free chlorine residual target was 2.0 mg/L. The chloramines residual target was 2.5 mg/L with a chlorine-to-ammonia ratio (Cl₂:NH₃-N) of 5:1. Both free chlorine and chloramines were tested for two contact times (1 hour and 7 days). For both Purolite S106 and ResinTech SIR-700, all eight nitrosamines analyzed were between non-detect (<0.5 ng/L) and 2 ng/L. Thus, nitrosamines formation was not found to be a concern either leaching from resins or forming in chlorinated or chloraminated water due to prior contact with WBA resins.

VOCs, SVOCs, aldehydes and ketones were monitored at first flush for all WBA resins and compared to raw water concentrations. At the Glendale site, only acetaldehyde was detected (1.7 µg/L) in the Purolite S106 effluent at a higher level than in the Glendale raw water (<1 µg/L). A low level of acetaldehyde (4.4 µg/L) was also detected in Purolite S106 effluent at first flush at the Livermore site, while it was not detected in the raw water. Acetaldehyde was also detected in ResinTech SIR-700 effluent (1.2 µg/L) and in PWA7 effluent (2 µg/L) at first flush at Livermore. No formaldehyde was detected in Purolite S106 or ResinTech SIR-700 effluent at first flush at the Glendale site. However, a low level of formaldehyde was detected in Purolite S106 effluent (7.2 µg/L) at the Livermore site, while it was not detectable in the raw water. A low level of propanal was detected (2.5 µg/L) in Purolite S106 effluent at first flush at Livermore. Dow PWA7 effluent contained 250 µg/L formaldehyde at first flush at Livermore.

Residuals Characteristics

Spent WBA resins from the Glendale site were characterized using TCLP (metals only) and California WET (TTLC and STLC). The results for Purolite S106 and ResinTech SIR-700 are summarized in Table 2.8. Both spent resins passed the TCLP test, which means they are not a federally classified hazardous waste according to Resource Conservation and Recovery Act (RCRA). However, both resins contained chromium above the California regulatory TTLC limit of 2,500 mg/kg. Thus, they would be classified as a hazardous waste for disposal in California. In addition, the vanadium concentration in ResinTech SIR-700 resin was also above the TTLC limit.

The regulatory limit for uranium is 0.05% (500 mg/kg) by weight, above which a material is classified as a radioactive waste. The uranium concentrations were 1,800 mg/kg (0.18%) and 3,000 mg/kg (0.3%) for Purolite S106 and ResinTech SIR-700, respectively. Both resins would be classified as radioactive materials (like Dow PWA7), which require special handling and disposal. The results are consistent with the sampling showing effective uranium removal from the water. The difference in uranium concentrations was due to the greater resin bed volume for Purolite S106 compared with ResinTech SIR-700. Overall, Purolite S106 and ResinTech SIR-700 spent resins are non-RCRA hazardous waste (hazardous in California) with uranium above the regulatory limit for radioactive material. Note, however, that disposal in Glendale using an absorbent material decreased uranium content below the radioactive waste threshold to the lower classification of Technologically Enhanced Naturally Occurring Radioactive Material (TENORM).

**Table 2.8
Spent WBA resins characteristics at the Glendale site**

Analyte	Purolite S106			ResinTech SIR-700			TCLP Limit (µg/L)	TTLC Limit (mg/kg)	STLC Limit (µg/L)
	TCLP (µg/L)	TTLC (mg/kg)	STLC (µg/L)	TCLP (µg/L)	TTLC (mg/kg)	STLC (µg/L)			
Antimony	N/A	<23	<1,500	N/A	<27	<1,500	N/A	500	15,000
Arsenic	<500	<23	<5,000	<500	<27	<5,000	5,000	500	5,000
Barium	<130	<120	<1,300	<130	<130	110	100,000	10,000#	100,000
Beryllium	N/A	<12	<130	N/A	<13	83	N/A	75	750
Cadmium	<13	<12	<130	<13	<13	<130	1,000	100	1,000
Chromium	330	9,900	33,000	87	13,000	28,000	5,000	2,500	5,000^
Cobalt	N/A	<120	<1,300	N/A	<130	150	N/A	8,000	80,000
Copper	N/A	360	240	N/A	530	410	N/A	2,500	25,000
Iron	N/A	620	N/A	N/A	780	N/A	N/A	N/A	N/A
Lead	< 250	8.5	95	<250	10	53	5,000	1,000	5,000
Mercury	< 1.0	0.43	<6.0	<1.0	0.48	<6.0	200	20	200
Molybdenum	N/A	130	350	N/A	130	190	N/A	3,500*	350,000
Nickel	N/A	15	<1,300	N/A	11	<1,300	N/A	2,000	20,000
Selenium	<500	<35	<5,000	<500	<40	<5,000	1,000	100	1,000
Silver	<25	<23	<250	<25	<27	<250	5,000	500	5,000
Thallium	N/A	<46	<5,000	N/A	<54	<5,000	N/A	700	7,000
Vanadium	N/A	1,100	3,400	N/A	3,000	7,500	N/A	2,400	24,000
Zinc	N/A	56	450	N/A	<130	480	N/A	5,000	250,000
Uranium	65	1,800	<13,000	290	2,600	840&	N/A	N/A	N/A

N/A – Not Applicable

< Below reporting limit, unless otherwise specified.

^ 560 mg/L if passed TCLP test

Excluding barium sulfate

* Excluding molybdenum disulfide

& Below reporting limit of 13,000 µg/L but above detection limit of 590 µg/L

Bold numbers are above the regulatory limit.

DOW PWA7 PRECONDITIONING STUDY AND OPERATIONAL SHUTDOWN TESTING OF CONSTITUENT LEACHING

One major unintended consequence in use of the WBA resin Dow PWA7 is formaldehyde leaching at startup at levels above the California notification level of 100 µg/L. Resin preconditioning is needed to minimize formaldehyde leaching. A study focusing on Dow PWA7 preconditioning to minimize formaldehyde leaching was conducted jointly by City of Glendale, Evoqua (formerly Siemens) and Dow. The technical memorandum documenting the study in detail is attached as Appendix A.

The study consisted of two parts. The first part evaluated Dow’s 2013 preconditioning procedure. Overall, the study found that the 2013 resin preconditioning procedure developed by Dow effectively reduced formaldehyde below 100 µg/L at the Siemens Facility. After the preconditioned resin was dewatered and installed at the Glendale GS-3 site, backwashed and

forward flushed, formaldehyde in resin effluent rose to above 400 µg/L and then gradually dropped to below 100 µg/L after two weeks of continuous operation. A similar trend was observed in previous full-scale resin replacements at Glendale. Column tests at Glendale showed that low water pH (6.0) may have triggered more formaldehyde leaching from preconditioned resin compared with ambient pH (7.2) water.

The second part of this study evaluated a further optimized preconditioning procedure (referred to as 2014 preconditioning procedure) based on the findings of the first part. In addition, the preconditioned resin was held saturated in pH 6 water overnight after transported and installed at Glendale. Results of the second part testing are also provided in Appendix A, showing that the 2014 procedure can keep formaldehyde levels below 100 µg/L after approximately 80 BVs of flushing (approximately 4 hours of operation). This implies that extended flushing during resin replacement may not be needed for formaldehyde leaching control. The 2014 preconditioning procedure with the approach of holding preconditioned resin saturated in low pH water is recommended for testing by agencies planning to use Dow PWA7.

Constituent leaching tests for a 72-hour shutdown showed low formaldehyde levels (<20 µg/L) from Dow PWA7 after resuming normal operation, and lower levels from Purolite S106 (≤ 3 µg/L) and ResinTech SIR-700 (≤ 2 µg/L). Before the shutdown, Dow PWA7 was operated continuously for one month, while Purolite S106 and ResinTech SIR-700 were operated for approximately three months. No significant nitrate leaching or peaking was observed for the three resins in the 72-hour shutdown test. Prior to shutdown, nitrate concentrations in the resin effluents were 7.9 to 8.0 mg/L as N. After shutdown and restart, nitrate concentrations in the resin effluents were in the range of 7.5 to 7.9 mg/L as N. No significant Cr(VI) leaching was noted in the 72-hour or 4-hour shutdowns. Cr(VI) concentrations in resin effluents were non-detect (<0.02 µg/L) to 1.5 µg/L prior to shutdown and non-detect (<0.02 µg/L) after shutdown and restart. Total Cr levels in resin effluents were slightly higher than Cr(VI) in the 72-hour shutdown for S106 (0.56 µg/L pre-shutdown and 2.5 µg/L in 15 minutes after restart) and to a lesser extent SIR-700 (0.66 µg/L pre-shutdown and 1.1 µg/L in 15 minutes after restart), suggesting low µg/L levels Cr(III) may leach from the resins after an extended shutdown. In the 4-hour shutdown test, Total Cr levels in resin effluents were all below 1 µg/L. Overall, formaldehyde, nitrate, Cr(VI) and Total Cr leaching after shutdowns were not identified as a significant concern for Dow PWA7, Purolite S106 or ResinTech SIR-700 under the conditions tested.

SUMMARY AND CONCLUSIONS

Results of this study showed that the two newer resins had a high Cr(VI) capacity and long time to breakthrough. Initial leakage of Cr(VI) and Total Cr for both Purolite S106 and ResinTech SIR-700 were observed, however. The exact bed volumes for initial leakage may vary in different runs due to water quality and pH control variations. The highest Cr(VI) concentration observed during the initial breakthrough was 6.4 µg/L for Purolite S106 and 8.4 µg/L for ResinTech SIR-700. A lead-lag configuration was promising to alleviate Cr(VI) levels during initial breakthrough, as shown in a subsequent test with ResinTech SIR700.

pH control is critical to WBA performance. Based on this study and previous demonstration-scale testing at Glendale (Blute et al., 2013b), pH above 6.0 can result in premature breakthrough as evidenced by increased Cr(VI) and Total Cr concentrations in WBA effluent. Prior bench-scale testing showed Cr(III) leakage when pH levels fall below 5.5 (Brandhuber et al., 2004). Glendale's operational experience indicates that good pH control can be achieved by monitoring online pH meter readings and carbon dioxide feed rate, and calibrating the pH meter at least once a week combined with field pH testing.

Dow PWA7 testing at Livermore showed greater resin life than at Glendale, which may be due to lower Cr(VI) concentrations at Livermore. No Cr(VI) initial breakthrough was observed until 58,600 BVs at Livermore. Hydrochloric acid was effective in reducing pH for PWA7, as observed in previous pilot testing at Glendale.

An initial resin preconditioning study showed formaldehyde leaching at startup even after preconditioning of the Dow PWA7 resin (Appendix A). Follow-up research was conducted by the City of Glendale, Dow and Evoqua to further improve formaldehyde control, showing that formaldehyde could be controlled to less than 100 µg/L with an updated procedure (Appendix A).

Simultaneous removal of other constituents was also studied in this project. Purolite S106 and ResinTech SIR-700 both effectively removed nitrate, sulfate and phosphate, although fast breakthrough occurred (less than one month – by the second sample collected). Water sources with elevated nitrate concentrations near the MCL need to consider nitrate peaking in the system design. Both resins effectively removed uranium for an extended period. Nitrosamines, VOCs, SVOCs, aldehydes and ketones leaching from Purolite S106 and ResinTech SIR-700 was either not detected or at very low levels (including acetaldehyde \leq 4.4 µg/L and propanal at 2.5 µg/L). No formaldehyde was detected in ResinTech SIR-700 effluent. A low level of formaldehyde (7.2 µg/L) was detected in Purolite S106 effluent at the Livermore site, which was less than the California notification level of 100 µg/L. Similar to Dow PWA7, both Purolite S106 and ResinTech SIR-700 spent resins are likely classified as non-RCRA hazardous waste (hazardous in California) with uranium above the regulatory limit for radioactive material (if resin operational life is not controlled on purpose or absorbent material is not used in disposal, which could limit the uranium content of the resin to less than the radioactive threshold).

CHAPTER 3: SINGLE-PASS STRONG BASE ANION EXCHANGE

This chapter summarizes the pilot-scale testing of three SBA resins (Dow SAR, Purolite A600E/9149 and Envirogen HyperSorb A3-2-1) at Glendale and Livermore, California. SBA resins can be operated either in single-pass mode (with disposal of resin) or regeneration (onsite or offsite). Regenerable SBA application is limited by the availability of brine disposal. In this study, three SBA resins were tested in a single pass mode of operation without brine regeneration. Although SBA resins have a much lower number of bed volumes before breakthrough compared with effective WBA resins for Cr(VI), SBA resins in single-pass mode may be advantageous in some cases due to a lower material cost and no need for pH adjustment to remove Cr(VI), particularly for small sites common at groundwater well locations in California.

EXPERIMENTAL METHODOLOGY

SBA Resins

The SBA resin properties are summarized in Table 3.1. Dow SAR is a Type II resin, while Purolite A600E/9149 and Envirogen HyperSorb A3-2-1 are Type I resins. These three resins are not classified as nitrate selective resins.

Table 3.1
Properties of the SBA resins

Manufacturer	Product	Type	Matrix	Functional Group
Dow	SAR	Type II	Styrene-DVB, gel	Dimethylethanol amine
Purolite	A600E/9149	Type I	Polystyrene crosslinked with divinylbenzene, gel	Quaternary ammonium
Envirogen	HyperSorb A3-2-1	Type I	Chlormethylated copolymer of styrene and divinylbenzene	Trimethylamine

Test Water Quality

The SBA test water qualities at Glendale and Livermore are summarized in Table 3.2. Cr(VI) in Glendale's water ranged from 24 to 30 µg/L; Total Cr was similar, indicating that Cr(VI) was the dominant species. For Livermore, Cr(VI) concentrations ranged from 9.3 to 10.0 µg/L, while Total Cr was similar, ranging from 8.4 to 11 µg/L. Prior data collected at Livermore for this well indicated a difference of approximately 10 µg/L in Total Cr and Cr(VI), but that difference was not observed in this testing. Both groundwaters contained moderate chloride and high nitrate concentrations. While the Glendale water had a higher sulfate concentration of 110 to 120 mg/L, the Livermore water had a lower sulfate level between 52 and 58 mg/L. Water pH was not adjusted for SBA testing.

Table 3.2
Raw water quality at Glendale and Livermore

Water Quality Parameter (unit)	Glendale* GS-3 Well		Livermore^ Well 12	
	Average	Range	Average	Range
Alkalinity (mg/L as CaCO ₃)	210	200 – 220	297	280 - 310
Arsenic, Total (µg/L)	<1	<1 – 3.3	<1	<1 – 1.1
Chloride (mg/L)	75	72 – 80	97	92 - 100
Cr(VI) (µg/L)	28	24 – 30	9.7	9.3 – 10.0
Chromium, Total (µg/L)	27.5	21 – 34	9.5	8.4 - 11
Nitrate (mg/L as N)	8.3	8.0 – 8.9	10.5	10.0 – 11.0
pH	7.0	6.8 – 7.2	7.4	7.2 – 7.5
Phosphate (mg/L as PO ₄)	0.16	0.10 – 0.18	0.25	0.24 – 0.25
Silica (mg/L as SiO ₂)	40	37 – 43	35	33 - 41
Sulfate (mg/L as SO ₄)	111	110 – 120	55	52 - 58
Temperature (°C)	20.0	16.8 – 23.6	21.8	18.4 – 25.8
TOC (mg/L)	0.53	0.43 – 0.73	N/A	0.34 [#]
TSS (mg/L)	<10	<10	N/A	<10 [#]
Turbidity (NTU)	0.34	0.09 – 0.66	N/A	N/A
Uranium (µg/L)	4.3	3.8 – 4.6	1.4	1.3- 1.5
Uranium (pCi/L)	2.9	2.6 – 3.1	0.9	<0.7 – 0.9

* Glendale test water quality is for the period of June 16 – September 20, 2012 when the SBA resins were tested.

^ Livermore test water quality is for the period of August 8 – November 8, 2012 when the SBA resins were tested.

[#] Only one sample was collected.

N/A – not analyzed or not applicable.

Pilot Unit

A pilot unit was used for SBA testing, as shown previously in Figures 2.1 and 2.2. Raw water from the wells (GS-3 at Glendale and Well 12 at Livermore) passed through a 5-micron cartridge filter to remove particles and then through a column with SBA resin. The SBA resins were tested consecutively using the same pilot column, which was cleaned between resin tests.

Operational Conditions

The operational conditions used for pilot testing of the SBA resins are summarized in Table 3.3 and were based on manufacturer recommendations and experience from previous Glendale testing. SBA resins were loaded in 2.5 inch diameter columns to a bed depth of 30-inches. The column diameter to resin bead diameter ratio of 50 is lower than a ratio of 100 recommended for filtration studies (Kawamura, 2000; McLellan et al., 2011; Lang et al., 1993) but has been shown to be effective for representing the demonstration-scale performance. In addition, Dow states that pilot columns greater than approximately 0.75 inches typically scale-up linearly with respect to predicting bed life (Dow 2012). A 2-minute EBCT was tested for the SBA resins. The hydraulic loading rate tested was 9.5 gpm/sf, which was greater than that for WBA (4.0 gpm/sf), based on recommendations from the manufacturers.

Table 3.3
SBA operational conditions

Design Parameter	Value
Column Diameter (in)	2.5
Cross Sectional Area (sf)	0.034
Bed Depth (in)	30
Bed Volume (cf)	0.09
EBCT (min)	2.0
Flow Rate (gpm)	0.32
HLR (gpm/sf)	9.5
Service Flow Rate (gpm/cf)	3.7
Daily Water Required (gal)	466
BVs per Day per Column	720
Operating pH	Same as raw water pH
Operational Mode	Down flow
Run Time	Until full breakthrough
Backwash Frequency	Backwash not necessary during study

EBCT – empty bed contact time; HLR – hydraulic loading rate; BV – bed volume.

Sampling and Monitoring

Table 3.4 summarizes the lab and field sampling and monitoring frequencies during the SBA pilot study. Cr(VI) and Total Cr were monitored weekly for raw water and three times per week for SBA effluent to capture the expected breakthrough curves. Cr(VI) and Total Cr samples were collected in pairs to assess the chromium speciation. Other constituents were monitored weekly to characterize water quality, except conductivity, TOC and TSS which were monitored monthly. pH and temperature were tested weekly in the field. Startup samples were analyzed for nitrosamines, sVOCs, VOCs, TICs, and aldehydes/ketones to determine if the resins introduce a constituent of concern. Bacteria (Total Coliform, E. Coli and HPC) were monitored initially as well, as this is a requirement for Glendale’s GAC media downstream. Each spent resin was analyzed for uranium, TCLP and CWET to assess disposal options. In addition to chemical and physical water quality analyses, process-related parameters were also recorded on a weekly basis,

including flow rate and number of BVs of water treated for each resin column. SBA testing was conducted from August to November 2012 at the Livermore site and from June to September 2012 at the Glendale site.

Table 3.4
SBA pilot sampling and analysis frequency

Analyte	Lab or Field	Raw Water	Resin Effluents	Spent Resins
Cr(VI)	Lab	W	3/W	N/A
Total Cr	Lab	W	3/W	N/A
Alkalinity	Lab	W	W	N/A
Arsenic (V)	Lab	W	W	N/A
Arsenic, Total	Lab	W	W	N/A
Calcium	Lab	W	W	N/A
Chloride	Lab	W	W	N/A
Conductivity	Lab	M	M	N/A
Nitrate	Lab	W	W	N/A
Phosphate	Lab	W	W	N/A
Silicate	Lab	W	W	N/A
Sulfate	Lab	W	W	N/A
TOC	Lab	M	M	N/A
TSS	Lab	M	M	N/A
Uranium	Lab	W	W	O
pH	Field	W	W	N/A
Temperature	Field	W	W	N/A
Nitrosamines	Lab	S*	S*	N/A
SVOCs and TICs	Lab	S	S	N/A
VOCs and TICs	Lab	S	S	N/A
Aldehydes/Ketones	Lab	S	S	N/A
Bacti	Lab	S	S	N/A
TCLP, CWET	Lab	N/A	N/A	O

*Nitrosamines sampling were conducted at first flush and after 4 hours of operation

W – weekly; 3/W – three times a week; M- monthly; N/A – not analyzed; O – Once when spent; S – Startup

Analytical Methods

The same analytical methods listed in Table 2.5 for WBA were used for SBA testing. All Total Cr samples were first analyzed without acid digestion. For Total Cr results below 5 µg/L, samples were re-analyzed with acid digestion, decreasing the potential for false positive results due to method interference at low concentrations. However, the digestion was a standard metal digestion, which was not the same as the digestion required by UCMR3 for Total Cr analysis. Thus, the MRL of the re-analyzed Total Cr samples is still considered 1 µg/L.

RESULTS

This section summarizes the pilot results of the three SBA resins at Glendale and Livermore, based on chromium removal, other constituent removal, other constituent leaching, and waste classification.

Chromium Removal

Cr(VI) and Total Cr breakthrough curves for the SBA resins tested at Glendale are shown in Figures 3.1 and 3.2, respectively. The influent Cr(VI) and Total Cr concentrations are represented by average concentrations during the SBA test period at each site. Of the three resins tested, Purolite A600E/9149 and Dow SAR showed similar capacities, followed by Envirogen HyperSorb A3-2-1. Purolite A600E/9149 effluent Cr(VI) reached full breakthrough at approximately 6,500 BVs. Dow SAR effluent Cr(VI) reached 22 µg/L at approximately 4,300 BVs ultimately increasing to 27 µg/L. Envirogen HyperSorb A3-2-1 effluent reached 20 µg/L at approximately 2,100 BVs. With a 2-minute EBCT, a total of 720 BVs of water is treated each day. Therefore, the resin life for the best performing resins to reach 10 ppb is approximately 4 to 5 days (Purolite A600E/9149 and Dow SAR). Total Cr breakthrough curves were similar to Cr(VI).

Figures 3.3 and 3.4 show the SBA Cr(VI) and Total Cr breakthrough curves at Livermore. Purolite A600E/9149 and Dow SAR showed similar capacities as at Glendale. However, both resins demonstrated higher throughput to Cr(VI) breakthrough at Livermore compared with Glendale. Cr(VI) in both resin effluents reached full breakthrough at approximately 7,600 BVs. Envirogen HyperSorb A3-2-1 effluent Cr(VI) and Total Cr reached 8.3 and 8.5 µg/L, respectively, at 860 BVs (the second sample collected). For Livermore water quality, the resin life to breakthrough (9-10 µg/L) is approximately 10 days (Purolite A600E/9149 and Dow SAR). Total Cr breakthrough curves were similar to Cr(VI).

Overall, the three SBA resins showed much lower capacities compared to WBA resins, as expected. The SBA resin capacities were higher for Livermore's water quality, which has lower sulfate and Cr(VI) concentrations. Sulfate is considered the primary factor impacting Cr(VI) removal by SBA resin.

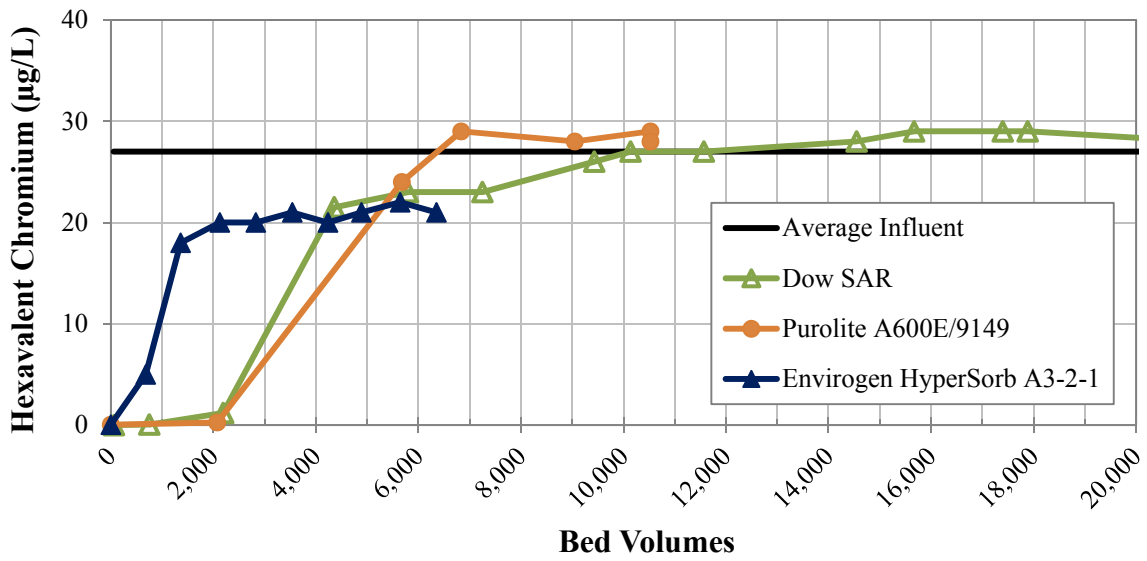

Figure 3.1 Cr(VI) breakthrough for SBA Resins at Glendale

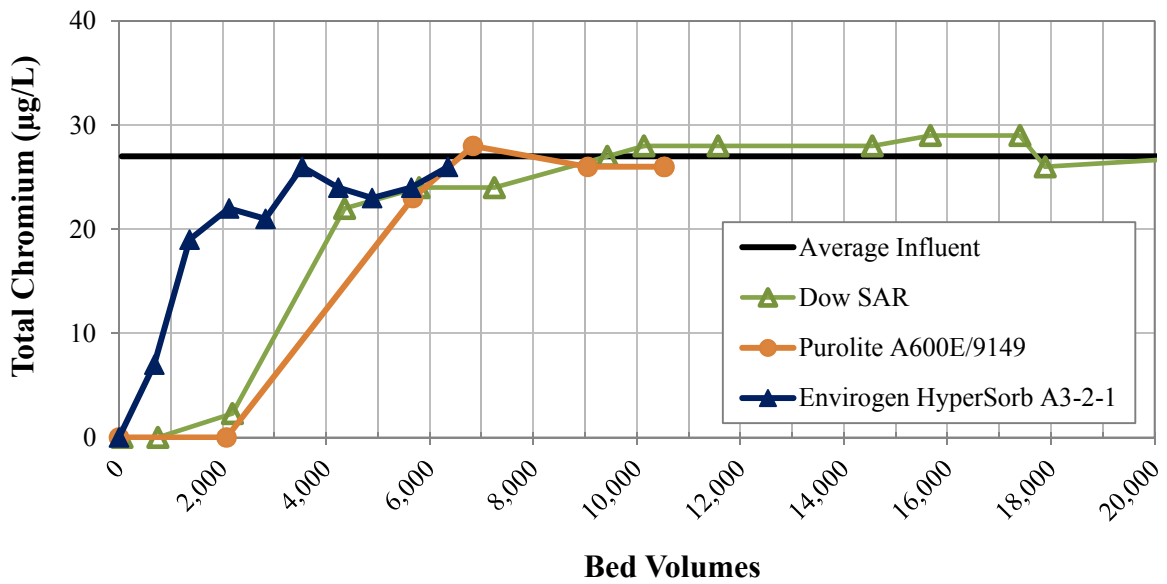

Figure 3.2 Total Cr breakthrough for SBA Resins at Glendale

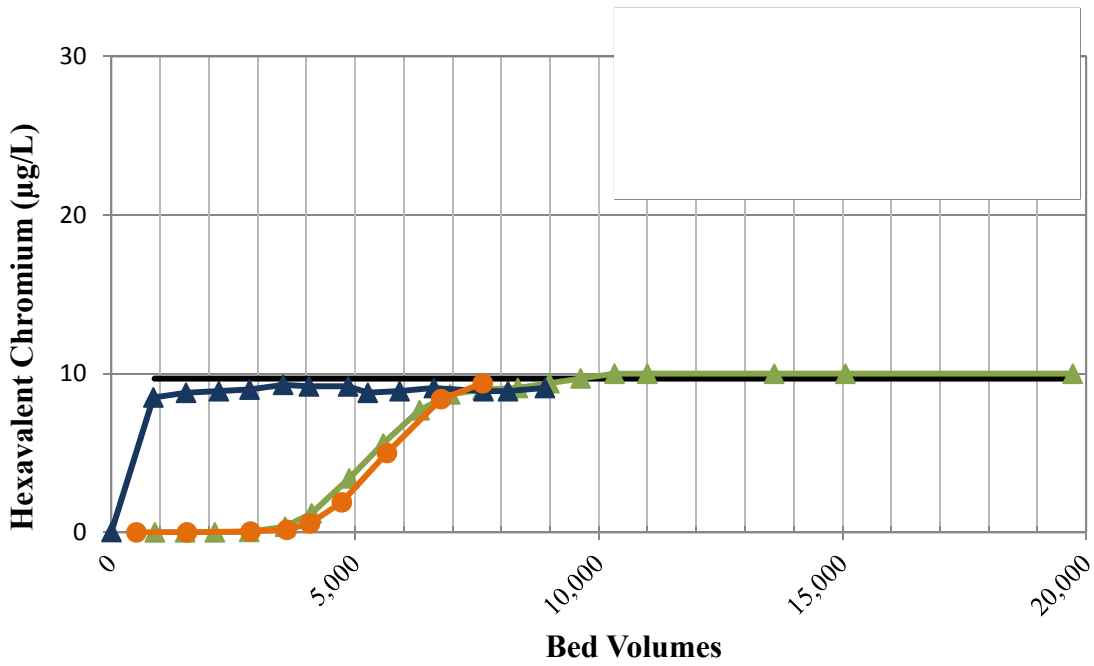

Figure 3.3 Cr(VI) breakthrough for SBA Resins at Livermore

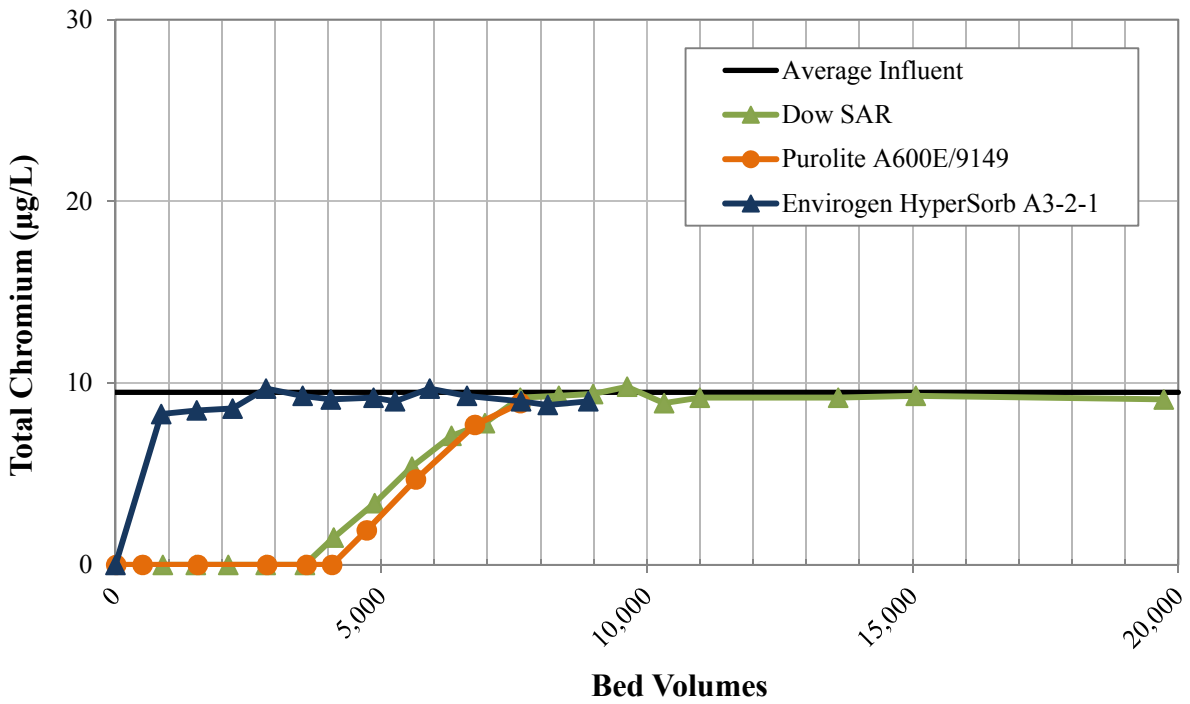

Figure 3.4 Total Cr breakthrough for SBA Resins at Livermore

Simultaneous Removal of Other Constituents

Other constituents monitored during the SBA pilot included nitrate, sulfate, uranium, phosphate, silica and arsenic. Tables 3.5 and 3.6 provide the results for Glendale and Livermore, respectively. Table 3.7 summarizes the potential removal of these constituents at Glendale and Livermore. Note that these constituents were only monitored once per week, and breakthrough might have occurred sooner than the BVs noted. Nitrate was removed by all three SBA resins, but with fast breakthrough. Sulfate was also removed by all SBA resins, with faster breakthrough than Cr(VI). Uranium was effectively removed by all SBA resins with breakthrough later than Cr(VI). Phosphate was removed but with faster breakthrough than Cr(VI). Silica was not removed by any of the SBA resins. Arsenic removal could not be determined since the influent total arsenic was below or close to the detection limits.

**Table 3.5
Constituents removed by SBA resins at Glendale**

Purolite A600E/9149						
Bed Volumes	Nitrate (mg/L as N) (Influent: 8.2 - 8.3)	Sulfate (mg/L as SO₄) (Influent: 110)	Uranium (pCi/L) (Influent: 4.2 - 4.6)	Phosphate (mg/L as PO₄) (Influent: 0.098 - 0.180)	Silica (mg/L as SiO₂) (Influent: 39 - 43)	Arsenic (µg/L) (Influent: <1)
First flush	<0.1	<0.5	NS	<0.031	39	NS
6,835	8.2	110	<0.7	0.26	40	1.1
10,528	8.3	110	<0.7	0.16	41	<1
Dow SAR						
Bed Volumes	Nitrate (mg/L as N) (Influent: 8.0 - 8.9)	Sulfate (mg/L as SO₄) (Influent: 110)	Uranium (pCi/L) (Influent: 3.8 - 4.4)	Phosphate (mg/L as PO₄) (Influent: 0.150 - 0.170)	Silica (mg/L as SiO₂) (Influent: 37 - 41)	Arsenic (µg/L) (Influent: <1 - 3.3)
58	<0.1	<0.5	<0.7	<0.031	37	<1
4,357	8.3	110	<0.7	0.16	42	<1
9,428	9.0	120	<0.7	0.16	41	1
17,884	8.3	110	<0.7	0.15	40	<1
27,902	8.2	110	<0.7	0.17	40	<1
31,111	8.0	100	<0.7	0.17	40	<1
Envirogen HyperSorb A3-2-1						
Bed Volumes	Nitrate (mg/L as N) (Influent: 8.3)	Sulfate (mg/L as SO₄) (Influent: 110)	Uranium (pCi/L) (Influent: 4.4 - 4.5)	Phosphate (mg/L as PO₄) (Influent: 0.160)	Silica (mg/L as SiO₂) (Influent: 41)	Arsenic (µg/L) (Influent: <1)
First flush	NS	2.1	<0.7	NS	NS	NS
6,352	8.6	110	4.3	0.160	40	<1

NS – Not sampled.

**Table 3.6
Constituents removed by SBA resins at Livermore**

Purolite A600E/9149						
Bed Volumes	Nitrate (mg/L as N) (Influent: 10 - 11)	Sulfate (mg/L as SO₄) (Influent: 52 - 58)	Uranium (pCi/L) (Influent: 1.3 - 1.5)	Phosphate (mg/L as PO₄) (Influent: 0.25)	Silica (mg/L as SiO₂) (Influent: 35 - 41)	Arsenic (µg/L) (Influent: <1 - 1.1)
513	10	52	NS	0.25	35	1
5,652	10	52	<0.7	0.26	35	1.1
10,240	11	55	<0.7	0.24	35	<1
14,984	11	55	<0.7	0.25	37	1
Dow SAR						
Bed Volumes	Nitrate (mg/L as N) (Influent: 10 - 11)	Sulfate (mg/L as SO₄) (Influent: 52 - 58)	Uranium (pCi/L) (Influent: 1.3 - 1.5)	Phosphate (mg/L as PO₄) (Influent: 0.24 - 0.25)	Silica (mg/L as SiO₂) (Influent: 33 - 36)	Arsenic (µg/L) (Influent: <1 - 1.2)
890	6.2	<0.5	<0.7	<0.031	34	NS
5,577	10	52	NS	0.24	37	NS
10,321	11	56	<0.7	0.24	36	<1
15,058	10	54	NS	0.25	34	<1
19,724	9.1	48	<0.7	0.25	34	NS
Envirogen HyperSorb A3-2-1						
Bed Volumes	Nitrate (mg/L as N) (Influent: 10 - 11)	Sulfate (mg/L as SO₄) (Influent: 55 - 56)	Uranium (pCi/L) (Influent: 1.4)	Phosphate (mg/L as PO₄) (Influent: 0.24)	Silica (mg/L as SiO₂) (Influent: 33 - 35)	Arsenic (µg/L) (Influent: <1)
First flush	<0.1	3.1	<0.7	<0.031	32	<1
4,857	11	56	NS	0.24	34	<1
8,895	10	55	1.3	0.24	34	<1

NS – Not sampled.

Table 3.7
Summary of constituents removed by SBA resins at Glendale and Livermore

Water Quality Parameter	Purolite A600E/9149	Dow SAR	Envirogen HyperSorb A3-2-1
Nitrate	Full breakthrough noted in the first sample collected at 513 BVs	Yes, but with fast breakthrough (within 4,357 BVs)	Yes, but with fast breakthrough (within 4,857 BVs)
Sulfate			
Uranium	Yes, no breakthrough until end of testing	Yes, no breakthrough until end of testing	Yes, breakthrough within 6,352 BVs
Phosphate	Possibly removed but with fast breakthrough (within 513 BVs)	Yes, but with fast breakthrough (within 4,357 BVs)	Yes, but with fast breakthrough (within 4,857 BVs)
Silica	No	No	No
Arsenic	Unknown	Unknown	Unknown

Note: When a constituent broke through at both sites within different numbers of bed volumes, the smaller bed volume is presented.

Constituent Leaching

As with WBA testing, SBA effluent samples were collected during startup to identify potential constituents leaching from the resins (Table 3.4, startup samples). At Glendale, Dow SAR and Purolite A600E/9149 did not leach constituents (effluent samples were non-detect or less than raw water levels). Envirogen HyperSorb A3-2-1 had detections of 15 constituents with concentrations greater than those found in the raw water (Table 3.8). Envirogen HyperSorb A3-2-1 leached similar constituents at both Glendale and Livermore (Table 3.9). At Livermore, Purolite A600E/9149 effluent had detections of di(2-ethylhexyl)phthalate and dichlorodifluoromethane at levels slightly higher than in the raw water. Dow SAR had detections of dichlorodifluoromethane at a low level as well. None of the constituents detected for the SBA resins at both sites are regulated or listed as potential constituents of concern at the federal level or in California, except formaldehyde with a notification level of 100 µg/L in California.

Table 3.8
Constituents detected in treated water from SBA resins at Glendale

Constituent	Raw Water (µg/L)	Purolite A600E/9149 Effluent (µg/L)	Dow SAR Effluent (µg/L)	Envirogen HyperSorb A3-2-1 Effluent (µg/L)
2-Butanone (MEK)	<5	<5	<5	8.2
4-Methyl-2-Pentanone (MIBK)	<5	<5	<5	6.6
Acetaldehyde	<1	<1	<1	1.3
Benzaldehyde	<1	<1	<1	110
Benzoic Acid	<50	<50	<50	100
Bromomethane (Methyl Bromide)	<0.5	<0.5	<0.5	0.53
Butanal	<1	<1	<1	64
Chloroethane	<0.5	<0.5	<0.5	1.8
Chloromethane(Methyl Chloride)	<0.5	<0.5	<0.5	12
Cyclohexanone	<1	<1	<1	17
Formaldehyde	<5	<5	<5	160
Glyoxal	<10	<10	<10	19
N-Nitrosodibutylamine (NDBA)	<2	<2	<2	12
N-Nitrosopiperidine (NPIP)	<2	<2	<2	170
Phenol	<5	<5	<5	6.8

Notes: Raw water was sampled on June 16 and August 14, 2012. The Envirogen HyperSorb A3-2-1 effluent was sampled on September 11, 2012 when resin testing was started. Only constituents for which detections were observed are listed in this table; over 169 constituents and TICs were analyzed.

Table 3.9
Constituents detected in treated water from SBA resins at Livermore

Constituent	Raw Water (µg/L)	Purolite A600E/9149 Effluent (µg/L)	Dow SAR Effluent (µg/L)	Envirogen HyperSorb A3-2-1 Effluent (µg/L)
1,2,4-Trimethylbenzene	<0.5	<0.5	<0.5	0.62
Benzaldehyde	<1	<1	<1	28
Butanal	<1	<1	<1	12
Di(2-Ethylhexyl)phthalate	<4	4.3	<4	<4
Dichlorodifluoromethane	5.7	6.5	6.1	4.3
Formaldehyde	<5	<5	<5	22
N-Nitrosodibutylamine (NDBA)	<2	<2	<2	51
N-Nitrosopiperidine (NPIP)	<2	<2	<2	6
Phenol	<5	<5	<5	5

Notes: Raw water and Dow SAR effluent were sampled on July 11, 2012. Purolite A600E/9149 and Envirogen HyperSorb A3-2-1 effluents were sampled on September 17 and October 26, 2012, respectively. Only constituents for which detections were observed are listed in this table; over 169 constituents and TICs were analyzed.

Nitrosamine formation resulting from exposure of SBA-treated water to free chlorine and chloramines was also tested in samples collected at first flush and after 7-day operation. The free chlorine residual target was 2.0 mg/L. The chloramines residual target was 2.5 mg/L with a chlorine-to-ammonia ratio ($\text{Cl}_2:\text{NH}_3\text{-N}$) of 5:1. Both free chlorine and chloramines were tested for two contact times (1 hour and 7 days). For Purolite A600E/6149, all eight nitrosamines were between non-detect (<0.5 ng/L) and 2 ng/L, except that NDMA was formed (10.6 ng/L) in the first flush sample that was chloraminated and held for 7 days. For Dow SAR, all nitrosamines were between non-detect (<0.5 ng/L) and 2.8 ng/L. For Envirogen HyperSorb A3-2-1, NDMA and other nitrosamines were non-detect in all samples (<0.5 ng/L), except NDBA and N-nitrosomorpholine (NMOR). NDBA was detected (40.4 ng/L) in the first flush without free chlorine or chloramines. Chlorination or chloramination did not result in additional NDBA formation. NMOR was detected in the range of 0.5 – 1.4 ng/L, similar to the level found in the raw water.

Residuals Characteristics

Spent SBA resins from the Glendale site were characterized using TCLP (metals only) and CWET (TTLC and STLC). The results are summarized in Table 3.10. All three spent resins passed the TCLP and CWET, indicating they would be non-hazardous waste in California. Residuals that accumulate uranium during treatment process are considered TENORM. If TENORM contains uranium above the regulatory limit for uranium of 0.05% by weight, it is classified as a radioactive waste. All three SBA resins contained uranium below the radioactive limit. Uranium concentration in spent resin is affected by the SBA resin life and uranium in the raw water. In this study, all SBA resins had a short life to breakthrough (≤ 10 days). If SBA resins can be used for a longer life, uranium concentrations may be more elevated and should be evaluated regarding their classification as TENORM or radioactive waste. Disposal options for TENORM wastes will depend on landfill-specific limits.

Table 3.10 Spent SBA resin characteristics at the Glendale site

Analyte	Dow SAR			Purolite A600E/9149			Envirogen Hypersorb A3-2-1			TCLP Regulatory Limit (µg/L)	CWET TTLC Regulatory Limit (mg/kg)	CWET STLC Regulatory Limit (µg/L)
	TCLP (µg/L)	TTLC (mg/kg)	STLC (µg/L)	TCLP (µg/L)	TTLC (mg/kg)	STLC (µg/L)	TCLP (µg/L)	TTLC (mg/kg)	STLC (µg/L)			
Antimony	N/A	<2.3	<1,500	N/A	<2.3	<1,500	N/A	<2.2	<1,500	N/A	500	15,000
Arsenic	<500	<2.3	<5,000	<500	<2.3	<5,000	<500	<2.2	<5,000	5,000	500	5,000
Barium	<130	2.3	120	<130	<12	<1,300	<130	<11	<1,300	100,000	10,000#	100,000
Beryllium	N/A	<1.2	<130	N/A	<1.2	<130	N/A	<1.1	<130	N/A	75	750
Cadmium	<13	<1.2	<130	<13	<1.2	<130	<13	<1.1	<130	1,000	100	1,000
Chromium	120	270	180	130	280	150	90	14	330	5,000	2,500	5,000^
Cobalt	N/A	<12	<1,300	N/A	<12	<300	N/A	<11	<1,300	N/A	8,000	80,000
Copper	N/A	37	290	N/A	20	<630	N/A	15	930	N/A	2,500	25,000
Iron	N/A	26	N/A	N/A	99	N/A	N/A	38	N/A	N/A	N/A	N/A
Lead	4	0.42	<2,500	<250	<2.3	<2,500	4.8	<2.2	50	5,000	1,000	5,000
Mercury	<1.0	0.025	<6.0	<1.0	<0.082	<6.0	<1.0	<0.073	<6.0	200	20	200
Molybdenum	N/A	6.5	<1,300	N/A	10	<1,300	N/A	1.5	<1,300	N/A	3,500*	350,000
Nickel	N/A	0.74	<1,300	N/A	1.1	<1,300	N/A	0.88	<1,300	N/A	2,000	20,000
Selenium	<500	1.8	<5,000	<500	1.9	<5,000	<500	<3.3	<5,000	1,000	100	1,000
Silver	<25	<2.3	<250	<25	<2.3	<250	<25	<2.2	<250	5,000	500	5,000
Thallium	N/A	<4.6	<5,000	N/A	<4.7	<5,000	N/A	<4.4	<5,000	N/A	700	7,000
Vanadium	N/A	31	<1,300	N/A	14	<1,300	N/A	4.9	<1,300	N/A	2,400	24,000
Zinc	N/A	<12	<500	N/A	<12	<500	N/A	<11	200	N/A	5,000	250,000
Uranium	<1,300	210	NT	<1,300	120	NT	<1,300	20	NT	N/A	N/A	N/A

N/A - not applicable; NT – not tested.

< Below reporting limit, unless otherwise specified

^ 560 mg/L if passed TCLP test

Excluding barium sulfate

* Excluding molybdenum disulfide

Bold numbers are above the regulatory limit.

SUMMARY AND CONCLUSIONS

In this study, three SBA resins (Purolite A600E/9149, Dow SAR and Envirogen HyperSorb A3-2-1) were tested as single-pass resins without regeneration at Glendale and Livermore. Glendale water contained relatively high Cr(VI) (28 µg/L) and high sulfate concentrations (111 mg/L). By comparison, Livermore water had lower Cr(VI) (9.7 µg/L) and sulfate concentrations (55 mg/L). The results suggest a relatively short resin life for all three resins for both water qualities, with longer performance for Livermore water (approximately 10 days) to 9-10 ppb compared with Glendale (4 to 5 days). Sulfate is known to impact Cr(VI) removal by SBA resins, which was observed in this testing as well.

Simultaneous removal of other constituents, including nitrate, sulfate, and phosphate were observed by all three resins but with faster breakthrough than Cr(VI). Nitrate peaking was not monitored in this study; however, it is expected as the three resins are susceptible to nitrate peaking. Uranium was removed with a greater selectivity than Cr(VI). No uranium breakthrough was noted for Purolite A600E/9149 or Dow SAR by the end of the pilot testing.

Testing of constituent leaching after resin installation showed that the Envirogen HyperSorb A3-2-1 had detections of 15 constituents at Glendale and 9 constituents at Livermore with concentrations greater than those found in the raw waters, including formaldehyde above the California notification level of 100 µg/L at the Glendale site (although below 100 µg/L at the Livermore site). No regulated constituents or those with notification levels in California were observed for Purolite A600E/9149 and Dow SAR.

Spent SBA resins are likely to be characterized as non-hazardous waste by federal and California standards, and therefore could be disposed of at a non-hazardous waste landfill. Uranium concentrations of the spent resins were below the regulatory limit for the conditions tested, although they may still be considered TENORM. Disposal options depend on landfill-specific limits. For some water agencies, uranium concentrations have the potential to increase above the 0.05% limit by weight if resin life is significantly longer or uranium concentration in raw water is higher. In that case, special handling and disposal would be required. SBA resins should be tested in a specific water quality to verify the uranium concentration in spent resin before full scale application.

CHAPTER 4: REDUCTION, COAGULATION AND FILTRATION

Previous demonstration-scale testing at Glendale showed that the RCF process can effectively remove Cr(VI) and Total Cr with a 45-minute reduction time and aeration to oxidize remaining ferrous iron. Jar tests at Glendale, Coachella and others (WRF #4365, WRF #4450, WRF #4445) subsequently suggested that the reduction time could be decreased. Further pilot testing at Glendale showed that ferrous oxidation by chlorine rather than ambient oxygen and aeration could be effective. This study evaluated RCF with shorter reduction times (5, 15 and 30 minutes) and chlorination for Cr(VI) and Total Cr removal at demonstration-scale.

EXPERIMENTAL METHODOLOGY

This section summarizes the test water quality, the RCF process, operational conditions, and sampling and monitoring.

Test Water Quality

Table 4.1 lists the test water quality (Glendale GN-3 Well) during the study period. The results are based on field monitoring during the RCF study, except for alkalinity and total iron which were based on monthly well monitoring. Cr(VI) concentrations ranged from 93 to 100 µg/L, with an average of 98 µg/L. Total Cr concentrations were similar to Cr(VI). Field pH readings ranged from 7.2 and 7.9, which was likely higher than the actual pH level coming from the well under pressure due to carbon dioxide off-gassing during field testing. Alkalinity was stable, with an average of 250 mg/L as CaCO₃. Total iron was 0.02 mg/L for all monthly samples. Turbidity has an average of 0.23 NTU, with a range of 0.08 – 0.82 NTU.

Table 4.1
RCF test water quality

Water Quality Parameter (unit)	Average	Range
Alkalinity (mg/L as CaCO ₃)*	250	240 – 260
Cr(VI) (µg/L)	98 [‡]	93 – 100 [‡]
Chromium, Total (µg/L)	98 [‡]	84 – 110 [‡]
pH, Field	7.5	7.2 – 7.9
Temperature (°C)	20.1	18.9 – 21.0
Total Iron (mg/L)*	0.02	0.02
Turbidity (NTU)	0.23	0.08 – 0.82

*Based on monthly monitoring from September 2013 to January 2014.

[‡]One data point is excluded, which was 4.4 µg/L for Cr(VI) and 4.8 µg/L for Total Cr on 11/19/13.

RCF Process

Figure 4.1 provides a schematic of the demonstration-scale RCF process evaluated for shorter reduction times (5, 15 or 30 minutes) and use of chlorine to oxidize residual ferrous iron. The demonstration-scale RCF process tested during years 2010-2012 was modified to provide the operational conditions for this study. The RCF process was operated at its design capacity of 100 gpm. Ferrous sulfate was injected through a static mixer into the raw water pipeline. In this study, one or two of the three serial 15-minute reduction tanks were used to provide 15 or 30 minutes of reduction times, respectively. A 5-minute reduction time was provided by bypassing all three tanks and using the previous aeration tank (without air) as the reduction tank. A new 525-gallon tank was added as the chlorine contact tank. Sodium hypochlorite was dripped directly into the chlorine contact tank. The chlorine dose was adjusted based on the remaining ferrous concentration to target a chlorine residual of 0.3 mg/L (acceptable range 0.1 to 0.5 mg/L). After chlorination, polymer was added to the rapid mixing tank downstream, which provided a 5-min contact time. Water was pumped from the progressive cavity pump to a granular media filter (2 feet of anthracite and 1 feet of sand) to remove ferric/chromium particles. Two filters were alternated (one in duty and one in standby or backwash cycle). The progressive cavity pump was part of the original design to minimize particle breakdown. The effects of a different pump type (centrifugal pump) on RCF effectiveness for chromium removal will be evaluated in a subsequent study.

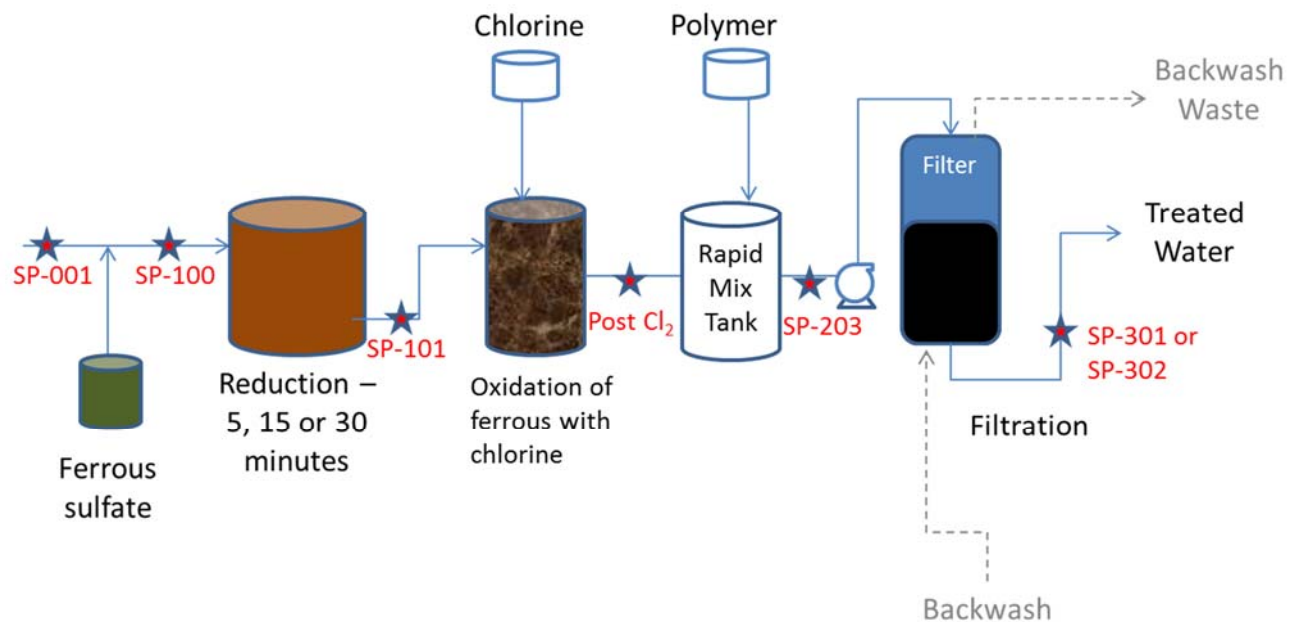

Note: Stars represent sampling locations. The same location codes were used as in previous demonstration-scale studies, with one new location added post chlorination.

Figure 4.1 Schematic of RCF process evaluated in this study

Operational Conditions

A total of four test runs were conducted with the operational conditions listed in Table 4.2 (Runs 1 through 4). A ferrous iron dose of 2 mg/L was applied in the first week of Run 1, which was selected based on previous test results with a 45-minute reduction time. However, preliminary results indicated inconsistent iron and chromium removal by the granular media filters for the lower reduction time. It was suspected that a higher ferrous iron dose might be needed with a shorter reduction time to build particles big enough to be removed by granular media filtration. Thus, the ferrous iron dose was increased to 3 mg/L beginning in the second week.

Three reduction times (5, 15 and 30 minutes) with subsequent chlorination were evaluated. Run 2 served as a control, as the condition of 30 minutes with aeration was shown to be effective in previous demonstration-scale testing at Glendale. The chlorine dose was adjusted based on the remaining ferrous concentration after reduction, with the goal of achieving a target chlorine residual of 0.3 mg/L. The polymer dose was 0.1 mg/L for all test runs. The granular media filters were backwashed every 72 hours in Run 1, which was selected based on previous test results with 45-minute reduction time and aeration. Since preliminary results showed inconsistent iron and chromium particle removal by the filters, the filters were backwashed every 24 hours to eliminate the variable of long filter run time. Each test run had at least three filter backwashes (as recommended by DDW for pilot testing of processes requiring filtration). Spent filter backwash water was allowed to settle in a storage tank with polymer addition and was further dewatered using a passive approach (SludgeMate). The treated spent wastewater was discharged to the sewer.

Table 4.2
RCF operational conditions

Run No.	Ferrous Iron Dose (mg/L as Fe)	Reduction Time (minutes)	Ferrous Iron Oxidation	Chlorine Residual Target at Chlorine Tank Effluent	Polymer Dose (mg/L)	Filter Backwash Frequency
1	3 *	5	Chlorination	0.3 ± 0.2 mg/L	0.1 ^	Every 72 hours
2	3	30	Aeration	0.3 ± 0.2 mg/L	0.1	Every 24 hours
3	3	30	Chlorination	0.3 ± 0.2 mg/L	0.1	Every 24 hours
4	3	15	Chlorination	0.3 ± 0.2 mg/L	0.1	Every 24 hours

* 2 mg/L as Fe in the first week.

^ Polymer solution was not mixed at all times as the tank mixer stopped working during this Run; normal operations resumed in Runs 2 through 4.

Sampling and Monitoring

Table 4.3 summarizes the RCF sampling and analysis frequency. Cr(VI) and Total Cr were sampled and analyzed as paired samples in raw water, rapid mixing tank effluent and filter effluent. Cr(VI) was also monitored post-reduction to ensure reduction by ferrous and at the chlorine tank effluent to determine if Cr(III) was reoxidized to Cr(VI) by chlorine. Total and ferrous iron were monitored throughout the process to verify iron dose and ensure ferrous was completely oxidized before filtration. pH and turbidity were also monitored throughout the process. In addition, bacteria (total Coliform, E. Coli, and HPC) were monitored three times a week as recommended by DDW due to positive Bacti noted in previous RCF study.

Table 4.3
RCF sampling and analysis frequency

Analyte	Lab or Field	Raw Water (SP-001)	Raw Water with Ferrous (SP-100)	Post-Reduction (SP-101)	Chlorine or Aeration Tank Effluent	Rapid Mix Tank Effluent (SP-203)	Post-Filtration (SP-301 or SP-302)
Bacti	Lab	3/W	N/A	N/A	N/A	3/W	3/W
Cr(VI)	Lab	1/D	N/A	2/D	2/D	2/D	2/D
Cr(VI)	Field	N/A	N/A	1/D	N/A	N/A	N/A
Total Cr	Lab	1/D	N/A	N/A	N/A	2/D	2/D
Free Chlorine	Field	N/A	N/A	N/A	2/D	2/D	2/D
Iron, Ferrous	Field	N/A	1/D	2/D	2/D	2/D	2/D
Iron, Total	Lab	N/A	N/A	2/D	N/A	2/D	2/D
Iron, Total	Field	1/D	1/D	1/D	1/D	2/D	2/D
HPC	Lab	3/W	N/A	N/A	N/A	3/W	3/W
pH	Field	1/D	1/D	1/D	1/D	1/D	1/D
Turbidity	Field	1/D	1/D	1/D	1/D	1/D	1/D

3/W – Three times per week; 1/D – Daily; 2/D – Twice a day, one in the morning, one in the afternoon

N/A – Not analyzed

Analytical Methods

Table 4.4 summarizes the analytical methods used in the RCF study. For Total Cr analysis, all RCF filter effluent samples were analyzed with digestion. The other Total Cr samples were analyzed without digestion as Total Cr was expected to be well above 5 ppb.

Table 4.4
Analytical methods

Analyte	Analytical Method	Method Reporting Limit
Bacti (COLI10)	SM 9221B	1.1 MPN/100mL
Cr(VI), Field	Hach Method 8023	10 µg/L
Cr(VI), Lab	EPA 218.6	0.02 µg/L
Total Cr	EPA 200.8	1 µg/L without digestion; 0.2 µg/L with digestion
Free Chlorine	Hach Method 8021	0.02 mg/L
Iron, Ferrous	Hach Method 8146	0.02 mg/L
Iron, Total	Hach Method 8008	0 mg/L
Iron, Total	EPA 200.7	0.05 mg/L
HPC	SM 9215B	1 CFU/mL
pH	SM 4500H+ B	N/A
Turbidity	SM 2130B / Hach 2100Q	0.02 NTU

EPA - United States Environmental Protection Agency; SM - Standard Methods
N/A - not applicable

RESULTS

Figure 4.2 shows Cr(VI) concentrations in reduction effluent prior to chlorination or aeration (SP-101). The influent Cr(VI) concentration ranged from 93 to 100 µg/L. With 30-minute reduction time (Run 2 and Run 3), Cr(VI) was effectively decreased to below 0.50 µg/L. With a 15-min reduction time (Run 4), Cr(VI) concentrations were slightly higher and mostly in the range of 1 to 2 µg/L. With a 5-minute reduction time, Cr(VI) concentrations were between non-detect (<0.02 µg/L) and 2.8 µg/L. Overall, the results indicate that 5 minutes can be sufficient for Cr(VI) reduction by ferrous iron to achieve a 5 or 10 µg/L treatment target, although slightly higher Cr(VI) levels were observed with shorter reduction times.

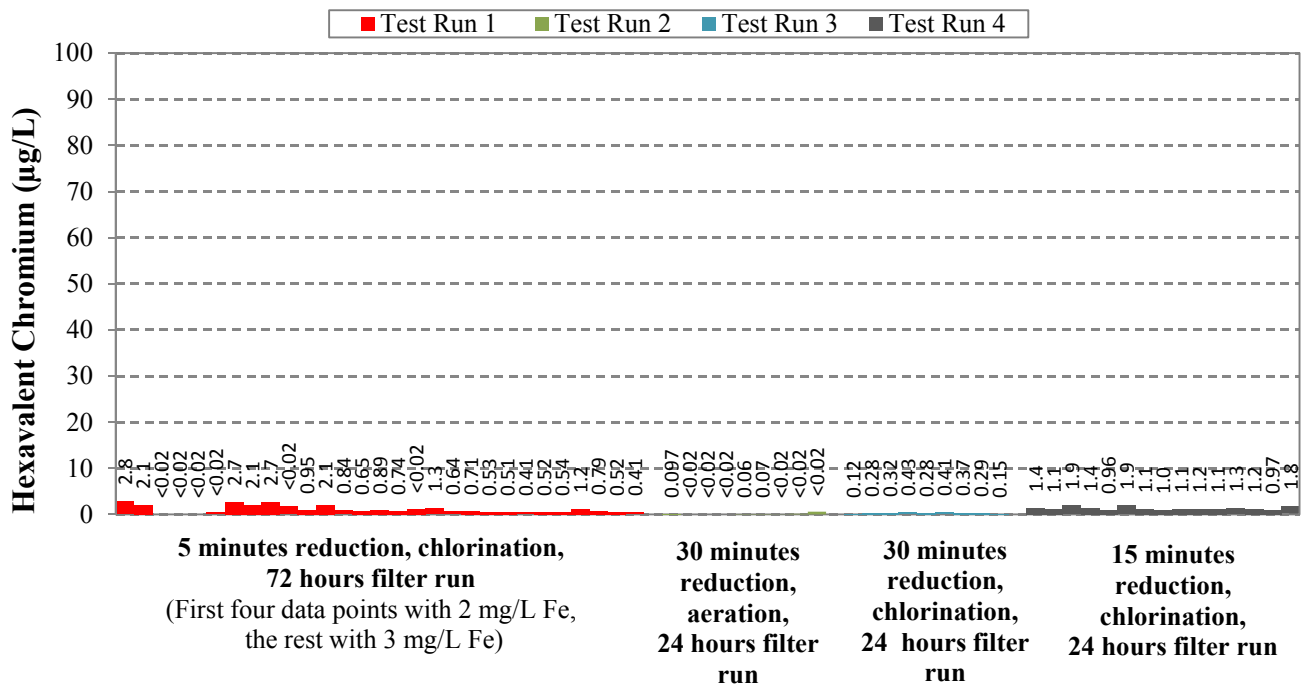

Figure 4.2 RCF post-reduction Cr(VI) with various reduction times and chlorination

Figure 4.3 shows Cr(VI) concentrations in RCF filter effluent (SP-301 or SP-302) with the tested reduction times and chlorination. In the control Run 2 (30 minute reduction time and aeration), Cr(VI) concentrations were low (<0.04 µg/L), except one data point of 68 µg/L. Considering the corresponding Cr(VI) in the reduction effluent was 0.097 µg/L and aeration does not significantly oxidize Cr(III) to Cr(VI) in these time frames, the result of 68 µg/L Cr(VI) was considered an anomalous data point.

For 30 minutes with chlorination, Cr(VI) in filter effluent was in the range of 0.5 – 17 µg/L, significantly higher than the levels in reduction tank effluent in 8 out of 10 samples. For 15 minute reduction time with chlorination, the Cr(VI) concentration in filter effluent was higher than in the corresponding reduction effluent in 11 out of 15 samples. In the 5 minute reduction time with chlorination, the Cr(VI) concentration in filter effluent was higher than in the reduction effluent in 13 out of 29 samples. Together, these results indicate that re-oxidation of Cr(III) to Cr(VI) by chlorine can occur under some of the tested conditions.

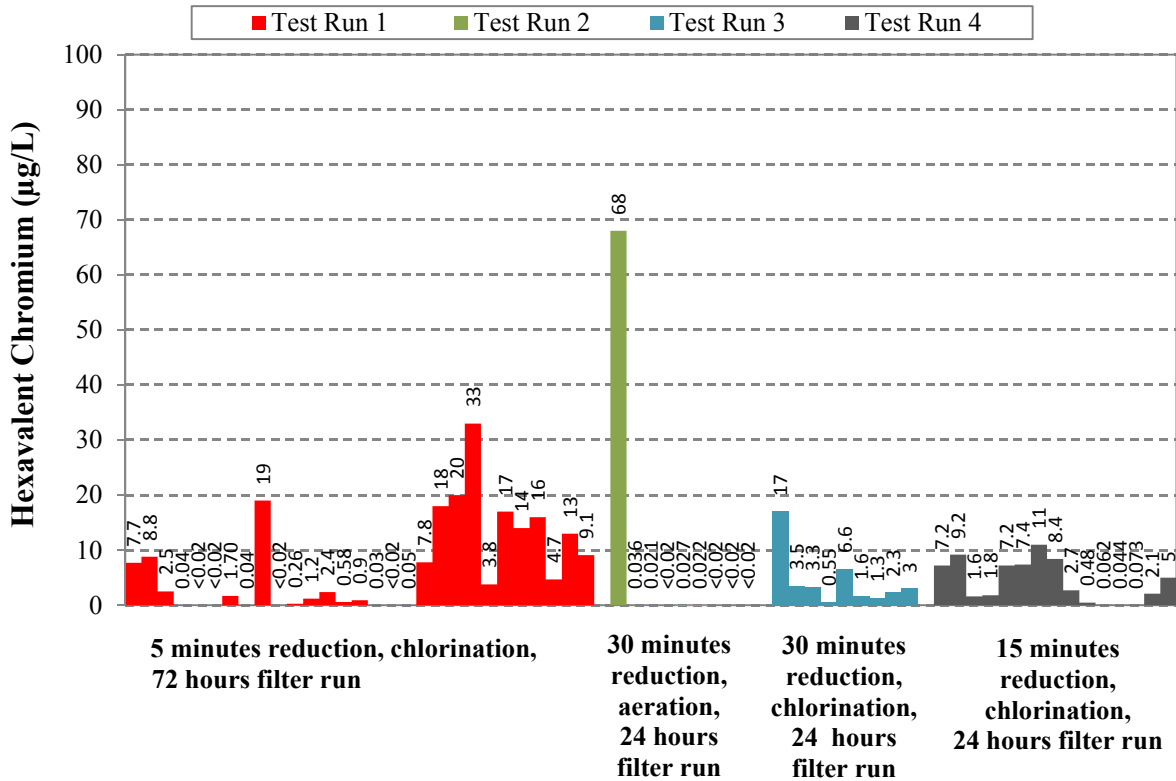

Figure 4.3 RCF filter effluent Cr(VI) with various reduction times and chlorination

Chlorine dose varied for the different runs as ferrous iron residual in the reduction effluent changed with various reduction times (Table 4.5). For example, with 5-minute reduction time, the average ferrous iron in the reduction effluent was 1.47 mg/L (ranging from 0.39 to 2.06 mg/L); with 30-minute reduction time, the average ferrous iron was 0.85 mg/L (Run 2; ranging from 0.68 to 1.11 mg/L) and 0.78 mg/L (Run 3; ranging from 0.52 to 0.98 mg/L). The chlorine dose for the 5-minute reduction time was approximately 1.5 mg/L, and the chlorine dose for the 30-minute reduction time was 1.1-1.2 mg/L.

The chlorine residual in the chlorine tank effluent greatly varied from the target residual of 0.3 mg/L ± 0.2 mg/L. Efforts were made to control the chlorine dose as much as possible, including installation of a digital peristaltic pump for consistent chlorine feed, daily chlorine feed rate adjustment, and chlorine residual monitoring twice a day. The average chlorine residual was in the target range. However, high chlorine residual levels were still noted occasionally, which might have contributed to some of the high Cr(VI) levels in the filter effluent. The chlorine monitoring and lab sampling were conducted at different times, as field monitoring was performed first to confirm normal operation. Therefore, the chlorine results were not paired with the Cr(VI) results.

Chlorine residual variations were largely due to the demonstration system configuration. Chlorine was dripped into the chlorine contact tank using flexible tubing below the water surface. In addition, the RCF process flow rate (100 gpm) was controlled by the rapid mixing tank level rather than controls on the water entering the treatment plant. Chlorine was added at a constant

rate to the tank. As a result, variations could occur in the contact time and chlorine concentrations. Additional system modifications to improve chlorine addition and mixing would be necessary to achieve a more consistent chlorine dose, which were beyond the scope of this project.

Table 4.5
RCF ferrous and chlorine dose

Run No.	Ferrous Iron Dose (mg/L as Fe)	Reduction Time (minutes)	Average and Range of Ferrous Iron in Reduction Effluent (mg/L)	Ferrous Iron Oxidation	Chlorine Dose[^] (mg/L)	Average and Range of Chlorine Residual in Chlorine Tank Effluent
1	3*	5	1.47 (0.39 – 2.06)	Chlorination	~1.5 to 2.1	0.4 (<0.02 – 2.88)
2	3	30	0.85 (0.68 – 1.11)	Aeration	~1.2	Not applicable
3	3	30	0.78 (0.52 – 0.98)	Chlorination	~1.1	0.55 (0.17 – 1.30)
4	3	15	1.06 (0.58 – 1.34)	Chlorination	~1.3	0.41 (0.10 – 2.52)

* 2 mg/L as Fe in the first week out of a total of three months test period for Run 1.

[^] The chlorine dose was slightly higher than the stoichiometric dose based on ferrous iron, including some low chlorine demand.

The effect of chlorination on ferrous oxidation is shown in Figure 4.4. In the first part of Run 1, occasional high ferrous iron levels were noted in the chlorine tank effluent, which was likely due to a chlorine feed pump capabilities. With a new peristaltic pump installed, ferrous was consistently below 0.04 mg/L. In Run 2 with aeration, ferrous iron was mostly less than 0.2 mg/L, which agrees with previous demonstration study results. In Runs 3 and 4 with chlorination, ferrous iron was below 0.04 mg/L, except in the last several days of Run 4 (which was likely due to operational challenges with maintaining consistent process flow with the pumping configuration). Overall, chlorination achieved a similar level of ferrous oxidation when compared to aeration, if not better.

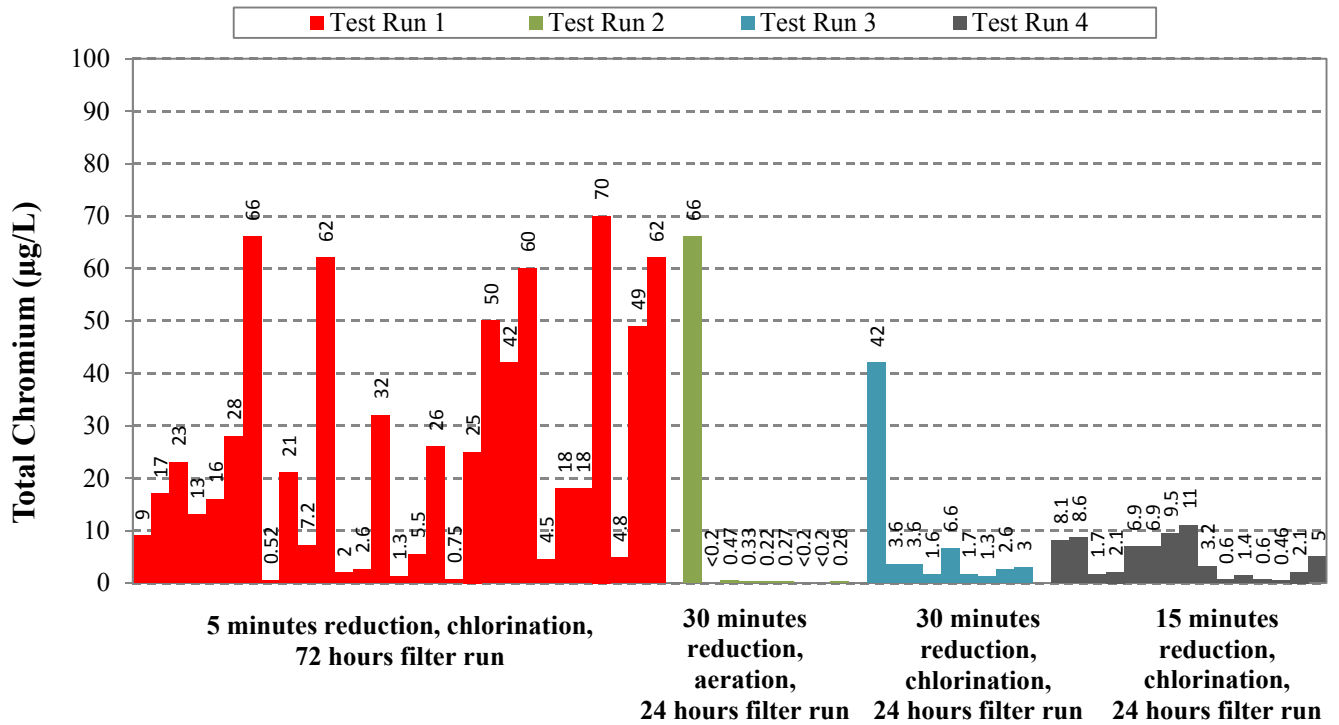

Figure 4.5 RCF filter effluent Total Cr with various reduction times and chlorination

Turbidity and total iron in RCF filter effluent are provided in Table 4.6. Turbidity levels in Run 1 were relatively high, which reflect the ineffective particle removal by filtration as discussed above. Turbidity in other runs was lower. Total iron in Run 1 also reflects the poor filter performance. Total iron concentrations in the other runs were at levels below the secondary MCL of 0.3 mg/L.

Table 4.6
RCF turbidity and total iron in filter effluent

Run No.	Turbidity (NTU)		Total Iron (mg/L as Fe)	
	Average	Range	Average	Range
1	1.06	0.18 – 3.30	0.53	0.02 – 2.00
2	0.32	0.13 – 0.53	0.02	0.02 – 0.04
3	0.56	0.17 – 1.56	0.03	0.02 – 0.06
4	0.17	0.10 – 0.30	0.02*	0.02 – 0.03*

*One data point of 0.74 mg/L total iron on 12/7/13 was excluded as Total Cr results indicate ineffective particle removal by filtration. With this data point included, the average total iron would be 0.10 mg/L.

SUMMARY AND CONCLUSIONS

RCF study results indicate that Cr(VI) was effectively reduced by ferrous iron within 5 minutes, similar to jar testing. Chlorination oxidized ferrous iron residual in the reduction effluent, with similar or better results compared with aeration. However, higher Cr(VI) concentrations were noted in filter effluent compared to pre-chlorination in a majority of the samples, indicating that Cr(III) re-oxidation by chlorine occurred. Some of these results may have been due to high chlorine residual at times, indicating the importance of tight controls on chlorine concentrations. The study results also indicate that effective filter backwash is critical for Total Cr removal, and additional backwashing capability is needed compared with the Glendale facilities.

The magnitude of Cr(III) re-oxidation is hypothesized to be affected by free chlorine residual, chlorine contact time, and Cr(III) concentration. With an iron dose of 3 mg/L and a ferrous residual ranging from 0.39 to 2.06 mg/L, a relatively large chlorine dose was needed to achieve the target chlorine residual of $0.3 \text{ mg/L} \pm 0.2 \text{ mg/L}$. Decreasing the amount of reduction time increases the amount of ferrous iron remaining and introduces more potential variability in the amount of chlorine needed for residual ferrous oxidation.

The estimated chlorine contact time from injection to filtration in the RCF demonstration facility is approximately 11 to 15 minutes. The average Cr(III) concentration in raw water was 98 $\mu\text{g/L}$, which is higher than typical Cr(VI) levels in most water sources in California. Overall, the study conditions represent a conservative scenario in which Cr(III) re-oxidation by chlorine may be more significant than might be experienced at other water agencies. Potential re-oxidation of Cr(III) when chlorine is used in place of aeration should be explored in additional testing to determine what controls work and what variability can be expected.

CHAPTER 5: ADSORPTIVE MEDIA

Adsorptive media was tested at the bench-scale for Cr(VI) removal (Brandhuber et al., 2004). The adsorptive media (sulfur modified iron, or SMI®) showed promise of high capacity compared with some media but was not ready for implementation due to operational issues including plugging of media and iron leaching. The media had reportedly evolved (SMI-III®) and was being implemented for nitrate removal elsewhere in pilot testing, so it was included in this study to evaluate Cr(VI) removal. This study initially planned to test SMI-III® at Livermore and another iron-based adsorptive media (Cleanit®) at Glendale.

SMI-III® pilot testing was intended using a pilot unit built by Loprest Water Treatment. A couple of major challenges were experienced after startup in September 2012, including media compaction and significant iron release from the media that was not captured by the existing filters. Loprest Water Treatment unloaded the media at their facility and re-loaded the media and backwashed at the Livermore site. The trailer was also upgraded with automatic backwash controls for sand filters downstream of the media filter. Unfortunately, when the Loprest pilot unit modifications were ready, the Livermore well pump experienced a series of issues and the test water was unavailable for an extended period of time. In April 2013, the decision was made by the project team and the PAC to discontinue this testing in lieu of a scope change to look at modified RCF. Information on the effectiveness of the Cleanit® media testing at Glendale would provide information on the potential for adsorptive media in this application.

EXPERIMENTAL METHODOLOGY

This section describes test water quality, the pilot unit and test conditions, sampling and monitoring, and analytical methods.

Test Water Quality

Two water sources were tested, including the GN-3 well and a blend of several GN wells at Glendale. The GN-3 well contained Cr(VI) of approximately 100 µg/L. The blend of GN wells provided a lower Cr(VI) concentration of approximately 15 µg/L. Water quality data is summarized in Table 5.1. A total of four test runs were conducted, including a trial run.

Table 5.1
Test water quality

Parameter	Trial Run		Run 1		Run 2		Run 3	
	Average	Range	Average	Range	Average	Range	Average	Range
Alkalinity (mg/L as CaCO ₃)	210*	N/A	253	240 – 260	210	200 - 220	260*	N/A
Arsenic (V) (µg/L)	< 1.0*	N/A	< 1.0	< 1.0	< 1.0*	N/A	< 1.0*	N/A
Arsenic, Total (µg/L)	< 1.0*	N/A	< 1.0	< 1.0	< 1.0*	N/A	< 1.0*	N/A
Calcium (mg/L as CaCO ₃)	93*	N/A	N/A	N/A	N/A	N/A	100*	N/A
Conductivity (µS/cm)	N/A	N/A	910	900 – 920	N/A	N/A	N/A	N/A
Cr(VI) (µg/L)	8.7	4 – 13	70	13 – 99	83	64 – 96	89	38 – 100
Chromium, Total (µg/L)	9.5	5 – 14	72	12 – 99	82	60 – 100	96	58 – 130
Iron, Total (mg/L)	< 0.02	< 0.02	< 0.02	< 0.02 – 0.10	0.04 [^]	<0.02 – 0.16	0.05	<0.02 – 0.30
Iron, Ferrous (mg/L)	0.01	0.01 – 0.02	0.01 [^]	<0.02 – 0.02	N/A	N/A	0.01 [^]	<0.02 – 0.02
Nitrate (mg/L as N)	5.8*	N/A	7.0	5.5 – 8.3	6.9	5.8 – 7.5	8.2	8.1 – 8.2
Nitrite (mg/L as N)	< 0.1*	N/A	< 0.1	< 0.1	< 0.05	< 0.05	< 0.05	< 0.05
pH (-)	7.35	7.3 – 7.4	7.2	6.5 – 6.8	N/A	N/A	7.2	7.1 – 7.4
Silica (mg/L as SiO ₂)	25*	N/A	31	31 – 32	31	29 – 32	31*	N/A
Sulfate (mg/L)	130*	N/A	107	95 – 130	93	86 – 98	98*	N/A
Turbidity (NTU)	0.23	<0.02 – 0.46	0.54	0.22 – 0.94	N/A	N/A	1.08	0.02 – 4.52
Temperature (°C)	19.5*	N/A	20.6	17.6 – 24.2	N/A	N/A	20.1	18.9 – 21.0
Uranium (µg/L)	9.2	N/A	13	12 – 16	12.7	12 – 13	13.5	12 – 15
Uranium (pCi/L)	12	N/A	9.0	7.8 – 11.0	8.5	8.2 – 8.8	N/A	N/A

* Only one sample was collected as raw water sampling was discontinued after Cr(VI) broke through in the lead column.

[^] Average calculated assuming non-detect was zero.

N/A – not analyzed or not applicable.

Pilot System

A pilot unit provided by North American Höganäs (NAH) was used in the pilot testing of Cleanit® adsorptive media (Figure 5.1 and Figure 5.2). The pilot unit consisted of two upflow 12” diameter, 36” bed depth columns in series containing Cleanit® iron composite media. The second column was intended as a polishing step. An effective particle size of 0.25 mm and a column diameter of 12” provide a ratio of column diameter to effective filter media size of approximate 1,200, exceeding the recommended value of 1,000 for minimizing sidewall effects during backwashing of granular filters (Kawamura, 2000). The process includes a strainer at the entry point to the first column. NAH initially had a 500 micron omnifilter after each column to remove large particles, but the filter was shown to rapidly clog. Instead, a small chlorine feed and macrolite filter were added for iron removal.

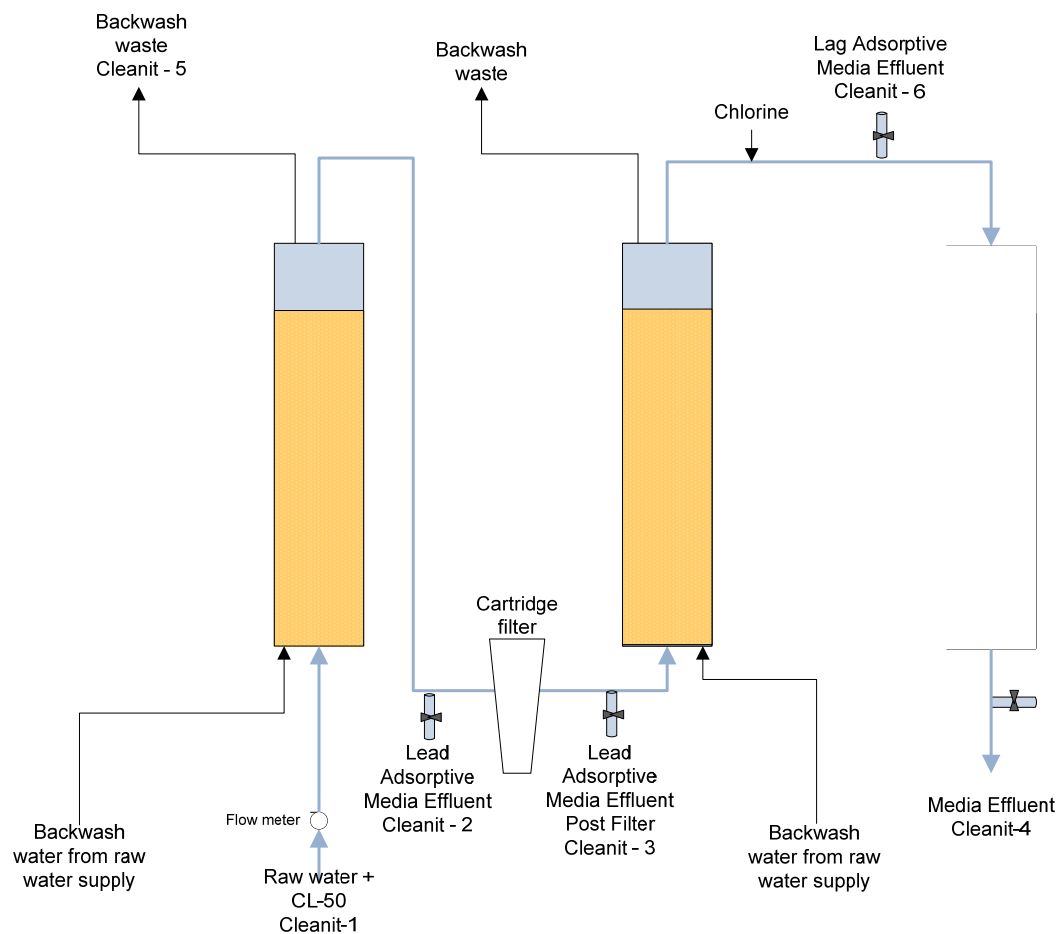

Note: Cleanit-1 through 6 represent sampling locations. Cartridge filter was removed after the media filter was installed. The media filter and chlorine were removed in Runs 2 and 3.

Figure 5.1 Schematic of Cleanit® pilot unit



Figure 5.2 Photograph of Cleanit® pilot unit

Operational Conditions

The Cleanit® pilot study consisted of four test runs, including one trial run in the beginning. The operational conditions are summarized in Table 5.2. Influent Cr(VI) concentrations varied from below 15 $\mu\text{g/L}$ to approximately 100 $\mu\text{g/L}$. Two EBCTs were tested, including 30 minutes and 15 minutes per column. Polyphosphate (NALCO CL-50, approximately 3 mg/L as PO_4) was injected to the raw water to alleviate calcium carbonate precipitation on the media. Post-filtration (downstream of the lag column) was tested in Run 1 to evaluate iron removal. Chlorine was used to oxidize ferrous iron to ferric iron, which was removed by post-filtration. Due to operational challenges (elevated pump pressure issues), post-chlorination and filtration were eliminated in Runs 2 and 3 to focus on Cr(VI) removal by the media.

Toward the end of the study, NAH also recommended periodic acid regenerations along normal operation before full breakthrough to improve media performance over time. In this study, acid regeneration was only conducted at the end of Runs 1 and 3 so that run lengths with respect to Cr(VI) removal could first be assessed. The Cleanit® column was backwashed approximately every 3 days using upflow through bed expansion.

Table 5.2
Cleanit® operational conditions and test runs

Parameters	Trial Run	Run 1	Run 2	Run 3
Test Period	5/23/12 – 6/25/12	6/26/12 - 10/31/12	2/19/13 – 4/9/13	9/17/13 – 1/29/14
Influent Cr(VI)	4 to 13 µg/L	63 – 99 µg/L [^]	64 – 96 µg/L	98 – 130 µg/L [*]
EBCT per Column	30 minutes	30 minutes, 15 minutes [‡]	15 minutes	15 minutes
Flow Rate	0.6 – 1.2 gpm	0.6 gpm, 1.2 gpm [‡]	0.85 gpm	0.55 gpm
Media Depth per Column	36 in.	36 in.	25 in.	16 in.
Configuration	Lead-lag	Lead-lag	Lead-lag	Lead-lag
Total BVs Tested	Not applicable	~6,600 BVs	~4,400 BVs	~8,100 BVs
Polyphosphate	No	Yes	Yes	Yes
Post Filtration	No	Yes	No	No
Post Chlorination	No	Yes	No	No
Operational Challenges	Media clogging due to calcium carbonate precipitation	Pump discharge pressure; iron release from media	Potential algae growth in media	Miscellaneous shutdowns
Acid Regeneration	No	At the end, after full breakthrough in the lead column	No	At the end, after full breakthrough in the lead column

[^] Except 13 – 15 µg/L in the first week.

^{*} Except one data point of 56 µg/L in the end of the second month.

[‡] 30-minute EBCT and 0.6 gpm during 6/26/12 – 8/14; 15-minute EBCT and 1.2 gpm during the rest of test period. Each run started with fresh Cleanit® media.

Sampling and Monitoring

Sampling locations for the pilot testing of Cleanit® media are shown in Figure 5.1 and represented by the label “Cleanit”. Sampling locations include raw water (designated as Cleanit-1), lead column effluent (Cleanit - 2), lag column effluent pre-filter (Cleanit-6), lag column effluent post-filter (Cleanit- 4), and backwash wastewater from the lead column (Cleanit-5). After a filter was added after the lag column, the cartridge filter between the lead and lag was removed, so initial data includes an additional point after the cartridge filter between the lead and lag columns (Cleanit-3). Table 5.3 provides the sampling and analysis frequency for the Cleanit® media. A weekly adsorptive media sampling frequency corresponds to approximately 336 bed volumes of water treated at the lead column effluent point with 30-minute EBCT or 672 BVs with 15-minute EBCT.

Table 5.3
Cleanit® adsorptive media sampling and analysis frequency

Analyte	Lab or Field	Cleanit-1 (Raw water)	Cleanit-2 (Lead Column Effluent)	Cleanit-6 (Effluent Pre- Filter)	Cleanit-4 (Effluent Post Filter)	Cleanit-5 (Backwash Waste Water)	Residuals Spent Media
Cr(VI)	Lab	W	W	W [^]	W	Once	N/A
Total Cr	Lab	W	W	W [^]	W	Once	N/A
Alkalinity	Lab	M	M	N/A	N/A	Once	N/A
Ammonia, Total	Lab	B	B	N/A	N/A	Once	N/A
Arsenic (V)	Lab	B	B	N/A	N/A	Once	N/A
Arsenic, Total	Lab	B	B	N/A	N/A	Once	N/A
Calcium	Lab	M	M	N/A	N/A	Once	N/A
Conductivity	Lab	M	M	N/A	N/A	Once	N/A
Iron, Total	Lab	W	W	W	W	Once	N/A
Nitrate	Lab	B	B	N/A	N/A	Once	N/A
Nitrite	Lab	B	B	N/A	N/A	Once	N/A
Phosphate	Lab	M	M	N/A	N/A	Once	N/A
Silicate	Lab	M	M	N/A	N/A	Once	N/A
Sulfate	Lab	B	M	N/A	N/A	Once	N/A
TSS	Lab	N/A	N/A	N/A	N/A	M	N/A
Uranium	Lab	B	B	N/A	N/A	Once	O
Iron, Ferrous	Field	W	W	W	W	N/A	N/A
pH	Field	W	W	W	W	Once	N/A
Temperature	Field	W	W	W	W	Once	N/A
Turbidity	Field	W	W	W	N/A	N/A	N/A
Nitrosamines(8)	Lab	S*	S	N/A	N/A	N/A	N/A
SVOCs and TICs	Lab	S	S	N/A	N/A	N/A	N/A
VOCs and TICs	Lab	S	S	N/A	N/A	N/A	N/A
Aldehydes/Ketone	Lab	S	S	N/A	N/A	N/A	N/A
Bacti	Lab	S	S	N/A	S	N/A	N/A
TCLP, CWET	Lab	N/A	N/A	N/A	N/A	N/A	O

W – weekly; B – biweekly; M- monthly; N/A – not analyzed; O – Once when spent; S – startup.

*Nitrosamines and nitrosamines formation potential sampling was conducted at first flush and after 4 hours of operation.

[^]Cr(VI) and Total Cr samples were only sampled twice at Cleanit-6 to verify no significant chromium removal by post filtration.

Analytical Methods

The same analytical methods as in the WBA and RCF testing were applied in the Cleanit® pilot study (Table 2.5 and Table 4.4). Total Cr was analyzed with digestion when the expected concentration was below 5 µg/L. In addition, total ammonia was analyzed using EPA method 350.1 with a MRL of 0.05 mg/L as N.

RESULTS

This section summarizes Cr(VI) removal, treated water quality, constituents leaching, and residuals characteristics for Cleanit®.

Chromium Removal

Figure 5.3 shows Cr(VI) removal to breakthrough in Run 1. Cr(VI) in the lead column effluent started breakthrough at approximately 4,500 BVs and reached 48 µg/L at 5,100 BVs. An acid regeneration was then performed for the lead column, which reduced Cr(VI) concentrations to 0.4 µg/L in the next two weekly samples. Lag column effluent Cr(VI) remained non-detect (<0.02 µg/L) throughout Run 1.

The Total Cr breakthrough curve is shown in Figure 5.4. Total Cr was detected in the lead column effluent at approximately 1,600 BVs and broke through to 66 µg/L at approximately 5,100 BVs. After the acid regeneration, Total Cr was non-detect (<0.2 µg/L) and then reached 24 µg/L by approximately 800 BVs. Total Cr in the lag column effluent (post-filtration) was non-detect (<0.2 µg/L), except two detections at approximately 2,900 BVs and 3,000 BVs. The results indicate relatively fast Cr(VI) and Total Cr breakthrough.

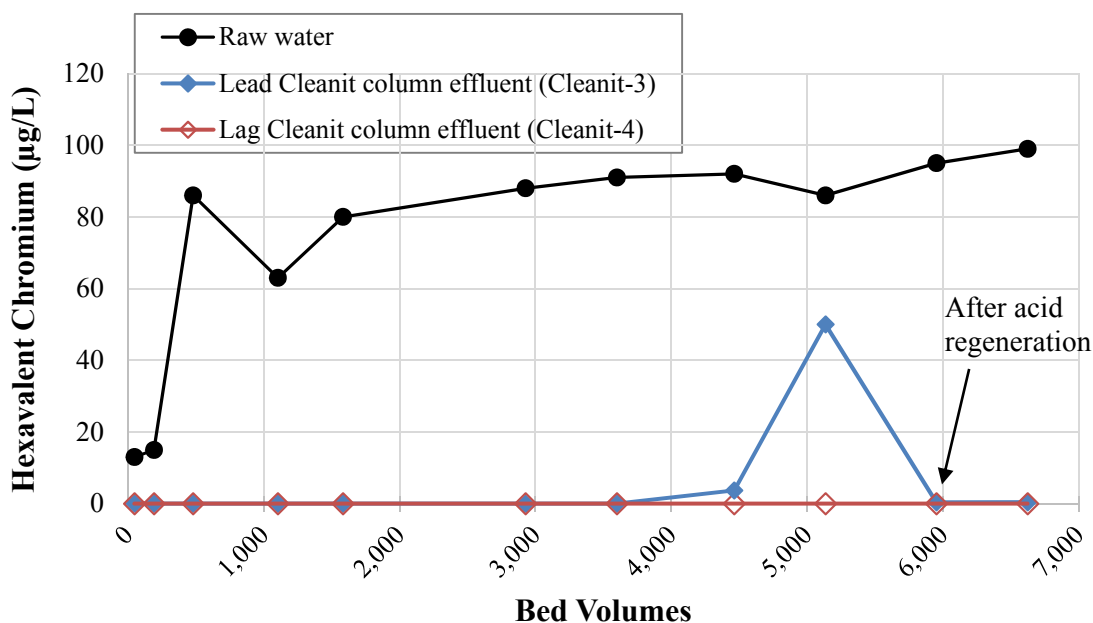

For both lead and lag columns, bed volumes are calculated as total treated water volume divided by the media bed volume in each column. EBCT was 30 minutes for the first 2,100 BVs and then reduced to 15 minutes for the rest of test period.

Figure 5.3 Cleanit® Cr(VI) breakthrough in Run 1 (30 and 15-min EBCT)

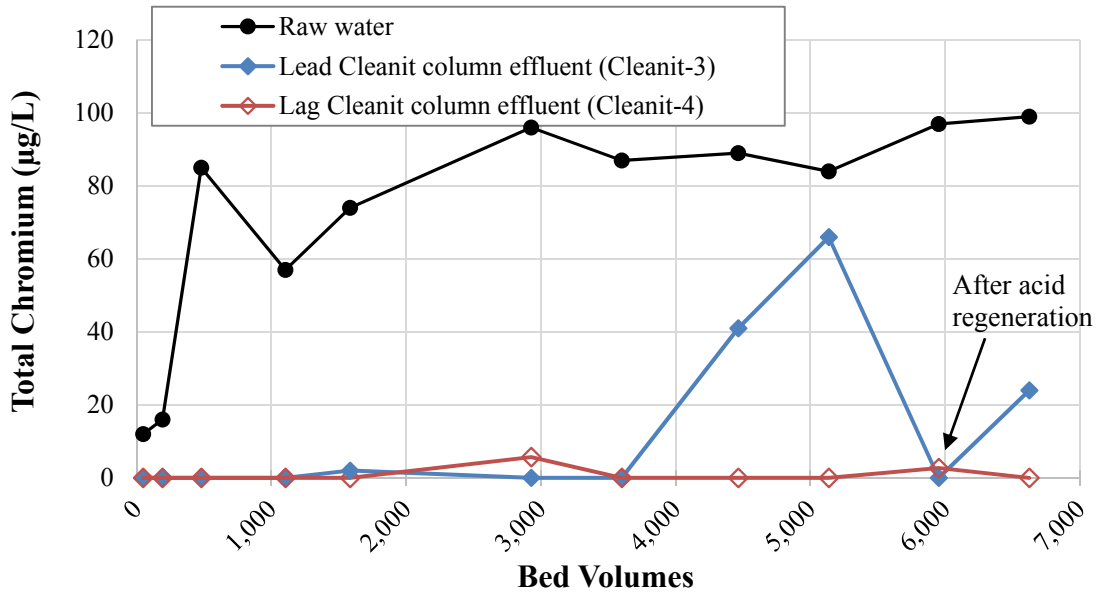

For both lead and lag columns, bed volumes are calculated as total treated water volume divided by the media bed volume in each column. EBCT was 30 minutes for the first 2,100 BVs and then reduced to 15 minutes for the rest of test period.

Figure 5.4 Cleanit® Total Cr breakthrough in Run 1 (30 and 15-min EBCT)

In Run 2, raw water was stored in a tank onsite, due to limitations at that time on a continuous feed water. The pilot process experienced several shutdowns, which were suspected to be due to algae growth in the media carried over from the tank. The pilot system was shut down for five months awaiting resumption of continuous flow at the site to eliminate the tank.

Figures 5.5 and 5.6 show Cr(VI) and Total Cr breakthrough curves in Run 2. Cr(VI) and Total Cr reach breakthrough for both columns in the first set of samples at approximately 2,100 BVs. It is unclear if the early breakthrough was due to suspected algae growth in the media or the shorter EBCT (15 minutes). A third run was conducted to repeat Run 2.

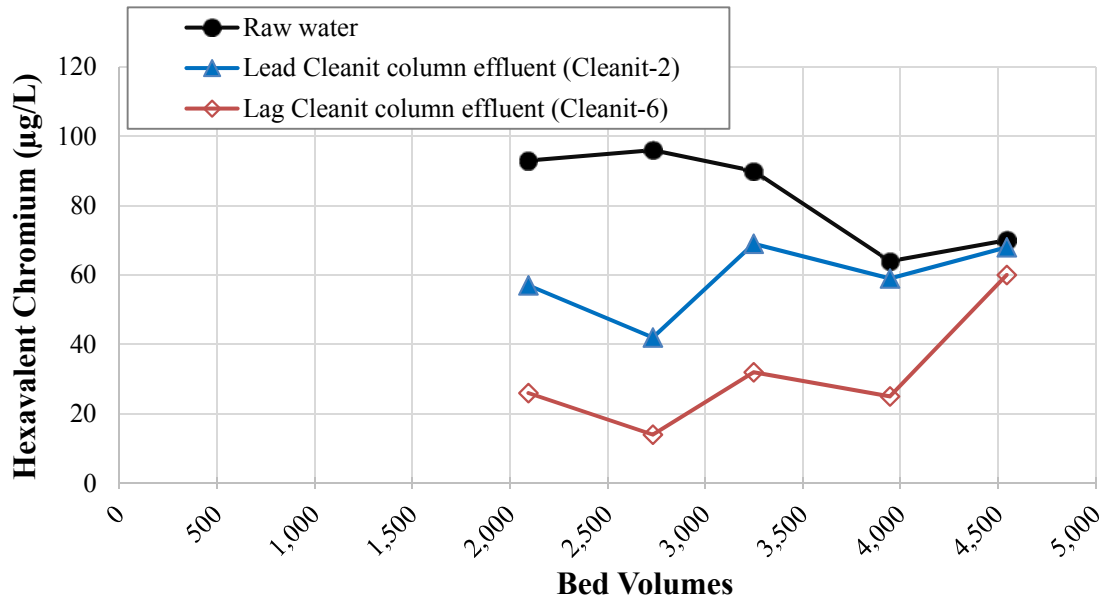

For both lead and lag columns, bed volumes are calculated as total treated water volume divided by the media bed volume in each column.

Figure 5.5 Cleanit® Cr(VI) breakthrough in Run 2 (15-min EBCT)

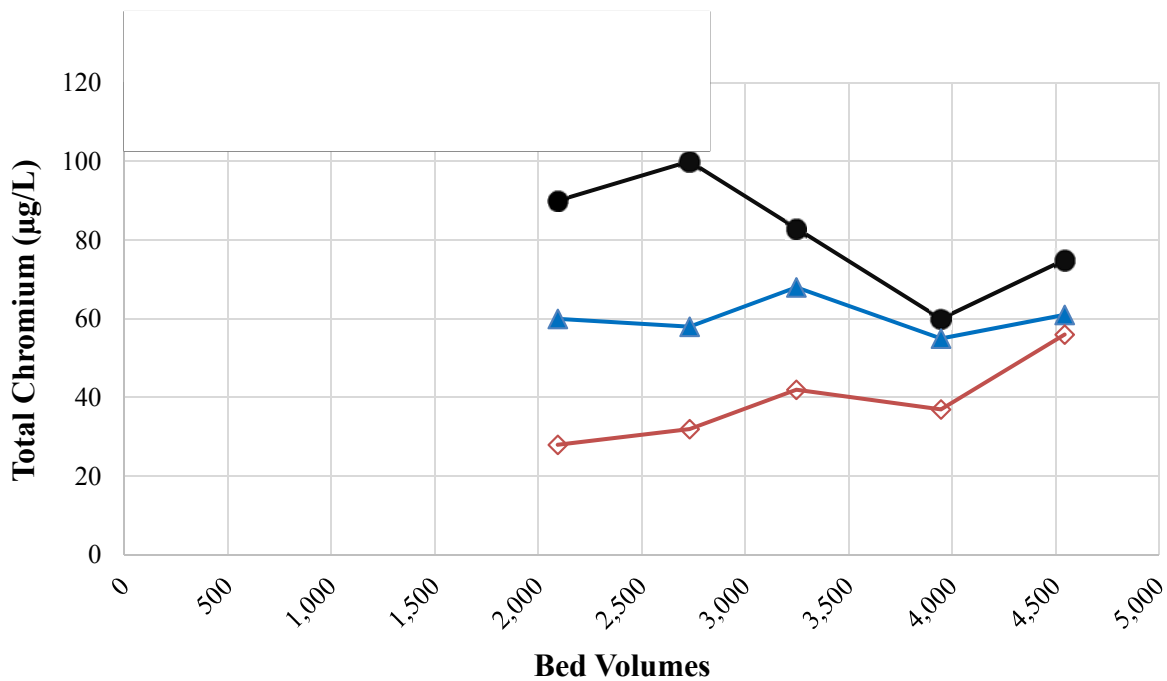

For both lead and lag columns, bed volumes are calculated as total treated water volume divided by the media bed volume in each column.

Figure 5.6 Cleanit® Total Cr breakthrough in Run 2 (15-min EBCT)

Run 3 started with fresh media and a continuous water supply without the tank. The EBCT was 15 minutes in each column. Cr(VI) and Total Cr breakthrough are shown in Figures 5.7 and 5.8, respectively. Cr(VI) in the lead column effluent was first detected as 10 $\mu\text{g/L}$ at approximately 2,400 BVs and reached full breakthrough at approximately 3,100 BVs. The lead column was regenerated with sulfuric acid. However, the follow up sample collected five days later contained 90 $\mu\text{g/L}$ of Cr(VI). Cr(VI) in the lag column effluent started to break through at approximately 3,900 BVs and then reached 17 $\mu\text{g/L}$ at 6,200 BVs. Total Cr was detected in the lead column effluent as early as at 141 BVs and reached full breakthrough at approximately 3,100 BVs. Total Cr in the lag column effluent started initial breakthrough at approximately 1,800 BVs. No post filtration was included in Run 3. Overall, Cr(VI) and Total Cr showed fast breakthrough with an 15-minute EBCT, corresponding to approximately 25 days to reach 10 $\mu\text{g/L}$ of Cr(VI) in the lead column effluent or approximately 60 days to reach 10 $\mu\text{g/L}$ of Cr(VI) in the lag column effluent. The results of the two 15-minute EBCT columns together are similar to those in Run 1 for the 30-min EBCT lead column.

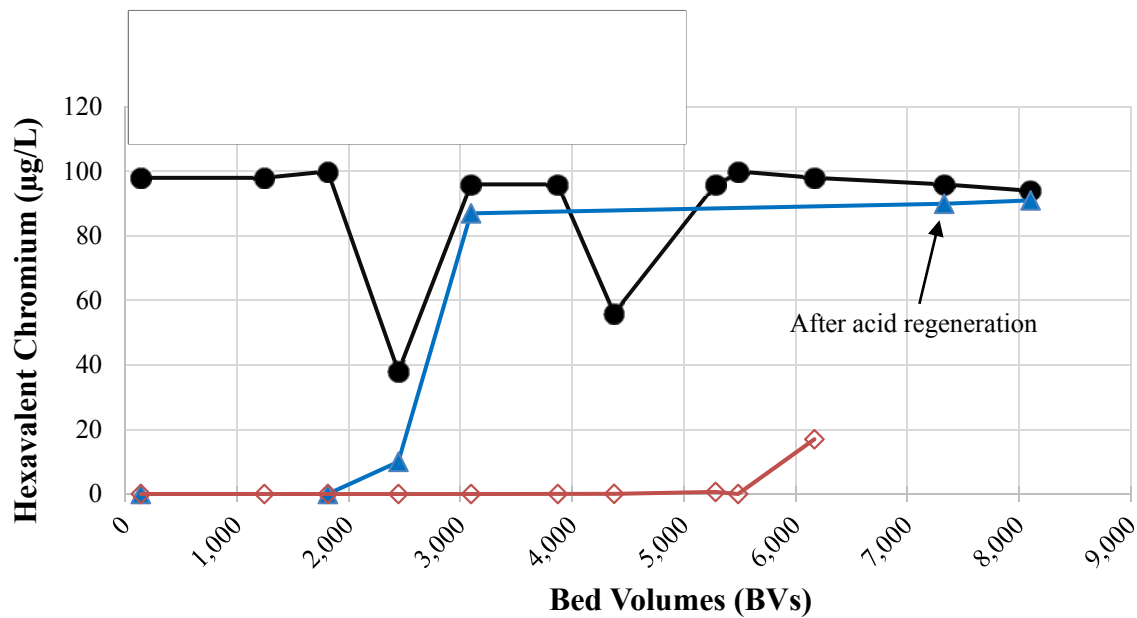

For both lead and lag columns, bed volumes are calculated as total treated water volume divided by the media bed volume in each column.

Figure 5.7 Cleanit® Cr(VI) breakthrough in Run 3 (15-min EBCT)

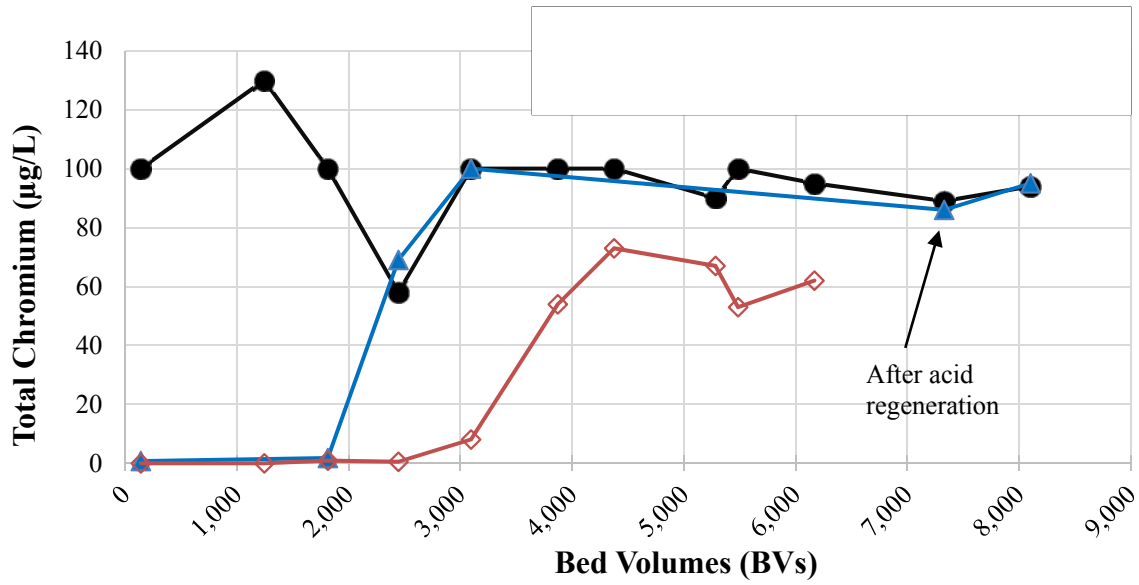

For both lead and lag columns, bed volumes are calculated as total treated water volume divided by the media bed volume in each column.

Figure 5.8 Cleanit® Total Cr breakthrough in Run 3 (15-min EBCT)

Acid Regeneration

For acid regeneration in this project, sulfuric acid was added to a water flow to reduce the water pH to 6.0. The low pH water ran through the media column at a flow rate of 1.2 gpm for 3.5 hours. In Run 1 following acid regeneration, Cr(VI) remained low (0.4 µg/L) while Total Cr reach breakthrough within approximately 800 BVs. In Run 3, the acid regeneration did not substantially restore media Cr(VI) capacity. The potential benefit of the acid regeneration was not observed in this project.

NAH reported that acid is intended to remove chromium adsorbed onto the media surface, in the process exposing new surfaces for Cr(VI) removal. NAH recommends periodic acid regeneration on a regular basis throughout normal operation. This study only tested acid regeneration at the end of Runs 1 and 3 to evaluate media performance without periodic acid regeneration since this process could be difficult for water agencies to operationally handle and dispose of the waste. The intention was that this regenerative approach (and post-filtration needs) could be explored in subsequent study if the media had showed a high capacity for Cr(VI).

Simultaneous Removal of Other Constituents

In addition to Cr(VI) and Total Cr, other water quality parameters were monitored for potential simultaneous removal by Cleanit® media. The lead column effluent water quality in Run 1 is compared to raw water quality in Table 5.4. Nitrate was removed by the media initially (0.55 mg/L as N at 190 BVs) and reached 5 mg/L as N at approximately 1,100 BVs, compared to 7 – 8 mg/L N in raw water. Nitrite concentrations in the lead column effluent were below detection limit, except for two detections at 0.17 and 0.95 mg/L as N. The potential for nitrite formation must be explored in greater depth if this media is intended for use in water with elevated nitrate, since the nitrite MCL of 1.0 mg/L as N was nearly reached.

Arsenic removal could not be evaluated since it was not present in the raw water. Silica may have been removed initially, as the first silica sample showed 27 mg/L in media effluent compared to 32 mg/L in raw water at approximately 1,100 BVs. Sulfate was not observed to be removed by Cleanit® media. Uranium was removed by Cleanit® for 3,600 BVs (9.1 µg/L in the lead effluent uranium versus 13 µg/L in raw water). pH increased through the media, which must be considered to optimize corrosion or scaling potential in finished water.

Total and ferrous iron were released from the media at high concentrations compared to the secondary MCL of 0.3 mg/L (average of 7.47 mg/L for total iron and 1.10 mg/L for ferrous iron released). Iron release arises from the nature of the permeable iron composite Cleanit® material. Post-treatment for ferrous and total iron removal would be needed in a full-scale application.

Table 5.4
Cleanit® adsorptive media effluent water quality

Parameter	Raw Water		Cleanit® Lead Column Effluent	
	Average	Range	Average	Range
Alkalinity (mg/L as CaCO ₃)	253	240 – 260	257	250 – 260
Arsenic (V) (µg/L)	< 1.0	< 1.0	< 1.0	< 1.0
Arsenic, Total (µg/L)	< 1.0	< 1.0	< 1.0	< 1.0
Conductivity (µS/cm)	910	900 – 920	873	810 – 910
Iron, Total (mg/L)	< 0.02	< 0.02 – 0.10	7.47	0.58 – 15.0
Iron, Ferrous (mg/L)	0.01 [^]	<0.02 – 0.02	1.10	0.01 – 2.66
Nitrate (mg/L as N)	7.0	5.5 – 8.3	4.14	0.55 – 8.10
Nitrite (mg/L as N)	< 0.1	< 0.1	0.22	< 0.1 – 0.95
pH (-)	7.2	6.5 – 6.8	7.9	7.2 – 8.9
Silica (mg/L as SiO ₂)	31	31 – 32	21	7 – 30
Sulfate (mg/L)	107	95 – 130	95	94 – 96
Turbidity (NTU)	0.54	0.22 – 0.94	0.49	0.24 – 0.73
Temperature (°C)	20.6	17.6 – 24.2	21.3	20.3 – 23.4
Uranium (µg/L)	13	12 – 16	6.68	< 1.0 – 14
Uranium (pCi/L)	9.0	7.8 – 11.0	4.23	< 0.7 – 9.4

[^] Average calculated assuming non-detect was zero.

Constituents Leaching

Other constituents, including nitrosamines, SVOCs, TICs, VOCs and TICs, were monitored to screen for potential constituents leaching from the media. Nitrosamines were monitored at first flush and after 4 hours of operation. NDMA was detected in the raw water at first flush, but not in the media effluent or after 4 hours of operation. Slightly higher concentrations of N-nitrosomorpholine were detected in the media effluent first flush (2.8 ng/L), compared to 2.3 ng/L in the raw water. No N-nitrosomorpholine was detected in media effluent after 4 hours of operation. Other constituents potentially released from Cleanit® are listed in Table 5.5 for effluent levels higher than in the raw water. Butanal, chloroform, cis-1,2-dichloroethylene, tetrachloroethylene and TTHM were detected at levels slightly higher than in the raw water but within acceptability ranges for analytical variation. Iron is the primary constituent that must be addressed in the Cleanit® media effluent.

Table 5.5
Cleanit® constituents leaching at initial flush*

Parameter	Raw Water	Cleanit® Lead Column Effluent
Butanal (µg/L)	< 1.0	1.1
Chloroform (Trichloromethane) (µg/L)	0.73	1.2
cis-1,2-Dichloroethylene (µg/L)	0.71	0.81
Total Iron (mg/L)	< 0.02	2.3
N-Nitrosomorpholine (ng/L)	2.3	2.8
Tetrachloroethylene (PCE) (µg/L)	83	86
Total THM (µg/L)	0.73	1.2

* Only the constituents detected in the Cleanit® lead column effluent at levels higher than in the raw water are shown.

Residuals Characteristics

Two types of residuals are generated by the Cleanit® process, including backwash water and spent media. Backwash was conducted every three days using raw water, which contained Cr(VI) at levels of approximately 100 µg/L. Backwash wastewater was characterized once during this testing; results are summarized in Table 5.6. The spent backwash water was similar in quality to the raw water, except with a higher TSS level and a lower Cr(VI) concentration. The Total Cr concentration was similar to the raw water, indicating that chromium particles were not significantly flushed from the bed during backwash.

Table 5.6
Cleanit® backwash wastewater characteristics

Parameter	Value
Alkalinity (mg/L as CaCO ₃)	250
Ammonia (mg/L as N)	0.1
Arsenic (V) (µg/L)	<1
Arsenic, Total (µg/L)	<1
Cr(VI) (µg/L)	50
Chromium, Total (µg/L)	95
Iron, Total (mg/L)	0.55
Nitrate (mg/L as N)	7.5
Nitrite (mg/L as N)	<0.05
Silica (mg/L as SiO ₂)	29
Conductivity (µS/cm)	930
Sulfate (mg/L)	99
TSS (mg/L)	15
Uranium (pCi/L)	9.4
Uranium (µg/L)	14

Cleanit® spent media characteristics are summarized in Table 5.7. All TCLP results were below the regulatory limits, indicating the spent media was not a RCRA hazardous waste.

However, the STLC chromium concentration was 13,000 µg/L compared to the California regulatory limit of 5,000 µg/L. Therefore, the spent media was classified a non-RCRA hazardous waste in California. The uranium concentration was 13 mg/kg, which is below the regulatory limit of 0.05% by weight (i.e. 500 mg/kg) and likely classifies the media as a TENORM waste.

Table 5.7 Cleanit® spent media characteristics

Analyte	TCLP (µg/L)	TTLIC (mg/kg)	STLC (µg/L)	TCLP Regulatory Limit (µg/L)	CWET TTLIC Regulatory Limit (mg/kg)	CWET STLC Regulatory Limit (µg/L)
Antimony	N/A	< 110	< 15,000	N/A	500	15,000
Arsenic	< 5,000	< 110	< 50,000	5,000	500	5,000
Barium	160	130	12,000	100,000	10,000 [#]	100,000
Beryllium	N/A	< 11	< 500	N/A	75	750
Cadmium	< 13	< 11	< 500	1,000	100	1,000
Chromium	< 250	97	13,000	5,000	2,500	5,000 [^]
Cobalt	N/A	36	< 5,000	N/A	8,000	80,000
Copper	N/A	230	< 2,500	N/A	2,500	25,000
Iron	N/A	750,000	N/A	N/A	N/A	N/A
Lead	30	17	300	5,000	1,000	5,000
Mercury	0	< 0.036	< 6.0	200	20	200
Molybdenum	N/A	33	850	N/A	3,500 [*]	350,000
Nickel	N/A	110	< 5,000	N/A	2,000	20,000
Selenium	< 5,000	< 160	< 50,000	1,000	100	1,000
Silver	< 25	< 22	< 1,000	5,000	500	5,000
Thallium	N/A	< 43	< 20,000	N/A	700	7,000
Vanadium	N/A	61	2,100	N/A	2,400	24,000
Zinc	N/A	65	< 5,000	N/A	5,000	250,000
Uranium	< 0.63	13	< 130,000	N/A	N/A	N/A

N/A - not applicable

< Below reporting limit, unless otherwise specified

[^] 560 mg/L if passed TCLP test

[#] Excluding barium sulfate

^{*} Excluding molybdenum disulfide

Bold numbers are above the regulatory limit.

SUMMARY AND CONCLUSIONS

For the Glendale water quality, Cleanit® pilot results showed effective Cr(VI) and Total Cr removal, although with relatively fast breakthrough. Frequent media replacement or regeneration might be needed (every one or two months). The shorter EBCT (15-min) would still need a larger footprint at full-scale when compared with ion exchange for a similar flow treated. In addition, iron leaching from the media resulted in concentrations significantly higher than the secondary MCL for iron, necessitating a downstream process for iron removal.

Media calcification was significant with Glendale's water quality. Polyphosphate was effective in alleviating calcification in the media. Acid regeneration conducted after full Cr(VI) breakthrough was not effective in restoring Cr(VI) capacity for a prolonged period. Nitrate, uranium and potentially silica were also removed by Cleanit® media for a short period of time. Water pH was increased by the media. No considerable contaminant leaching was detected at first flush or after four hours of operations for nitrosamines. The one waste sample analyzed indicated that the spent backwash water had similar water quality to the fresh backwash water. Spent media was non-RCRA hazardous waste due to chromium concentration above the STLC regulatory limit, and may be TENORM waste.

Compared with SBA that has a similar number of bed volumes of treatment for Cr(VI) before replacement or regeneration, the Cleanit® process would have a larger footprint due to higher EBCT and iron removal process. However, the media may be worth additional testing if removal of co-occurring constituents like nitrate is desired. Further pilot testing would be necessary to understand long term performance of the media and identify ways to overcome formation of nitrite at levels near or exceeding the MCL.

CHAPTER 6: COST ESTIMATES

Cr(VI) treatment costs were developed for WBA and RCF in the previous study by the City of Glendale and published in the project report (Blute et al., 2013b). Based on the results of this study, the Cr(VI) treatment costs were updated to reflect new developments proven to be effective, including WBA using ResinTech SIR-700 and Purolite S106, and RCF with 15-minute reduction time and chlorination in the place of aeration. This chapter summarizes the updated Cr(VI) treatment costs for WBA and RCF, including capital, annual O&M and 20-year net present value (NPV). Detailed costs are provided in Appendix B. Similar treatment costs for SBA will be developed in subsequent research at Glendale, in partnership with the Metropolitan Water District of Southern California.

METHODOLOGY

The capital and O&M costs developed in the previous study (Blute et al., 2013b) were updated using the approach illustrated in Figure 6.1. The capital cost factors and engineering factors are summarized in Tables 6.1 and 6.2, respectively. Details are described in the report published by the City of Glendale (Blute et al., 2013b). Costs are updated for three flow rates, 100 gpm, 500 gpm and 2,000 gpm. All costs are adjusted from 2012 to 2014 dollars using Engineering News-Record (ENR) indices for Los Angeles, California.

The expected level of accuracy for the cost estimates presented in this section is classified by the Association for the Advancement of Cost Engineering International (AACE) as an International Class 5 estimate. Typical uses for Class 5 estimates include assessment of initial viability, evaluation of treatment trains, and long range capital planning. Accuracy ranges for Class 5 estimates are -20% to -50% on the low side, and +30% to +100% on the high side. A typical rate of -30% to +50% was applied to the cost estimates in this report to demonstrate the accuracy range of estimates.

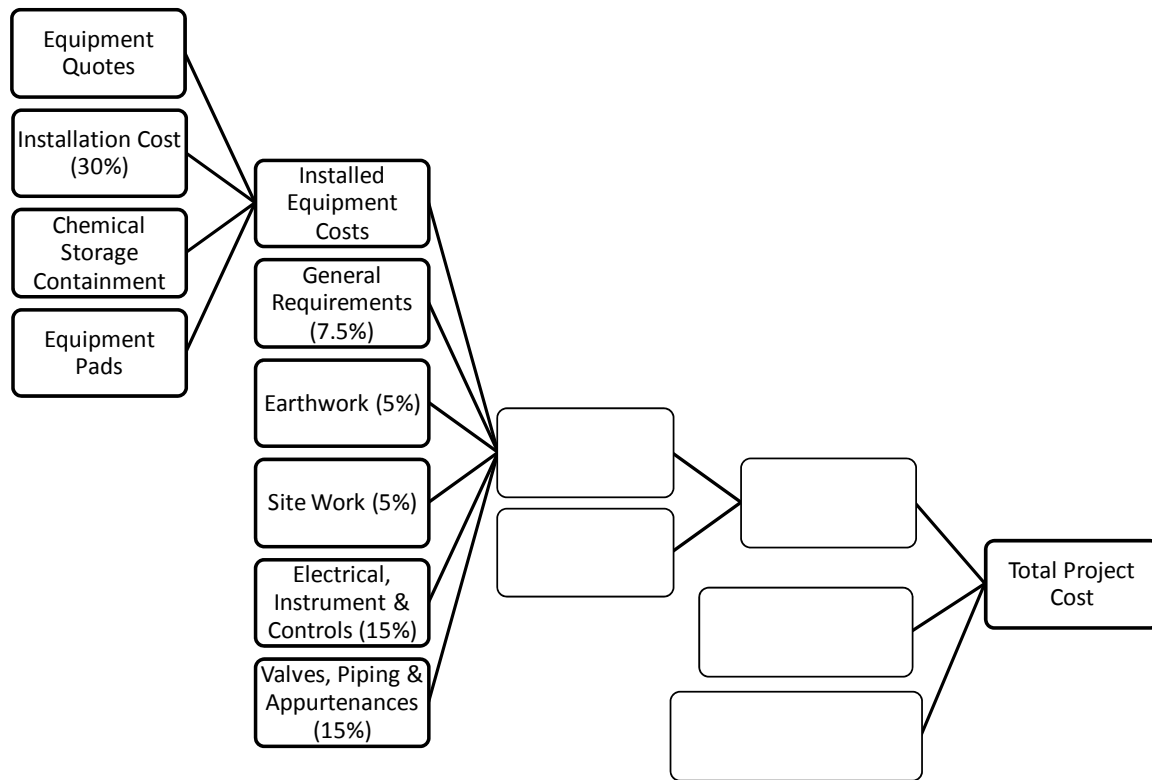

Figure 6.1 Approach for developing WBA and RCF estimates

**Table 6.1
Capital cost factors assumptions**

Item	Percentage	Description
General Requirements	7.5%	“Division 1” requirements including labor supervision, field offices, temporary utilities, health and safety, office supplies, clean up, photographs, survey, erosion control, coordination, testing services, and record documents
Earthwork	5%	Excavation, backfill, and fill required to construct the project
Site Work	5%	Roadways, curb and gutter, sidewalk, and landscaping
Valves, piping, and appurtenances	15%	Major system piping and valves
Electrical, Instrumentation and Control	15%	Motor control center (MCC), conduit and wire, programmable logic controller (PLC) and supervisory control and data acquisition (SCADA) equipment

Table 6.2
Engineering factors assumptions

Item	Percentage	Description
Contractor's Overhead and Profit	20%	Includes bonds, mobilization and demobilization, insurance, overhead and profit, and management reserves
Project Level Allowance	20%	Budget item to cover change orders due to unforeseen conditions
Engineering, Legal and Administrative	20%	Includes permits, legal fees, and engineering fees for design and construction.

DESIGN WATER QUALITY

The same design water quality used in the previous cost estimates (Blute et al., 2013b) was used in this cost update (Table 6.3) to provide a direct comparison with the prior estimates. The design concentrations were selected based on Glendale water quality and groundwater quality for several nearby Southern California cities. The ways in which the water quality variations might impact the costs are as follows:

- Cr(VI) concentrations: Raw water Cr(VI) concentration is not considered to affect RCF capital or O&M costs, as research shows a fixed ferrous sulfate dose of 3 mg/L (as iron) can effectively removal a range of Cr(VI) concentrations (from 15 µg/L to 100 µg/L). WBA resin life (part of O&M cost) is likely affected by raw water Cr(VI) concentrations, as the WBA results suggest (Figures 2.9 and 2.10). The assumed Cr(VI) concentration of 50 µg/L is a relatively conservative assumption.
- pH, alkalinity and calcium concentrations: These levels can affect the sizing and costs for pre- and post-pH adjustment systems of WBA. The average concentrations were input into the Tetra Tech RTW model to estimate the quantity of acid or CO₂ required to adjust the pH to 6.0 prior to WBA. Note that the sizing and costs of pH adjustment systems would vary for water systems with different pH, alkalinity, and calcium concentrations.

Table 6.3
Design raw water quality for WBA and RCF

Parameter (unit)	Design Value
Cr(VI) (µg/L)	50
pH (pH units)	7.3
Alkalinity (mg/L as CaCO ₃)	191
Calcium (mg/L as Ca)	79

WBA

Figure 6.2 shows the WBA process flow diagram, for which capital and O&M costs were developed. The process includes pre- and post-pH adjustment systems (CO₂ and aeration). Alternatively, acid and caustic soda can be used for pre- and post-pH adjustment. Aeration off-gas treatment was included at Glendale as its water contains VOCs which require off gas treatment using vapor phase GAC (VPGAC). However, for water sources without VOCs, aeration off-gas treatment is not needed. Thus, the capital and O&M costs in this chapter do not include aeration off gas treatment.

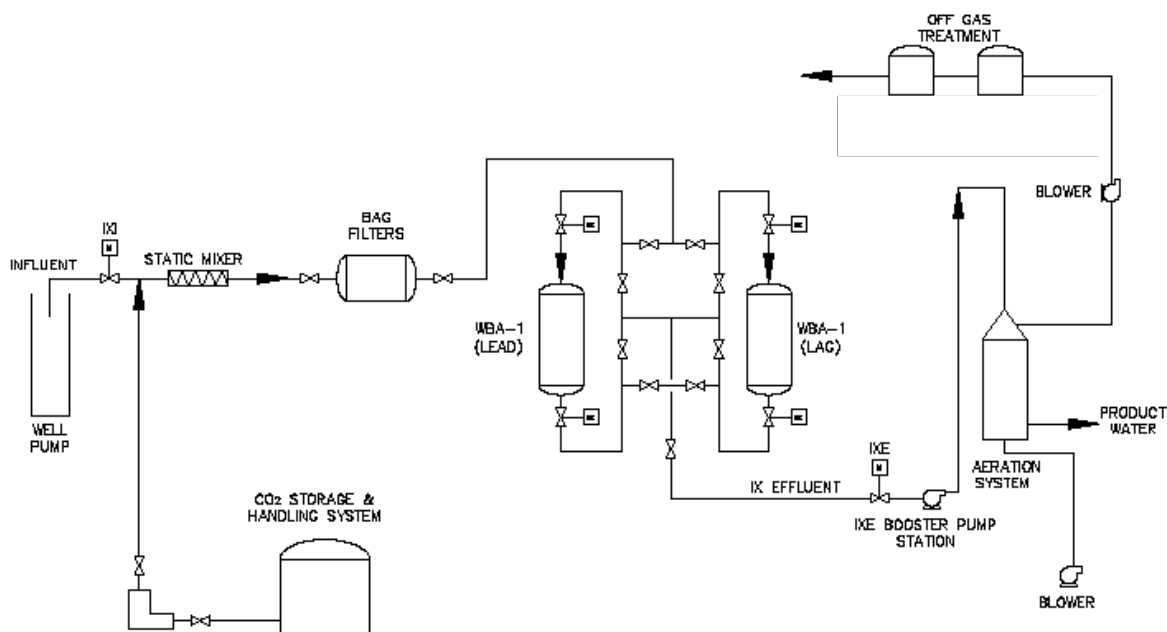

Source: Blute et al., 2013b.

Figure 6.2 WBA process flow diagram

Table 6.4 provides the design criteria for the WBA process on which the costs were estimated for each design flow. The same design criteria were applied for all three WBA resins. A lead-lag configuration was assumed, to maximize resin usage. In addition, this configuration is expected to reduce initial Cr(VI) leakage from ResinTech SIR-700 and Purolite S106, as observed in this study. The operating pH selected was 6.0, which was found to be effective at the Glendale demonstration-scale WBA and in the pilot testing in this study. ResinTech SIR-700 was pilot tested with a 2-minute EBCT. Purolite S106 was pilot tested with 3.75-minute EBCT, as recommended by the manufacturer. To provide a direct comparison, the vessels and resin bed volumes were sized to provide 3.74-minute EBCT for all three WBA resins, which was selected based on available standard vessels and the EBCTs tested for the resins. For ResinTech SIR-700 and Dow PWA7, this is more conservative than the tested EBCTs.

**Table 6.4
WBA design criteria**

WBA System Specifications	100 gpm	500 gpm	2,000 gpm
IX Vessel Configuration	1 lead/lag train	1 lead/lag train	2 lead/lag trains
Total Number of Vessels	2	2	4
Vessel Diameter (ft)	4	8	12
Volume of Resin per Vessel (cf)	50	250	500
Total Resin Volume for First Fill (cf)	100	500	2,000
Surface loading rate (gpm/sf)	8.0	9.9	8.8
HLR (gpm/cf)	2.0	2.0	2.0
EBCT per Vessel (minute)	3.74	3.74	3.74
Operating pH	6.0	6.0	6.0

Capital Cost

Capital cost development included the following assumptions:

- Excess capacity for redundancy was not included unless otherwise noted.
- A raw water pump was assumed to already exist with adequate pump pressure to convey the water flow through the WBA process. Booster pumps were assumed to be required to lift the water through an aeration tower for post-pH adjustment.
- Product water pumping and storage were not included.
- Land cost was not included.
- Equipment/operator building was not included.
- Pumps (i.e., chemical feed, waste discharge) included one standby unit to ensure uninterrupted service in the case of equipment maintenance.
- Carbon dioxide feed systems were sized based on the design water quality and RTW modeling of CO₂ dose needed to achieve pH 6.0.
- First fill resin costs were included in capital cost. The three WBA resins have different costs, which are incorporated in the capital costs for the first fill.
- Booster pumping to transfer the ion exchange effluent for post-pH adjustment was assumed to provide 15-ft of additional pressure at each design flow rate.
- Aeration was designed for CO₂ stripping to achieve a positive Langelier Saturation Index (LSI) and Calcium Carbonate Precipitation Potential (CCPP). The aluminum forced draft aerators include a blower and air distribution tray.

- Aeration off-gas was not included in the capital costs. However, aeration off-gas treatment (e.g. VPGAC) would be needed for water sources with high VOCs levels.
- WBA wastewater from resin change-out is assumed to be temporarily stored in a Baker tank and discharged to the sewer. For 100 and 500 gpm, one 21,000-gallon Baker tank is included. For 2,000 gpm, two 21,000-gallon Baker tanks are included.
- Concrete equipment pads for the CO₂ feed system, ion exchange system, and aeration tower were assumed to cost \$1,313 per cubic yard, reflecting adjusted cost to 2014 dollars.

The estimated capital costs for the three WBA resins are summarized in Table 6.5. Due to the different resin costs in the initial installment, the capital costs are slightly different for the three resins. Dow PWA7 has the highest cost (\$550/cf), and therefore the highest capital cost among the three resins. ResinTech SIR-700 and Purolite S106 have similar resin costs, and therefore, similar capital costs.

Table 6.5
WBA capital costs

Treatment System Size	Dow PWA7	ResinTech SIR-700	Purolite S106
100 gpm	\$1,456,000	\$1,450,000	\$1,432,000
500 gpm	\$2,890,000	\$2,763,000	\$2,730,000
2,000 gpm	\$6,287,000	\$5,779,000	\$5,615,000

Accuracy range is -30% to +50%.
In 2014 dollars.

O&M Cost

O&M costs were developed for WBA systems and included estimated annual costs for electricity, chemicals, resin replacement, spent resin and backwash wastewater disposal, other consumables (e.g., bag filters), labor, maintenance and spare parts, and analytical costs.

O&M costs for each system size were developed based on the following assumptions:

- A utilization rate of 100% of the design flow was assumed.
- No blending/ flow bypass was considered in the cost estimate.
- Electricity was assumed to cost \$0.105 per kilowatt hour (kWh) in 2014 dollars.
- CO₂ costs were based on the estimated dose required to achieve pH 6.0.
- Resin replacement costs were based on bed volumes and unit resin costs listed in Table 6.6.
- Baker tank rental cost was based on \$2,224 for one 21,000-gallon tank, including tank delivery and pickup.
- Backwash wastewater disposal costs were based on discharge to the sewer without treatment at a cost of \$3.15 per hundred cubic feet, plus a quarterly discharge fee of \$945, which is adjusted based on the costs for WBA wastewater disposal incurred at Glendale, in 2014 dollars.

- Labor costs were estimated based on \$105,000 per full time employee (FTE) per year (loaded), consistent with Glendale's costs. Staff time to operate and maintain a WBA system was assumed conservatively to require 0.5 FTE based on operator experience for the demonstration plant.
- Bag filters were assumed to require replacement every quarter based on vendor quotes.
- Maintenance costs were estimated to be 1% of total installed equipment costs.
- Analytical costs were developed based on a water quality monitoring schedule updated from the Glendale Phase III Demonstration study and averages of quotes from two laboratories.

The WBA resin costs and assumed operational life are compared in Table 6.6. The unit resin prices are based on budgetary quotes from manufacturers. The actual price is expected to vary for different water systems due to purchase size variations and other marketing factors. The resin cost for Dow PWA7 includes a preconditioning procedure to control formaldehyde leaching at startup. Spent resin disposal cost is based on the disposal cost for Dow PWA7 at Glendale and assumed to be the same for all three WBA resins, considering their characteristics are similar in regard to chromium and uranium. All three are likely to be classified as non-RCRA hazardous waste and TENORM with uranium levels above the 0.05% regulatory limit. The actual disposal cost may vary due to accessibility to landfills. Also, if an adsorbent material is used for dewatering, uranium levels may fall below the limit as in Glendale.

Bed volumes for ResinTech SIR-700 were estimated to be 260,000 BVs, the same as for Dow PWA7, based on similar pilot results and extrapolation from demonstration study results. Uncertainty exists even in the number of bed volumes treated at demonstration-scale in Glendale because a number of variables affect the resin life, such as fluctuations in Cr(VI) concentration and pH depression efficiency. Capacity to reach a treatment target of approximately 8 to 10 µg/L was estimated as shown in Table 6.6 for each resin. These values may in fact be conservative based on the most recent demonstration testing capacity observed at Glendale (360,000 BV to 5 µg/L in the lag effluent).

Bed volumes for Purolite S106 were estimated to be either 150,000 or 260,000 BV, since the testing only provided data to approximately 105,000 BV due to the greater bed depth required by the manufacturer for the testing. These two endpoints were selected to provide information on the impact of the endpoint on cost.

Table 6.6
WBA resin costs and operational life

Parameter	Dow PWA7	ResinTech SIR-700	Purolite S106
Cr(VI) Treatment Target for Lag Effluent	Approx. 8 to 10 µg/L	Approx. 8 to 10 µg/L	Approx. 8 to 10 µg/L
Fresh Resin Price	\$550/cf (with resin preconditioning and installation)	\$329/cf (with resin installation)	\$265/cf (plus \$10,000 per installation)
Spent Resin Disposal	\$342/cf	\$342/cf	\$342/cf
Resin Life in Lead Bed before Replacement	260,000 BVs*	260,000 BVs*	150,000 and 260,000 BVs

*260,000 BVs are considered to be conservative estimate to achieve 10 µg/L of Cr(VI) in lag effluent.

Annual O&M costs for the three WBA resins are summarized in Table 6.7. For 100 and 500 gpm, the O&M cost for ResinTech SIR-700 is the lowest, followed by Purolite S106 based on 260,000 BVs, Dow PWA7, and Purolite S106 based on 150,000 BVs. For 2,000 gpm, ResinTech SIR-700 and Purolite S106 based on 260,000 BVs are similar, followed by Dow PWA7 and Purolite S106 based on 150,000 BVs. The cost difference between the different resins is not large for this level of estimate. The estimated costs for Purolite S106 for the two scenarios suggest that O&M cost is more sensitive to resin costs for large systems. Fresh resin replacements account for 6% to 28% of the overall O&M cost, depending on the resin and system size. The primary drivers for O&M cost are analytical cost, labor, resin replacements, spent resin and wastewater disposal for 100 gpm. For 500 and 2,000 gpm, the primary drivers are resin replacement, spent resin and wastewater disposal, which are followed by electricity, analytical costs and labor.

Table 6.7
WBA annual O&M cost

Treatment System Size	Dow PWA7* (260,000 BVs)	ResinTech SIR-700 (260,000 BVs)	Purolite S106 (260,000 BVs)	Purolite S106 (150,000 BVs)
100 gpm	\$162,000	\$157,000	\$161,000	\$178,000
500 gpm	\$335,000	\$307,000	\$311,000	\$378,000
2,000 gpm	\$986,000	\$875,000	\$871,000	\$1,117,000

*PWA7 O&M cost was adjusted with a recent quote from Evoqua.
In 2014 dollars.

The 20-year NPV of O&M costs for the three WBA resins are summarized in Table 6.8. The same trends seen in the annual O&M costs are reflected in the 20-year NPV. The 20-year O&M cost was estimated in the \$15 to \$19 million range for WBA for all three resins at 2,000 gpm.

Table 6.8
WBA 20-year NPV of O&M cost

Treatment System Size	Dow PWA7* (260,000 BVs)	ResinTech SIR-700 (260,000 BVs)	Purolite S106 (260,000 BVs)	Purolite S106 (150,000 BVs)
100 gpm	\$2,700,000	\$2,600,000	\$2,700,000	\$ 3,000,000
500 gpm	\$5,600,000	\$5,100,000	\$5,200,000	\$ 6,300,000
2,000 gpm	\$17,000,000	\$15,000,000	\$15,000,000	\$ 19,000,000

*PWA7 O&M cost was adjusted with a recent quote from Evoqua.
20-year NPV O&M based on 2.5% inflation and a 4.5% discount rate in 2014 dollars.

Unit Treatment Cost

Unit treatment costs for WBA for all three resins are presented in Table 6.9. The unit cost for 100 gpm was estimated to range from \$1,655/AF to \$1,786/AF. For larger systems, the unit cost was estimated to be much lower, in the range of \$644 to \$729 for 500 gpm and \$404 to \$480 for 2,000 gpm, reflecting economies of scale.

Table 6.9
WBA unit treatment cost (\$/AF)

Treatment System Size	Dow PWA7* (260,000 BVs)	ResinTech SIR-700 (260,000 BVs)	Purolite S106 (260,000 BVs)	Purolite S106 (150,000 BVs)
100 gpm	\$1,698	\$1,655	\$1,681	\$1,786
500 gpm	\$691	\$644	\$646	\$729
2,000 gpm	\$455	\$409	\$404	\$480

RCF

Figure 6.3 illustrates the RCF process, for which the capital and O&M costs were developed for 100 gpm, 500 gpm and 2,000 gpm systems. The RCF process used for the cost estimates consisted of ferrous iron injection, 15-minutes reduction, followed by chlorination (no aeration) for excess ferrous iron oxidation, polymer addition, and granular media filtration. For this study, the costs were developed based on granular media filtration; microfiltration is another possible filtration approach.

The spent filter backwash water can be treated by settling/dewatering and then recycled back to the treatment process. The dewatered solids can be disposed to an appropriate landfill. Alternatively, the spent filter backwash water can be discharged directly to the sewer if the water quality and quantity meet the requirements for sewer discharge. Costs were developed for both scenarios (with and without recycle).

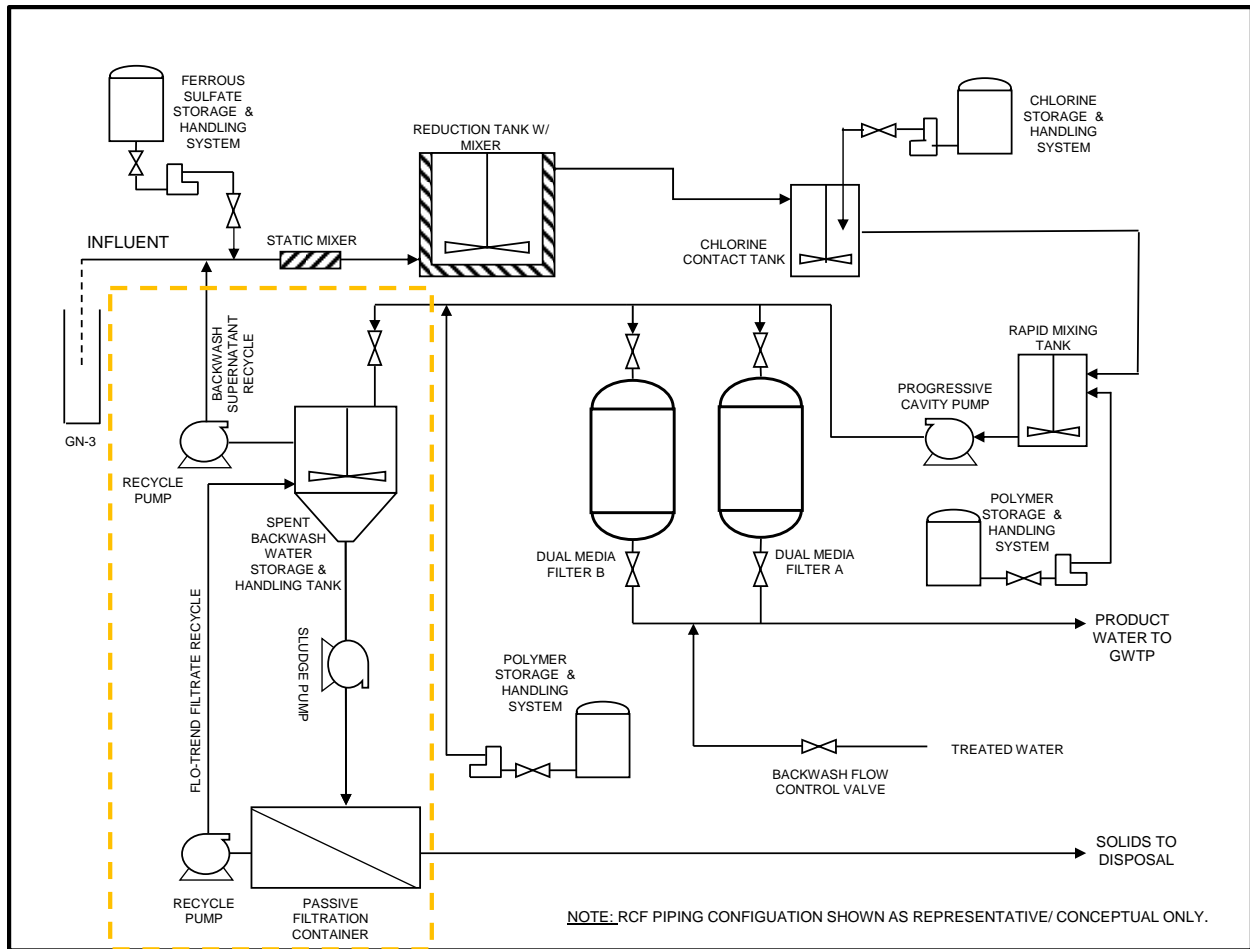

The highlighted area represents the optional spent filter backwash water treatment for recycle.

Figure 6.3 RCF process flow diagram

The design criteria used for estimating RCF costs are summarized in Table 6.10. The same water quality used for WBA (Table 6.3) was used for RCF. A fixed ferrous iron dose of 3 mg/L was assumed, based on the RCF results in this study. By comparison, previous costs published in the Glendale report (Blute et al., 2013b) were based on various ferrous doses for a range of raw water Cr(VI) concentrations. The filter run cycle was assumed to be 24 hours, as the RCF results in this study suggested that more frequent backwash may be important for Total Cr removal when a 3 mg/L of ferrous iron dose is used. By comparison, previous costs were based on 48 hours for ferrous doses from 1.25 to 2.5 mg/L and 72 hours for a ferrous dose below 1.25 mg/L, based on previous demonstration-scale test results with the lower ferrous iron dose. A chlorine dose of 1.3 mg/L with 5 minutes contact time was assumed to be effective for excess ferrous iron oxidation following reduction. The other design criteria remain the same as for the previous cost estimates.

Table 6.10
RCF design criteria

Item	Design Criteria
Ferrous Iron Dose (mg/L)	3*
Required Reaction Time (reduction) (minutes)	15
Chlorine Dose (mg/L)	1.3
Chlorine Contact Time (minutes)	5
Polymer Dose as Coagulant Aid (mg/L as active polymer)	0.1
Polymer Mixing Time in Tank (minutes)	5 [^]
Dual Media Filtration Rate (gpm/sf)	3
Filter Run Cycle (hours)	24
Filter Backwash Flow Rate (gpm/sf)	18
Filter Backwash Duration (minutes)	21
Polymer Dose as Solids Settling Aid to Spent Filter Backwash Water (mg/L as active polymer)	1

*3 mg/L is based on the RCF results in this study, which might be able to be decreased.

[^]Note that the rapid mix contact time is based on the system at Glendale and is likely excessive; the optimal time period for rapid mix should be tested before facility design and construction.

Capital Cost

Capital cost development included the following assumptions:

- Equipment was sized for plant capacity (100 gpm, 500 gpm and 2,000 gpm). Excess capacity for redundancy was not included unless otherwise noted.
- The raw water pump already exists and the pump pressure is sufficient to convey the water flow to the RCF process. The water flow is carried through the treatment train by gravity until being boosted by filter feed pumps. No intermediate pumping is provided.
- Pumps include a standby unit to ensure uninterrupted service in the case of equipment maintenance.
- Progressive cavity pumps are used in the design and cost estimates as the filter feed pumps for all RCF systems. A progressive cavity pump was tested in the demonstration study to minimize the break-up of iron and chromium floc. However, testing of other types of pumps may be warranted due to the high capital costs of progressive cavity pumps at high flow rates.
- Ferrous sulfate feed system was sized for a ferrous dose of 3 mg/L and a chemical storage period of 14 days.

- Reduction tank was sized to provide 15 minutes of contact time.
- Chlorine contact tank was sized to provide 5 minutes of contact time, which may be able to be decreased.
- Polymer mixing is achieved by a rapid mixing tank with a mechanical mixer. Other mixing methods (e.g. inline mixers) may also be used, if found to be effective.
- Filtration is achieved by pressurized granular media filters. Gravity filters and microfiltration could be used as alternatives (costs would differ).
- Filter backwash is supplied by stored treated water.
- For the RCF with recycle scenario, residuals treatment equipment was sized based on solids quantities estimated using mass balance, which was shown to be a conservative and reasonable approach for estimating residuals in the previous demonstration study (Blute et al. 2013b).
- For the RCF with recycle scenario, supernatant from thickeners is recycled back to the head of the RCF process. Filtrate from passive filtration containers (SludgeMate) is recycled back to the thickeners. Alternatively, discharge to the sewer or offsite disposal may be possible (resulting in disposal costs).
- For the RCF without recycle scenario, no residuals treatment equipment was included in the cost.
- Product water pumping and storage were not included.
- Land cost was not included.
- Equipment/operator building was not included.
- Concrete equipment pads were assumed to cost \$1,313 per cubic yard in 2014 dollars.

The estimated RCF capital costs for the two scenarios (with recycle and without recycle) are summarized in Table 6.11. For 100, 500 and 2,000 gpm systems, the estimated capital cost for RCF without recycle is \$1.9, \$3.2 and \$6.1 million, respectively. For RCF with recycle, higher capital costs are expected, \$2.1, \$3.9 and \$6.8 million, respectively.

Table 6.11
RCF capital cost

Treatment System Size	RCF without Recycle	RCF with Recycle
100 gpm	\$1,874,000	\$2,072,000
500 gpm	\$3,243,000	\$3,876,000
2,000 gpm	\$6,191,000	\$6,768,000

Accuracy range is -30% to +50%.
In 2014 dollars.

O&M Cost

Annual O&M costs were based on the following assumptions:

- A utilization rate of 100% of the design flow was assumed.
- The 5% ferrous sulfate solution cost is \$2.48 per gallon for orders in 55-gallon drums, in 2014 dollars.
- The sodium hypochlorite solution cost is \$4.36 per gallon in 2014 dollars.
- The polymer cost is \$24.37 per gallon in 2014 dollars.
- The electricity cost is \$0.105/kWh in 2014 dollars.
- Labor costs are estimated based on \$105,000 per FTE per year (loaded).
- Filter media is assumed to be replaced at a rate of 10% of the media volume in each filter every year, which reflects a usage life of 10 years.
- Maintenance costs are estimated as 1% of installed equipment costs.
- Spent filter backwash water accounts for 3% of the design flow rate, as determined in the previous demonstration study.
- Solid residuals quantities were estimated based mass balance of ferrous iron dose and chromium concentration in raw water. Dewatered solid residuals have a moisture content of 85%, which was observed for the dewatered solids during the previous demonstration study.
- Dewatered solid residuals are non-RCRA hazardous wastes in California.
- The landfill disposal cost for dewatered solid residuals is \$1.63 per pound, based on drum disposal in the previous demonstration study, which was adjusted to 2014 dollars. Bulk disposal in tons can result in cost savings.
- For the RCF with recycle scenario, all liquid waste is recycled back to the RCF process; no liquid waste discharge costs are included in the O&M costs.
- For the RCF without recycle scenario, all liquid waste is discharged to the sewer without treatment, assuming the water quality meets the sewer permit. The estimated discharge cost is \$3.15 per hundred cubic feet plus \$945 quarterly sewer fees.
- Analytical costs were developed based on a water quality monitoring schedule updated from previous demonstration study and averages of quotes from two laboratories.

The estimated RCF annual O&M costs are summarized in Table 6.12. For RCF without recycle, the estimated costs are \$0.22, \$0.38 and \$0.83 million for 100, 500 and 2,000 gpm, respectively. For RCF with recycle, the annual O&M costs are higher, which are \$0.27, \$0.58 and \$1.58 million, respectively. The difference in costs for the two scenarios is expected to increase with the treatment system size. The higher O&M costs for the recycle scenario reflect the residuals treatment and dewatered residuals disposal as non-RACA hazardous waste in California.

Table 6.12
RCF annual O&M cost

Treatment System Size	RCF without Recycle	RCF with Recycle
100 gpm	\$219,000	\$268,000
500 gpm	\$381,000	\$580,000
2,000 gpm	\$830,000	\$1,576,000

In 2014 dollars.

20-year NPV of RCF O&M costs are summarized in Table 6.13. For 500 and 2,000 gpm systems, the 20-year NPV for the recycle scenario are almost twice that of the one without recycle.

Table 6.13
RCF 20-year NPV of O&M cost

Treatment System Size	RCF without Recycle	RCF with Recycle
100 gpm	\$3,700,000	\$4,500,000
500 gpm	\$6,000,000	\$10,000,000
2,000 gpm	\$14,000,000	\$26,000,000

In 2014 dollars.

Unit Treatment Cost

The estimated unit treatment costs for RCF with and without recycle are summarized in Table 6.14. For 100 gpm, the unit cost is high compared to Metropolitan Water District water (MWD water) for which the full service treated volumetric cost in 2014 was \$890/AF (Tier 1) and \$1,032/AF (Tier 2). For 500 gpm, the RCF cost is comparable to MWD water. For 2,000 gpm, the RCF cost is lower than MWD water, especially for the process without recycle.

Table 6.14
RCF unit treatment cost (\$/AF)

Treatment System Size	RCF without Recycle	RCF with Recycle
100 gpm	\$2,251	\$2,649
500 gpm	\$782	\$1,089
2,000 gpm	\$405	\$650

In 2014 dollars.

REFERENCES

- Blute, N., Wu, X., Cron, C., Fong, L., Froelich, D., Abueg, R., 2013a. *Microfiltration in the RCF Process for Hexavalent Chromium Removal from Drinking Water*. Submitted for publication. Water Research Foundation, Denver.
- Blute, N., Wu, X., Porter, K., Imamura, G., and McGuire, M., 2013b. *Hexavalent Chromium Removal Research Project Report*. California Department of Public Health, Sacramento, Calif. www.glendalewaterandpower.com/pdf/Chromium6Report2013.pdf (accessed March 2013).
- Eaton, A. 2011. Chromium+6 Deja Vu All Over Again - Analytical issues and occurrence. *MWD Cr(VI) Summit*, August 2011.
- Kawamura, S. 2000. *Integrated Design and Operations of Water Treatment Facilities*. Wiley.
- Lang, L.S., Giron, J.J., Hansen, A.T., Trussell, R.R., and Hodges, W.E., 1993. Investigating Filter Performance as a Function of the Ratio of Filter Size to Media Size. *Jour. AWWA*, 85(10):122-130.
- McLellan, N., McLeod, J., and Emelko, M. 2011. Wall Effects during Filtration Investigations: Reconsideration of Column-Diameter to Collector-Diameter Ratio Recommendations. *Proceedings of the AWWA Water Quality and Technology Conference*. Phoenix, AZ.
- Najm, I., Brown, N.P., Seo, E., Gallagher, B., Gramith, K., Blute, N., Wu, X., Yoo, M., Liang, S., Maceiko, S., Kader, S., Lowery, J. 2014. *Impact of Water Quality on Hexavalent Chromium Removal Efficiency and Cost*. Water Research Foundation, Denver.
- The Dow Chemical Company. 2001. Dow Tech Facts: Lab Guide. Column Separations using Resins and Adsorbents. http://msdssearch.dow.com/PublishedLiteratureDOWCOM/dh_015a/0901b8038015ac4e.pdf?filepath=liquidseps/pdfs/noreg/016-00003.pdf&fromPage=GetDoc

ABBREVIATIONS

AACE	Association for the Advancement of Cost Engineering
AF	acre foot
ANSI	American National Standards Institute
ASTM	American Society of Testing and Materials
Bacti	Total Coliform, E. Coli, and Heterotrophic Plate Counts
BV	bed volume
BVs	bed volumes
⁰ C	degrees Celsius
CaCO ₃	Calcium Carbonate
CCPP	Calcium Carbonate Precipitation Potential
cf	cubic foot
CFU/mL	colony-forming units per milliliter
Cl ₂	Chlorine
CO ₂	carbon dioxide
Cr	Chromium
Cr(III)	trivalent chromium
Cr(VI)	hexavalent chromium
CWET	California Waste Extraction Test
DDW	Division of Drinking Water
DWR	Department of Water Resources
EBCT	empty bed contact time
ENR	Engineering News-Record
Fe	iron
ft	feet
FTE	full time employee
GAC	granular activated carbon
gal	gallons
gpm/cf	gallons per minute per cubic feet
gpm/sf	gallons per minute per square feet
HCl	hydrogen chloride
HLR	hydraulic loading rate
HPC	Heterotrophic Plate Count
in	inches
kWh	kilowatt hour

LLC	limited liability company
LLRW	Low-Level Radioactive Waste
LSI	Langelier Saturation Index
MCC	motor control center
MCL	maximum contaminant level
MEK	methyl ethyl ketone
mg/kg	milligrams per kilograms
mg/L	milligrams per liter
MIBK	methyl isobutyl ketone
min	minutes
mL/min	milliliters per minute
MPN/100mL	most probable number per 100 milliliters
MWD	Metropolitan Water District
N	Nitrogen
N/A	not applicable
NAH	North American Höganäs
NDBA	N-Nitrosodibutylamine
ng/L	nanograms per liter
NH ₃ -N	ammonia as nitrogen
NMOR	N-nitrosomorpholine
NO ₃ -N	nitrate as nitrogen
NPIP	N-Nitrosopiperidine
NPV	net present value
NSF	National Science Foundation
NTP	National Toxicology Program
NTU	Nephelometric Turbidity Units
O&M	operating and maintenance
PAC	Project Advisory Committee
PCE	Tetrachloroethylene
pCi/L	picocuries per liter
PHG	Public Health Goal
PLC	programmable logic controller
PO ₄	phosphate
ppb	parts per billion
RCF	reduction coagulation filtration
RCRA	Resource Conservation and Recovery Act
SBA	strong base anion exchange
SCADA	supervisory control and data acquisition
sf	square foot

SiO ₂	silicone dioxide
SM	Standard Methods
SMI	sulfur modified iron
SO ₄	Sulfate
STLC	Soluble Threshold Limit Concentration
SVOCs	semi-volatile organic compounds
TCLP	Toxicity Characteristic Leaching Procedure
TENORM	Technologically Enhanced Naturally Occurring Radioactive Material
THM	Trihalomethanes
TICs	tentatively identified compounds
TOC	total organic carbon
TSS	total suspended solids
TTLC	Total Threshold Limit Concentrations
UCMR3	Unregulated Contaminant Monitoring Rule 3
µg/L	micrograms per liter
uS/cm	Microsiemens Per Centimeter
USEPA	United States Environmental Protection Agency
VOCs	volatile organic compounds
VPGAC	vapor phase GAC
WBA	weak base anion exchange

APPENDIX A: DOW PWA7 PRECONDITIONING STUDY

Evaluation of Resin Preconditioning and Operational Strategies to Minimize Leaching of Chemicals from Weak-Base Anion Exchange Resins Used in Hexavalent Chromium Treatment

INTRODUCTION

Weak-base anion exchange (WBA) has been shown to be an effective treatment technology for removing hexavalent chromium, Cr(VI), from groundwater. WBA resin is advantageous in its very high capacity (more than 170,000 bed volumes treated, translating to over 1 year of operational life for each bed in a lead/lag configuration). Operational requirements are minimal for this technology compared with other leading technologies, with the exception of pre-conditioning needs.

Until this study, Dow PWA7 was the only National Sanitation Foundation (NSF) certified WBA resin for use in potable drinking water applications shown to have this high capacity. In two years of full-scale (425 gpm) at the City of Glendale California, three Dow PWA7 resin changeout procedures were conducted – the initial fill of two vessels, and two subsequent replacements of lead beds when the lag bed reached an effluent chromium concentration of 5 µg/L.

An important component of WBA demonstration-scale testing was to identify and, if possible, mitigate unintended consequences of treatment. One of the unintended consequences observed for Dow PWA7 WBA resin was formaldehyde leaching above the California notification level of 100 µg/L. Resin preconditioning was performed to minimize formaldehyde leaching for previous resin changeouts. Formaldehyde concentrations in treated water were found to be below 100 µg/L after preconditioning at the Evoqua Facility; however, formaldehyde increased to above 100 µg/L once loaded into the vessel at the Glendale site. Subsequently, formaldehyde gradually decreased over time with forward flushing, requiring up to one month of flushing the water to waste before concentrations were less than 100 µg/L formaldehyde. The development and testing of a rigorous procedure to pre-treat the PWA7 resin was viewed as necessary for utilities that will not be able to divert flow after startup, and for those wishing to minimize water losses.

OBJECTIVES

This study consisted of two parts. The first part evaluated Dow's preconditioning procedure that was updated in 2013. The purpose of this part was to evaluate the effectiveness of the 2013 resin preconditioning procedure for formaldehyde leaching, to monitor formaldehyde levels under different holding conditions, and to evaluate formaldehyde leaching once resin was transported and installed to a vessel onsite. In addition, the potential for release (re-equilibration) of constituents accumulated on the resin after periods of non-operation was also evaluated, including formaldehyde, nitrate and chromium. This mechanism has been observed for anions like nitrate on granular activated carbon and can result in a higher effluent concentrations compared with influent concentrations. The first part was conducted in November and December 2013.

The second part was a follow-up study, which evaluated further optimized preconditioning procedure (referred as 2014 preconditioning procedure) based on the findings of the first part. An observation during the first part was that an extended hold time of 8 hours in low pH water may

more rapidly flush out formaldehyde from the installed resin. The second part of the study was conducted with the approach of holding a preconditioned resin (using the 2014 preconditioning procedure) in low pH water for more than 8 hours. The second part was performed in May 2014.

APPROACH

The first part of the study is described in Tasks 1 to 3, and the second part is described in Tasks 4 to 5.

Task 1 –Testing of Constituent Leaching after Pre-Conditioning using the 2013 Preconditioning Procedure

A batch of fresh Dow PWA7 resin was pre-conditioned at the Evoqua Facility with the procedure provided by Dow that they reported to be effective in laboratory testing. The preconditioning procedures are proprietary. Resin preconditioning was conducted by Evoqua and supervised by Dow staff onsite. Formaldehyde field tests and lab samples collection were performed by Hazen and Sawyer for third-party verification. A total of 14 cubic feet (cf) of resin were pre-conditioned in a 32-cf vessel on November 12, 2013 (Figure A.1). After 8 hours of preconditioning (from 11 am to 7 pm), formaldehyde was found to be 233 $\mu\text{g/L}$ using field measurement methods. The resin was flushed overnight with chlorine-free tap water. Formaldehyde was below 100 $\mu\text{g/L}$ (68 $\mu\text{g/L}$ and 63 $\mu\text{g/L}$) at 8 am on November 13. Laboratory samples were then collected for formaldehyde and bacti at 9:15 am. The resin was continually flushed with chlorine-free tap water while waiting on lab results until it was transported to Glendale.



Figure A.1 Resin preconditioning vessel

The question of whether the transportation time increases the amount of formaldehyde leaching from resin was evaluated in this task. Six subsamples of the pre-conditioned resin were slurried into small columns (Figure A.2) and held saturated or dewatered for 2, 4 and 8 hours at the Evoqua Facility (Table A.1). Afterwards, the resin was flushed using chlorine-free tap water and formaldehyde was tested at 20 and 40 bed volumes (BVs) of throughput. This column test was operated by Evoqua, with formaldehyde testing performed by Hazen and Sawyer.

Table A.1
Resin holding test after pre-conditioning at Evoqua Facility

Resin Condition	Formaldehyde Test	
	20 BVs	40 BVs
Saturated		
2 hours	X	X
4 hours	X	X
8 hours	X	X
Dewatered		
2 hours	X	X
4 hours	X	X
8 hours	X	X

X – Conditions for which samples were collected



Figure A.2 Photograph of small columns used for resin holding test

Task 2 –Testing of Constituent Leaching at Glendale after Pre-Conditioning using Dow 2013 Preconditioning Procedure

In this task, formaldehyde leaching was monitored for over one month once resin was installed into a vessel at the Glendale GS-3 site. The resin was treated as intended in full-scale application. At the Evoqua Facility, resin effluent formaldehyde was confirmed to be below 100 µg/L (23 µg/L) on November 14 at 8:40 am. The resin was flushed while bacti results were pending. After the bacti results were confirmed negative, the preconditioned resin was dewatered, held in the 32-cf vessel and transported to Glendale at 12 pm. This procedure simulated the typical procedures for resin transport, except that the resin would be transferred into a mobile vessel on a truck first.

At the Glendale site, 12 cf of the preconditioned resin was slurried from the 32-cf vessel to a Super 12 vessel (12-cf capacity) at 1:30 pm. The Super 12 was then backwashed for 3 BVs and forward flushed for a total of 40 BVs, which simulates the procedures for full-scale resin installation. Formaldehyde was monitored throughout the process. After forward flushing, the Super 12 was continuously operated with a 30-gpm flow (translating into 2.5 gpm/cf, which is the same hydraulic loading rate as full scale). The GS-3 well water with carbon dioxide (pH 6.0) was used for resin backwash, forward flushing and normal operations of the Super 12. The Super 12 effluent was discharged back to the GS-3 well casing with approval of DDW. Formaldehyde was monitored three times per week for one month.

An additional column test was performed to evaluate the effect of water pH on formaldehyde leaching from resin after installation. The Glendale GS-3 raw water was used for this testing, including one sidestream at ambient pH (approximately 7.2) and another sidestream at pH 6.0 with carbon dioxide. The preconditioned resins tested in the small columns at Evoqua were composited and two subsamples were used in the column testing at Glendale. Two 2.5-inch diameter columns were filled with the same amount of resin samples. Once installed, the two resins were first rinsed using the raw water at ambient pH to quantify initial formaldehyde concentrations and also to verify the two resin samples did not release significantly different formaldehyde levels. Both resins were then backwashed for 3 BVs, followed by forward flush for 40 BVs, which simulated full-scale resin installation. For backwash and forward flush, one column was exposed to raw water at ambient pH, while the other column was operated with raw water at pH 6.0. Formaldehyde was monitored through the process.

Task 3 – Testing of Constituent Leaching during WBA Resin Operations

In this task, Dow PWA7 resin in the Super 12 vessel and two additional resins (Purolite S106 and ResinTech SIR-700), were subjected to temporary shutdown/restart conditions to evaluate the potential for leaching of constituents of concern known to either be released from the resin (e.g., formaldehyde) or accumulated on the resin to some degree (e.g., nitrate).

To represent worst case conditions, resin operation was suspended for 72 hours, then brought back online with samples collected during the first hour after operations resumed. The selected frequency, shown as follows, was based on findings of nitrate leaching from GAC showing peaking after 48 hours or longer of shutdown, which peaked within one hour and dissipated within two hours.

- Formaldehyde – field testing of concentrations at 15 minutes, 30 minutes, and 60 minutes after restart.
- Nitrate – lab testing of concentrations at 15 minutes, 30 minutes, and 60 minutes after restart.
- Chromium – total and hexavalent - lab testing of concentrations at 15 minutes, 30 minutes, and 60 minutes after restart.

In addition to the worst case conditions, a more typical operation with a 4 hour shutdown was tested with respect to Cr(VI) and total chromium, sampled 15, 30 and 60 minutes after restart. For both shutdown conditions, background samples for the constituents interested were collected before the shutdowns.

Task 4 –Testing of Constituent Leaching after Pre-Conditioning using the Dow 2014 Preconditioning Procedure

Based on the findings from Tasks 1 to 3, Dow further revised the 2013 preconditioning procedure. The revised procedure is referred to as the 2014 preconditioning procedure in this report. A batch of fresh PWA7 resin was pre-conditioned at the Evoqua Facility with this new 2014 procedure. Resin preconditioning was conducted by Evoqua and supervised by Dow staff onsite. Formaldehyde field tests and lab samples collection were performed by Hazen and Sawyer.

A total of 14 cubic feet (cf) of resin were pre-conditioned in the same 32-cf vessel as in Task 1 during May 6 and 7, 2014. The preconditioning procedure was complete on May 7th and a formaldehyde sample was collected for lab analysis. The preconditioned resin was held saturated overnight on May 7th and flushed on May 8th. A bacti sample was collected on May 8th. Following flushing, formaldehyde was tested again in the field.

Task 5 –Testing of Constituent Leaching at Glendale after Pre-Conditioning using the Dow 2014 Preconditioning Procedure

The preconditioned resin in Task 4 was transported to Glendale in the same vessel in which it was preconditioned on May 8th. At the Glendale GS-3 site, 12 cf of the resin was transferred to a Super 12 vessel and held saturated in pH 6 water (GS-3 water with CO₂) overnight without any flushing. The Super 12 vessel used in Task 2 was found to have deteriorated lining inside the vessel. Thus, a different Super 12 vessel was used in Task 5, which had the same configuration as the previous Super 12 vessel. On the next day, the resin was first backwash for 3 BVs and then forward flushed at 30 gpm. Formaldehyde was monitored at the end of backwash and approximately every 10 bed volumes of forward flushing for 80 bed volumes. Formaldehyde was then monitored three times a week for two weeks.

RESULTS

Study results are summarized for the first three tasks and the final two tasks.

Task 1 –Testing of Constituent Leaching after Pre-Conditioning using the Dow 2013 Preconditioning Procedure

Formaldehyde concentrations during and after the pre-conditioning process at the Evoqua Facility are summarized in Table A.2. After the preconditioning was complete, the formaldehyde concentration was 68 µg/L in resin effluent, which further decreased to 23 µg/L the next morning with continuous flushing. The results suggested that the preconditioning procedure was effective at reducing formaldehyde to below 100 µg/L at the Evoqua Facility.

**Table A.2
Formaldehyde in resin effluent during and after pre-conditioning at the Evoqua Facility using the Dow 2013 preconditioning procedure**

Sampling Date/Time	Conditions	Formaldehyde
11/12/13 7:00 pm	Chemical preconditioning completed, still forward flushing	233 µg/L
11/13/13 8:00 am and 9:15 am	Preconditioning complete, still forward flushing	68 µg/L (Repeat sample - 66 µg/L) (Lab sample – 66 µg/L)
11/14/13 8:40 am	Flushing while waiting on lab results	23 µg/L

Formaldehyde results for the resin holding test at the Evoqua Facility are summarized in Table A.3 and Figure A.3. Note the resin consisted of subsamples from the preconditioned batch, for which formaldehyde leaching was confirmed below 100 µg/L (68 µg/L on November 13). Under saturated conditions, higher formaldehyde concentrations were observed for shorter holding times. For example, formaldehyde leached from saturated resin held stagnant for 2 hours was up to 2,760 µg/L after flushing for 20 BVs and 2,510 µg/L after flushing for 40 BVs. For resin held saturated for 8 hours, formaldehyde was decreased to 70 µg/L at 20 BVs and 56 µg/L at 40 BVs, which are below the California notification level of 100 µg/L.

The reason for much lower formaldehyde levels with longer holding times was not clear. We hypothesize that longer holding times may result in more formaldehyde released from the resin in the first flush, effectively flushing out more formaldehyde so that less is released at 20 and 40 BVs. This testing did not measure the first flush concentrations, so this hypothesis could not be confirmed in this test.

Under dewatered stagnant conditions, the same trends were observed with decreasing formaldehyde levels from higher holding times. However, the formaldehyde concentration was much lower when the resins were subject to dewatered conditions compared with saturated conditions. For example, for 2 hours of holding time, the formaldehyde concentration was 110 µg/L at 20 BVs under dewatered conditions, compared to 2,760 µg/L under saturated conditions. In general, formaldehyde levels slightly decreased with flushing, or remained similar (e.g., 2 hour hold time).

These test results suggest that formaldehyde leaching from the resin is higher when the resin is stored under saturated conditions, especially for short holding times (e.g., 2 hours). If the resins are subject to saturated conditions after preconditioning, longer holding times of 8 hours or

longer are preferred to limit excessive formaldehyde leaching after the initial backwashing period. Dewatered conditions with longer holding times resulted in the lowest levels of formaldehyde particularly if the resin was held for 4 hours or more. For both saturated and dewatered conditions, flushing is expected to be necessary to rinse formaldehyde accumulated during the holding times.

Table A.3
Resin holding test results after pre-conditioning at the Evoqua Facility
using the Dow 2013 preconditioning procedure

Resin Condition	Formaldehyde Concentrations (µg/L)	
	20 BVs	40 BVs
Saturated		
2 hours	2,760 (Repeat sample = 2,520 µg/L)	2,510
4 hours	370 (Repeat sample = 380 µg/L)	271
8 hours	70	56
Dewatered		
2 hours	110	120
4 hours	37	34
8 hours	22	13

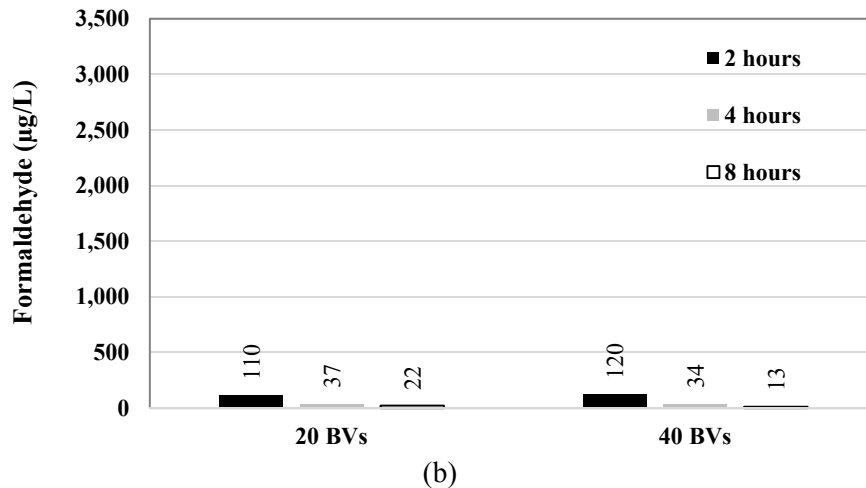
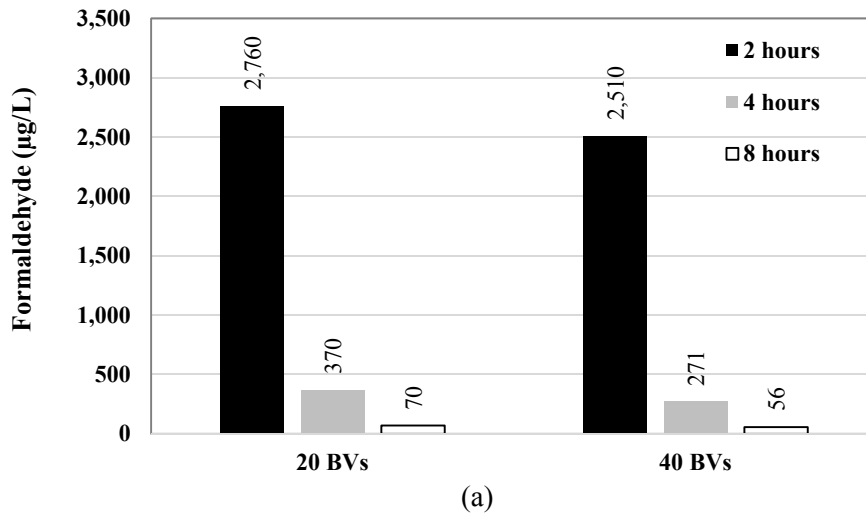

Figure A.3 Formaldehyde leaching from preconditioned resins using the Dow 2013 preconditioning procedure under (a) saturated conditions and (b) dewatered conditions at varying holding times

Task 2 –Testing of Constituent Leaching after Pre-Conditioning at Glendale using the Dow 2013 Preconditioning Procedure

Table A.4 summarizes formaldehyde results during resin installation at the Glendale GS-3 site. Formaldehyde was 108 µg/L in resin effluent after backwash for 3 BVs, which was higher than 23 µg/L tested at the Evoqua Facility. It is likely the resin transportation and slurry process contributed to some of the formaldehyde increase. The time span between the dewatering step

and the transfer of resin into the Super 12 vessel was less than two hours, representing the dewatered, 2 hour holding time condition where an increase in formaldehyde leaching of similar magnitude was observed in Task 1. After backwash, formaldehyde increased to 290 µg/L at 20 BVs forward flushing and 370 µg/L at 40 BVs.

Table A.4
Formaldehyde results during resin installation at Glendale
using the Dow 2013 preconditioning procedure

Procedure	Sampling Event	Formaldehyde Result (µg/L)	
		Field	Lab
Backwash (BW)	BW 3 BVs	108	Not tested
Forward Flush (FW Flush)	FW Flush 20 BVs	376	290
	FW Flush 40 BVs	400	370
Glendale GS-3 Raw Water*	Raw water without CO ₂	65	Not tested
	Raw water with CO ₂ (Super 12 Influent)	23	14

*Raw water samples were collected when the resin was forward flush for approximately 20 BVs.

Figure A.4 shows formaldehyde results during the first month after resin installation at Glendale. Influent (groundwater with CO₂) contained formaldehyde, which decreased from 7.8 µg/L to non-detect (< 5 µg/L) over time. Formaldehyde was likely introduced into the influent groundwater source as the discharge from the Super 12 vessel was recirculated back into the well via a well casing. The formaldehyde levels in the effluent declined over time, dropping down from an initial concentration of 433 µg/L to below 100 µg/L in two weeks of continuous operation, decreasing further to 19 µg/L by the end of the first month. Lab results confirms the same trend.

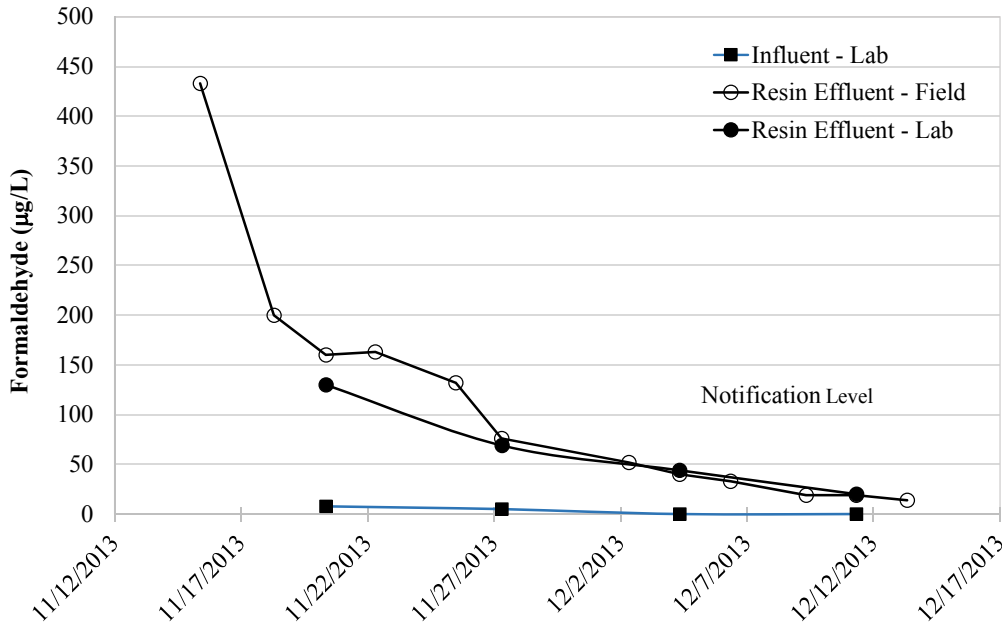

* Resin installed on 11/14/13

Note: Influent formaldehyde field results are not included in the figure (ranged from -26 to 183 µg/L), considering the field test method might be interfered by CO₂ bubbles released from the water sample.

Figure A.4 Formaldehyde leaching from preconditioned resins at Glendale using the Dow 2013 preconditioning procedure after installation

Figure A.5 shows the formaldehyde results of the additional column testing at Glendale, which suggests that a reduced pH has an impact on formaldehyde leaching. Both resins were first flushed with raw water at ambient pH 7.2. Formaldehyde concentrations were similar for the two resins in this “Initial Rinse” sample. For the resin exposed to ambient pH water, formaldehyde levels generally dropped with backwash and forward flush over time. After forward flush for 20 BVs, formaldehyde was below 100 µg/L for the resin run at ambient pH. Resin exposed to pH 6.0 water leached formaldehyde at higher concentrations compared with the ambient water. Formaldehyde was even shown to increase with backwash and forward flush, reaching 586 µg/L at 40 BVs. These results suggest that a reduced pH of 6.0 increased formaldehyde leaching, compared to ambient pH 7.2. This may explain the significant increases in formaldehyde levels once resin installed in vessels at Glendale in previous replacements and this study, as raw water with carbon dioxide was used for resin backwash and forward flush. For resin preconditioning at the Evoqua Facility, chlorine-free tap water with a typical pH above 8 was used. The change to lower water pH at Glendale may explain the additional formaldehyde leaching from the resin observed once installed.

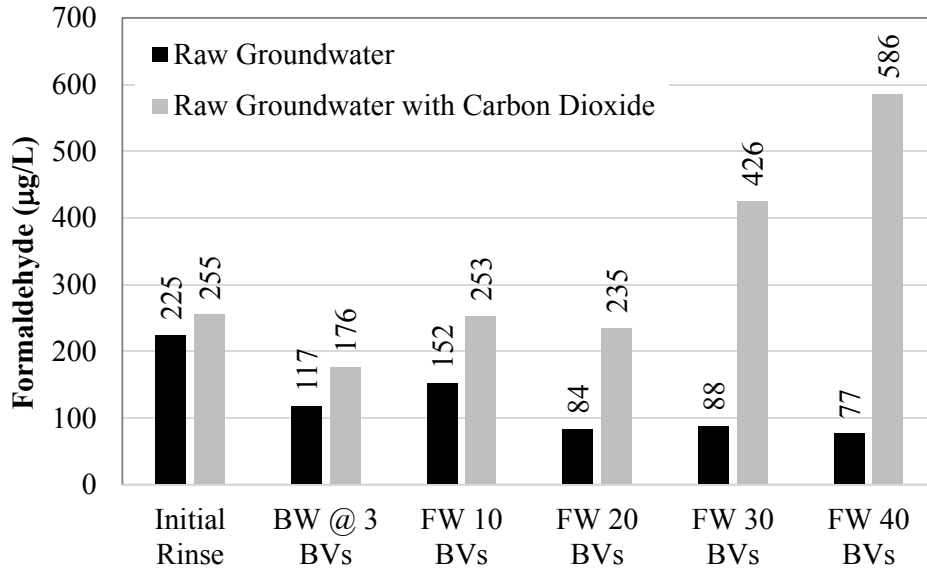

Figure A.5 Formaldehyde leaching from preconditioned resin using the Dow 2013 preconditioning procedure when exposed to raw groundwater at pH 7.2 vs pH 6.0

Task 3 – Testing of Constituent Leaching During WBA Operations

During the 72-hour shutdown tests, formaldehyde, nitrate, Cr(VI), and total chromium were monitored pre-shutdown, 15, 30 and 60 minutes after resuming normal operation. Figure A.6 shows formaldehyde concentrations in the resins effluents from Dow PWA7, Purolite S106 and ResinTech SIR-700. No significant increases in formaldehyde leaching were noted for the three resins after shutdown and restart. Dow PWA7 released more formaldehyde compared to the other two resins, which is reasonable as Purolite S106 and ResinTech SIR-700 do not have a formaldehyde backbone structure like Dow PWA7.

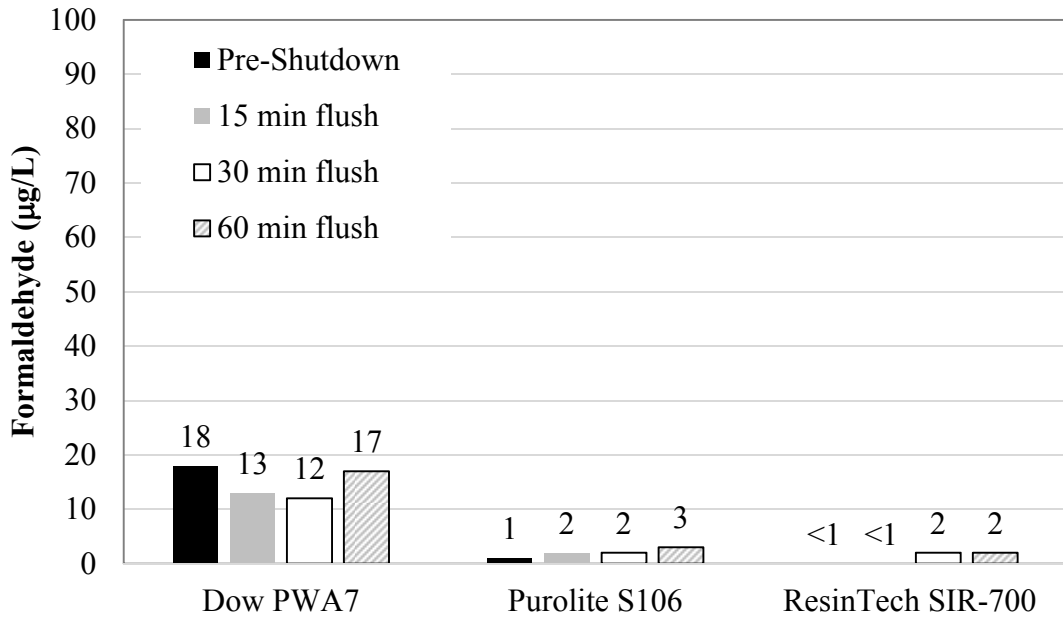

Figure A.6 Formaldehyde leaching after 72-hour shutdown

Figure A.7 shows nitrate concentrations in the resins effluents from Dow PWA7, Purolite S106 and ResinTech SIR-700. No significant increases in nitrate concentrations were noted for the three resins after shutdown and restart. The three resins had similar nitrate concentrations in the effluents after restart.

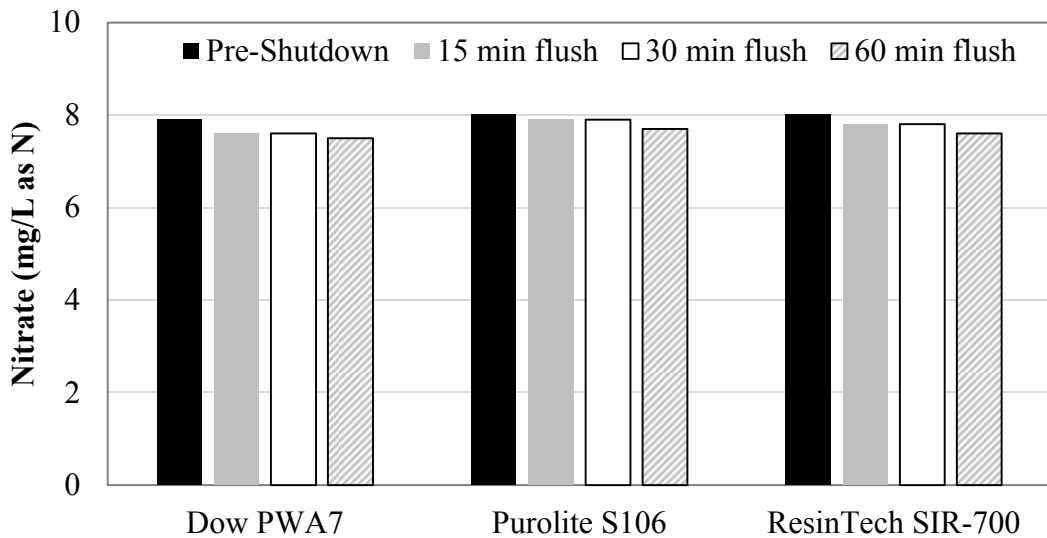

Figure A.7 Nitrate leaching after 72-hour shutdown

Figures A.8 and A.9 show Cr(VI) and Total Cr concentrations in the resins effluents from Dow PWA7, Purolite S106 and ResinTech SIR-700. Cr(VI) concentrations were generally below 1 µg/L, except for Dow PWA7 before shutdown. Low Total Cr levels were detected before and after shutdown for all three resins, with the highest level (2.5 µg/L) for Purolite S106 after restart. Considering the low Cr(VI) levels, Total Cr mostly consists of Cr(III). The results indicate that low levels of Cr(III) can leach from the Purolite S106 and to a lesser extent the ResinTech SIR-700 after shutdown and restart.

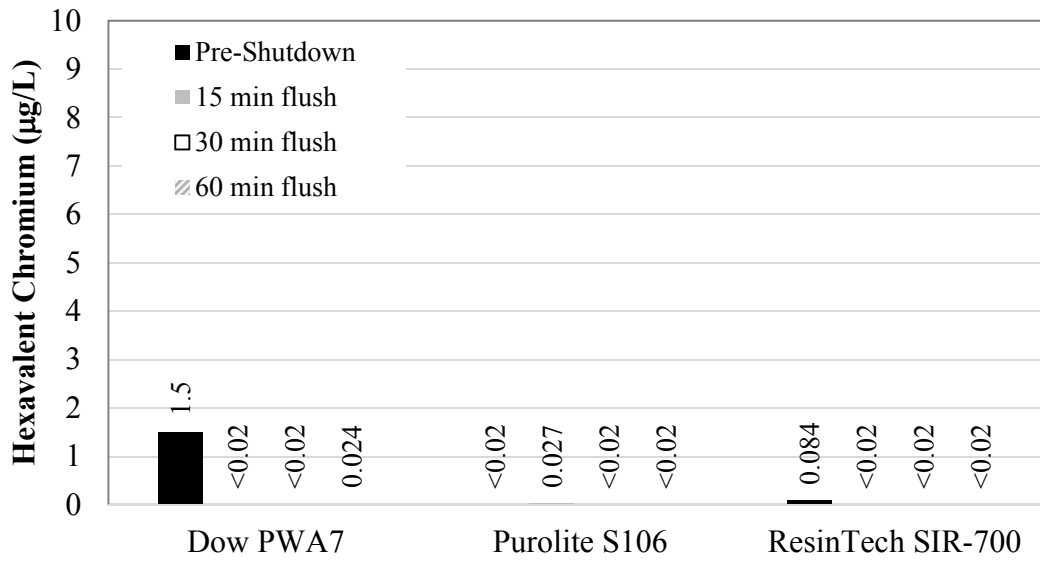

Figure A.8 Hexavalent chromium leaching after 72-hour shutdown

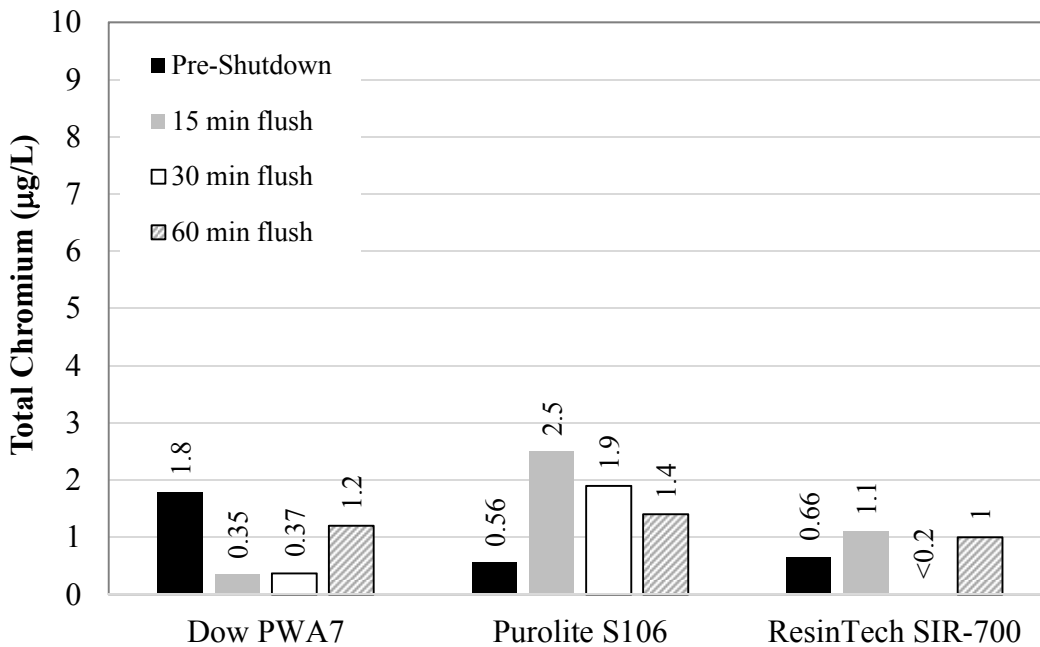

Figure A.9 Total chromium leaching after 72-hour shutdown

During the 4-hour shutdown tests, Cr(VI) and Total Cr were monitored pre-shutdown, 15, 30 and 60 minutes after resuming normal operation. Figures A.10 and A.11 show Cr(VI) and Total Cr concentrations in the resins effluents from Dow PWA7, Purolite S106 and ResinTech SIR-700. No significant Cr(VI) leaching was detected ($< 1 \mu\text{g/L}$) in all resin effluents before and after 4-hour shutdown. Total Cr concentrations were all below 1 $\mu\text{g/L}$.

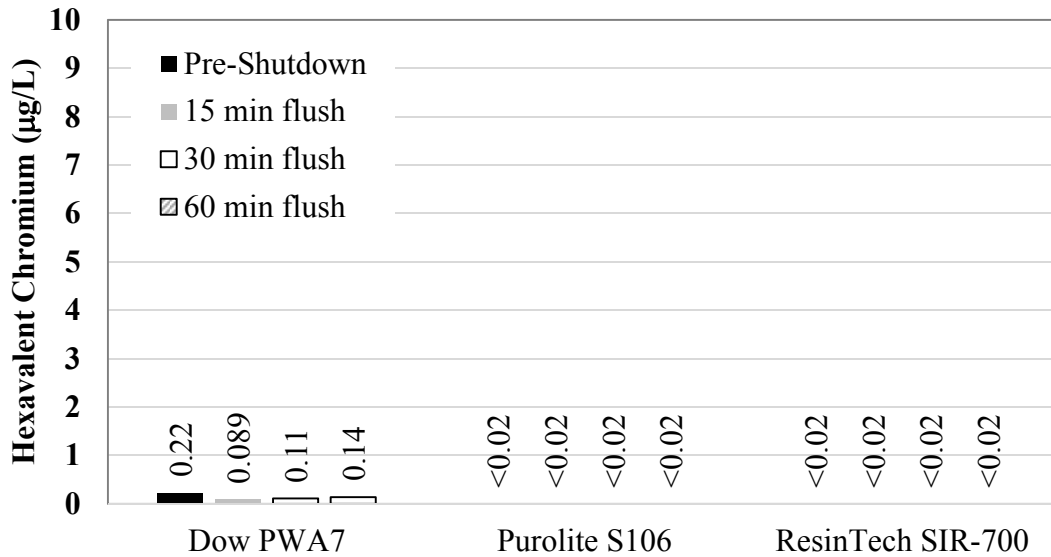

Figure A.10 Hexavalent chromium leaching after 4-hour shutdown

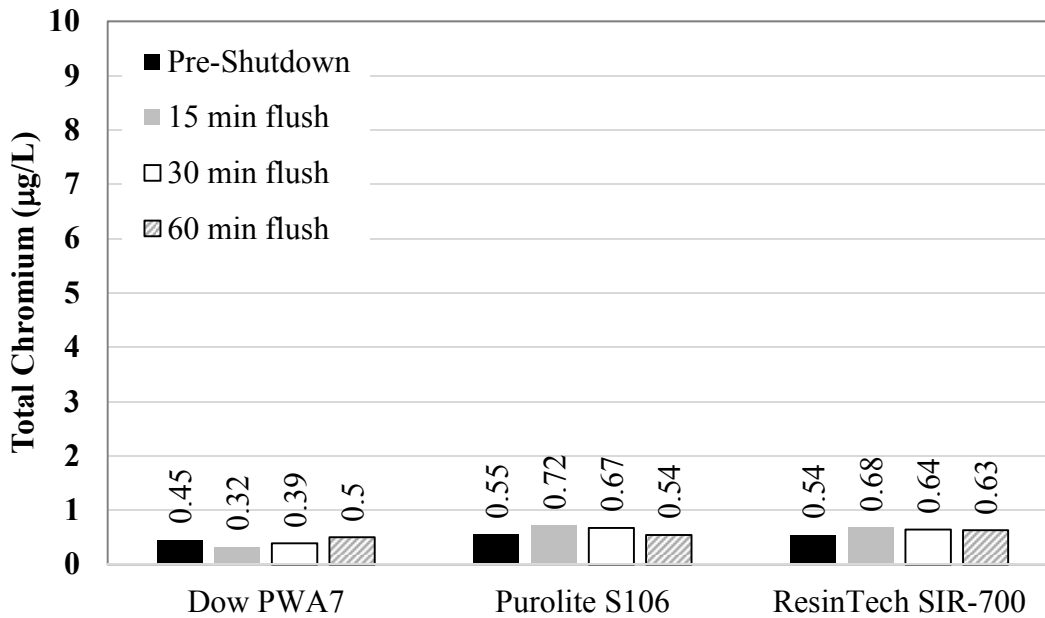

Figure A.11 Total chromium leaching after 4-hour shutdown

Task 4 –Testing of Constituent Leaching After Pre-Conditioning at Evoqua Facility Using Dow 2014 Preconditioning Procedure

Formaldehyde concentrations during and after the pre-conditioning process at the Evoqua Facility are summarized in Table A.5. After the preconditioning was complete, the formaldehyde concentration was 13 µg/L in resin effluent. The resin was held saturated overnight. The water held in the vessel contained 112 µg/L formaldehyde when tested on the next morning. After forward flushing, formaldehyde concentration decreased to 5 µg/L. The results indicate that the preconditioning procedure was effective at reducing formaldehyde to below 100 µg/L at the Evoqua Facility.

**Table A.5
Formaldehyde in resin effluent after pre-conditioning
using the Dow 2014 preconditioning procedure**

Sampling Date/Time	Conditions	Formaldehyde
5/7/14 4:00 pm	Chemical preconditioning completed	13 µg/L (lab and field)
5/8/14 8:30 am	Soaking water after the resin was held saturated overnight	112 µg/L (field)
5/8/14 9:25 am	After flushing for 1 hour and 20 minutes	5 µg/L (field)

Task 5 –Testing of Constituent Leaching After Pre-Conditioning at Glendale Using Dow 2014 Preconditioning Procedure

Formaldehyde concentrations in the resin effluent after resin installation at Glendale are shown in Figure A.12. The water used for holding the resin overnight contained 24 µg/L formaldehyde the next morning. Formaldehyde was 15 µg/L after 3 BVs of backwash. With forward flushing, formaldehyde concentrations first increased to 104 µg/L at 64 BVs and then decreased to 91 µg/L at 80 BVs. Formaldehyde results in the next two weeks are summarized in Table A.6. Overall, the results indicate that the 2014 preconditioning procedure was more effective in formaldehyde leaching control than the 2013 procedure. Formaldehyde leaching was below the California notification level of 100 µg/L on the first day of installation (after backwashing and forward flush, totaling 80 BV). These findings indicate that the flushing time may be decreased significantly from approximately two weeks using the 2013 preconditioning procedure to 4 hours using the 2014 procedure.

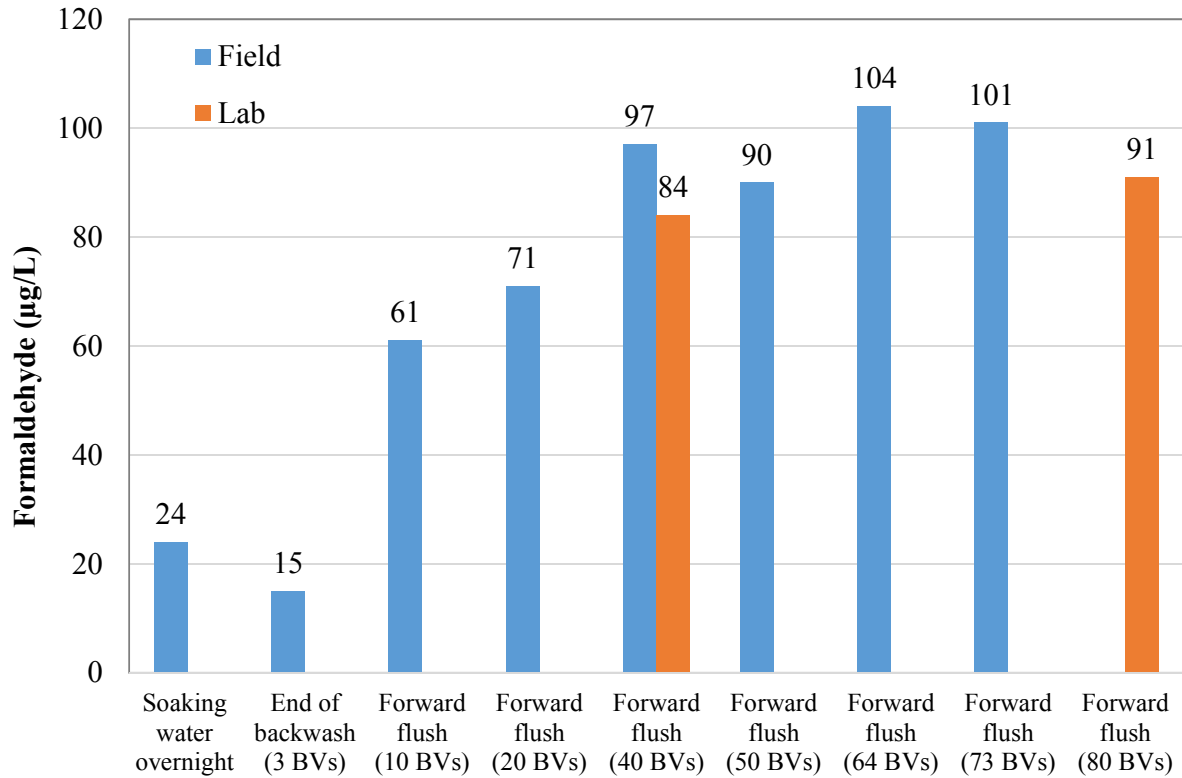

Figure A.12 Formaldehyde leaching from preconditioned resin at Glendale using the 2014 preconditioning procedure

**Table A.6
Formaldehyde in resin effluent after pre-conditioning
at Glendale using the 2014 preconditioning procedure**

Sampling Date	Field Results	Lab Results
Day 4	67 µg/L	68 µg/L
Day 6	58 µg/L	55 µg/L
Day 8	68 µg/L	51 µg/L
Day 11	36 µg/L	38 µg/L
Day 13	27 µg/L	30 µg/L

SUMMARY AND CONCLUSIONS

The Dow 2013 preconditioning procedure effectively reduced formaldehyde below 100 µg/L at the Evoqua Facility. Resin holding test results indicated that preconditioned PWA7 resin held dewatered at 8 hours or longer had the lowest formaldehyde leaching after 20 BVs of forward flushing. The highest formaldehyde concentrations at 20 BVs of forward flushing were observed for resin that was held saturated for two hours.

After the preconditioned resin was dewatered and installed at the Glendale GS-3 site, backwashed and forward flushed, formaldehyde in resin effluent rose to above 400 µg/L and then gradually dropped to below 100 µg/L within two weeks of continuous operation. A similar trend was observed in previous full-scale resin replacements at Glendale. Column tests at Glendale showed that low water pH (6.0) resulted in more formaldehyde leaching from preconditioned resin compared with ambient pH (7.2) water.

Building upon the results from the first part of this study, the 2013 preconditioning procedure was further optimized by Dow and tested in the second part. These results suggest that the 2014 preconditioning procedure combined with holding preconditioned resin in low pH water overnight after installation at Glendale, was more effective than the 2013 procedure in formaldehyde leaching control. Formaldehyde concentrations in the resin effluent after installation at Glendale initially increased then decreased to below the California notification level of 100 µg/L after forward flushing for approximately four hours. This approach provides a much more rapid time to placing the resin in service than offered by the 2013 procedure.

Constituent leaching tests for 72-hour shutdown showed low formaldehyde levels (<20 µg/L) from Dow PWA7 after resuming normal operation, and lower concentrations from Purolite S106 and ResinTech SIR-700. No significant nitrate leaching or peaking was observed for the three resins in the 72-hour shutdown test. No significant Cr(VI) leaching was noted in the 72-hour or 4-hour shutdowns. Total Cr levels in resin effluents were slightly higher than Cr(VI) in the 72-hour shutdown for Purolite S106 and to a lesser extent ResinTechSIR-700, suggesting that only low µg/L levels Cr(III) leached from the resins after an extended shutdown. In the 4-hour shutdown test, Total Cr levels in resin effluents were below 1 µg/L. Overall, formaldehyde, nitrate, Cr(VI) and Total Cr leaching after shutdowns were not a great concern for Dow PWA7, Purolite S106 or ResinTech SIR-700 under the conditions tested.

APPENDIX B: DETAILED COST SHEETS

Table B.1
Estimated AACE Class 5 capital costs for 100-gpm WBA system with Dow PWA7

Description	Quantity	Unit	Unit Cost	Total Cost	Notes
Equipment					
CO ₂ Feed System	1	LS	\$160,000	\$160,000	Quote from TOMCO; 15 lb/hr PSF and 6 ton storage; adjusted to 2014 dollars.
CO ₂ Feed Water Pump	2	EA	\$7,536	\$15,072	Quote from ITT; centrifugal; 15 gpm @ 80 psi; 1 duty/1 stdby; adjusted to 2014 dollars.
Static Mixer	1	EA	\$893	\$893	Quotes from Komax & EWS; 3-inch; adjusted to 2014 dollars.
Bag Filters	2	EA	\$4,500	\$9,000	Quotes from FSI & Ryan Herco; 1 duty/ 1 stdby; adjusted to 2014 dollars.
Ion Exchange Equipment	1	LS	\$55,000	\$55,000	Quotes from Siemens, not including first fill of resin; adjusted to 2014 dollars.
Booster Pump	2	EA	\$8,102	\$16,204	Quote from ITT, 100 gpm @ 15 ft; 1 duty/1 stdby; adjusted to 2014 dollars.
Aeration Equipment	1	LS	\$44,100	\$44,100	Quote from Siemens for an aluminum forced draft aerator (100 gpm), including blower, air distribution tray, and piping etc.; adjusted to 2014 dollars.
Exhaust Blowers	2	EA	\$36,490	\$72,980	Quote from EWS; 267 SCFM @ 2 psi; 1 duty/ 1 stdby; adjusted to 2014 dollars.
Subtotal				\$374,000	Rounded up to \$1000
Equipment Installation Cost	30%			\$112,200	Including tax, freight, installation and manufacturer services.
Equipment Concrete Pad	56	CY	\$1,313	\$74,051	Adjusted to 2014 dollars
Subtotal (Installed Equipment Costs)				\$561,000	Rounded up to \$1000
General Requirements	7.5%			\$42,075	Division 1 requirements, including labor supervision, field offices, temporary utilities, health and safety, office supplies, clean up, photographs, survey, erosion control, coordination, testing services, and record documents
Earthwork	5%			\$28,050	Excavation, backfill, and fill required to construct project
Site Improvements	5%			\$28,050	Roadways, curb and gutter, sidewalk and landscaping
Valves, Piping, and Appurtenances	15%			\$85,000	Major system piping and valves
Electrical, Instrumentation and Controls	15%			\$85,000	PLC and SCADA equipment to control
Total Direct Costs				\$829,000	Rounded up to \$1000
Contractor's Overhead and Profit	20%			\$165,800	Includes bonds, mobilization and demobilization, insurance, overhead and profit, and management reserves
Construction Total				\$994,800	Rounded up to \$1000
Project Level Allowance (contingency)	20%			\$198,960	Budget item to cover change orders due to unforeseen conditions
Engineering, Legal and Administrative	20%			\$198,960	Includes permits, legal fees and engineering fees for design and construction
Initial Fill of Resin	1	LS	\$63,000	\$63,000	Including tax, freight, installation and manufacturer services.
Project Total				\$1,456,000	Rounded up to \$1000
Low Estimate				\$1,019,000	-30%
High Estimate				\$2,184,000	+50%

LS – lump sum; EA – each; CY – cubic yard.

Costs in 2014 US dollars. Costs for land or easements are not included.

Table B.2
Estimated AACE Class 5 capital costs for 500-gpm WBA system with Dow PWA7

Description	Quantity	Unit	Unit Cost	Total Cost	Notes
Equipment					
CO ₂ Feed System	1	LS	\$199,500	\$199,500	Quote from TOMCO; 75 lb/hr PSF and 14 ton storage; adjusted to 2014 dollars.
CO ₂ Feed Water Pump	2	EA	\$7,988	\$15,977	Quote from ITT; centrifugal; 75 gpm @ 80 psi; 1 duty/1 stbby; adjusted to 2014 dollars.
Static Mixers	1	EA	\$2,310	\$2,310	Quotes from Komax & EWS; 8-inch; adjusted to 2014 dollars.
Bag Filters	2	EA	\$13,100	\$26,200	Quotes from FSI & Ryan Herco; 1 duty/ 1 stbby; adjusted to 2014 dollars.
Ion Exchange Equipment	1	LS	\$206,000	\$206,000	Quotes from Siemens and Calgon, not including first fill of resin; adjusted to 2014 dollars.
Booster Pump	2	EA	\$11,469	\$22,938	Quote from ITT, 500 gpm @ 15 ft; 1 duty/1 stbby; adjusted to 2014 dollars.
Aeration Equipment	1	LS	\$49,350	\$49,350	Quote from Siemens for an aluminum forced draft aerator (500 gpm), including blower, air distribution tray, and piping etc.; adjusted to 2014 dollars.
Exhaust Blowers	2	EA	\$56,949	\$113,898	Quotes from EWS & Yardley; 1,500 SCFM @ 5 psi; 1 duty/ 1 stbby; adjusted to 2014 dollars.
Subtotal				\$637,000	Rounded up to \$1000
Equipment Installation Cost	30%			\$191,100	Including tax, freight, installation and manufacturer services.
Equipment Concrete Pad	159	CY	\$1,313	\$209,011	Adjusted to 2014 dollars
Subtotal (Installed Equipment Costs)				\$1,038,000	Rounded up to \$1000
General Requirements	7.5%			\$77,850	Division I requirements, including labor supervision, field offices, temporary utilities, health and safety, office supplies, clean up, photographs, survey, erosion control, coordination, testing services, and record documents
Earthwork	5%			\$51,900	Excavation, backfill, and fill required to construct project
Site Improvements	5%			\$51,900	Roadways, curb and gutter, sidewalk and landscaping
Valves, Piping, and Appurtenances	15%			\$156,000	Major system piping and valves
Electrical, Instrumentation and Controls	15%			\$156,000	PLC and SCADA equipment to control
Total Direct Costs				\$1,532,000	Rounded up to \$1000
Contractor's Overhead and Profit	20%			\$306,400	Includes bonds, mobilization and demobilization, insurance, overhead and profit, and management reserves
Construction Total				\$1,838,000	Rounded up to \$1000
Project Level Allowance (contingency)	20%			\$367,600	Budget item to cover change orders due to unforeseen conditions
Engineering, Legal and Administrative	20%			\$367,600	Includes permits, legal fees and engineering fees for design and construction
Initial Fill of Resin	1	LS	\$316,000	\$316,000	Including tax, freight, installation and manufacturer services.
Project Total				\$2,890,000	Rounded up to \$1000
Low Estimate				\$2,023,000	-30%
High Estimate				\$4,335,000	+50%

LS – lump sum; EA – each; CY – cubic yard.

Costs in 2014 US dollars. Costs for land or easements are not included.

Table B.3
Estimated AACE Class 5 capital costs for 2000-gpm WBA system with Dow PWA7

Description	Quantity	Unit	Unit Cost	Total Cost	Notes
Equipment					
CO ₂ Feed System	1	LS	\$290,000	\$290,000	Quote from TOMCO; 300 lb/hr and 50 ton storage; adjusted to 2014 dollars.
CO ₂ Feed Water Pump	2	EA	\$9,140	\$18,281	Quote from ITT; centrifugal; 305 gpm @ 80 psi; 1 duty/1 stdby; adjusted to 2014 dollars.
Static Mixer	1	EA	\$4,410	\$4,410	Quotes from Komax & EWS; 14-inch; adjusted to 2014 dollars.
Bag Filters	2	EA	\$30,700	\$61,400	Quotes from FSI & Ryan Herco; 1 duty/ 1 stdby; adjusted to 2014 dollars.
Ion Exchange Equipment	1	LS	\$508,000	\$508,000	Quotes from Siemens and Calgon, not including first fill of resin; adjusted to 2014 dollars.
Booster Pump	2	EA	\$25,097	\$50,194	Quote from Cortech, 2,000 gpm @ 15 ft; 1 duty/1 stdby; adjusted to 2014 dollars.
Aeration Equipment	1	LS	\$74,550	\$74,550	Quote from Siemens for an aluminum forced draft aerator (2000 gpm), including blower, air distribution tray, and piping etc.; adjusted to 2014 dollars.
Exhaust Blowers	2	EA	\$141,750	\$283,500	Quote from Yardley; 6,000 SCFM @ 5 psi; 1 duty/ 1 stdby; adjusted to 2014 dollars.
Subtotal				\$1,291,000	Rounded up to \$1000
Equipment Installation Cost	30%			\$387,300	Including tax, freight, installation and manufacturer services.
Equipment Concrete Pad	264	CY	\$1,313	\$346,907	Adjusted to 2012 dollars
Subtotal (Installed Equipment Costs)				\$2,026,000	Rounded up to \$1000
General Requirements	7.5%			\$151,950	Division 1 requirements, including labor supervision, field offices, temporary utilities, health and safety, office supplies, clean up, photographs, survey, erosion control, coordination, testing services, and record documents
Earthwork	5%			\$101,300	Excavation, backfill, and fill required to construct project
Site Improvements	5%			\$101,300	Roadways, curb and gutter, sidewalk and landscaping
Valves, Piping, and Appurtenances	15%			\$304,000	Major system piping and valves
Electrical, Instrumentation and Controls	15%			\$304,000	PLC and SCADA equipment to control
Total Direct Costs				\$2,989,000	Rounded up to \$1000
Contractor's Overhead and Profit	20%			\$597,800	Includes bonds, mobilization and demobilization, insurance, overhead and profit, and management reserves
Construction Total				\$3,587,000	Rounded up to \$1000
Project Level Allowance (contingency)	20%			\$717,400	Budget item to cover change orders due to unforeseen conditions
Engineering, Legal and Administrative	20%			\$717,400	Includes permits, legal fees and engineering fees for design and construction
Initial Fill of Resin	1	LS	\$1,265,000	\$1,265,000	Including tax, freight, installation and manufacturer services.
Project Total				\$6,287,000	Rounded up to \$1000
Low Estimate				\$4,401,000	-30%
High Estimate				\$9,431,000	+50%

LS – lump sum; EA – each; CY – cubic yard.

Costs in 2014 US dollars. Costs for land or easements are not included.

Table B.4
Estimated AACE Class 5 O&M costs for WBA systems with Dow PWA7

System Size (gpm)	Electricity	Chemicals	Resin Replacement (Fresh Resin)	Spent Resin & Wastewater Disposal	Labor	Other Consumables (Bag Filters)	Maintenance and Spare Parts	Lab and Field Analysis	Annual O&M (Rounded up to \$1000)
100	\$12,300	\$9,700	\$17,100	\$12,400	\$52,500	\$130	\$5,600	\$52,000	\$162,000
500	\$52,500	\$48,400	\$72,100	\$46,900	\$52,500	\$530	\$10,400	\$52,000	\$335,000
2000	\$182,500	\$193,400	\$279,500	\$176,300	\$52,500	\$1,600	\$20,300	\$80,000	\$986,000

Costs are in 2014 US dollars.

Table B.5

Estimated AACE Class 5 capital costs for 100-gpm WBA system with ResinTech SIR-700

Description	Quantity	Unit	Unit Cost	Total Cost	Notes
Equipment					
CO ₂ Feed System	1	LS	\$160,000	\$160,000	Quote from TOMCO; 15 lb/hr PSF and 6 ton storage; adjusted to 2014 dollars.
CO ₂ Feed Water Pump	2	EA	\$7,536	\$15,072	Quote from ITT; centrifugal; 15 gpm @ 80 psi; 1 duty/1 stdby; adjusted to 2014 dollars.
Static Mixer	1	EA	\$893	\$893	Quotes from Komax & EWS; 3-inch; adjusted to 2014 dollars.
Bag Filters	2	EA	\$4,500	\$9,000	Quotes from FSI & Ryan Herco; 1 duty/ 1 stdby; adjusted to 2014 dollars.
Ion Exchange Equipment	1	LS	\$55,000	\$55,000	Quotes from Siemens, not including first fill of resin; adjusted to 2014 dollars.
Booster Pump	2	EA	\$8,102	\$16,204	Quote from ITT, 100 gpm @ 15 ft; 1 duty/1 stdby; adjusted to 2014 dollars.
Aeration Equipment	1	LS	\$44,100	\$44,100	Quote from Siemens for an aluminum forced draft aerator (100 gpm), including blower, air distribution tray, and piping etc.; adjusted to 2014 dollars.
Exhaust Blowers	2	EA	\$36,490	\$72,980	Quote from EWS; 267 SCFM @ 2 psi; 1 duty/ 1 stdby; adjusted to 2014 dollars.
Subtotal				\$374,000	Rounded up to \$1000
Equipment Installation Cost	30%			\$112,200	Including tax, freight, installation and manufacturer services.
Equipment Concrete Pad	56	CY	\$1,313	\$74,051	\$1250/CY, adjusted to 2014 dollars
Subtotal (Installed Equipment Costs)				\$561,000	Rounded up to \$1000
General Requirements	7.5%			\$42,075	Division 1 requirements, including labor supervision, field offices, temporary utilities, health and safety, office supplies, clean up, photographs, survey, erosion control, coordination, testing services, and record documents
Earthwork	5%			\$28,050	Excavation, backfill, and fill required to construct project
Site Improvements	5%			\$28,050	Roadways, curb and gutter, sidewalk and landscaping
Valves, Piping, and Appurtenances	15%			\$85,000	Major system piping and valves
Electrical, Instrumentation and Controls	15%			\$85,000	PLC and SCADA equipment to control
Total Direct Costs				\$829,000	Rounded up to \$1000
Contractor's Overhead and Profit	20%			\$165,800	Includes bonds, mobilization and demobilization, insurance, overhead and profit, and management reserves
Construction Total				\$994,800	Rounded up to \$1000
Project Level Allowance (contingency)	20%			\$198,960	Budget item to cover change orders due to unforeseen conditions
Engineering, Legal and Administrative	20%			\$198,960	Includes permits, legal fees and engineering fees for design and construction
Initial Fill of Resin	1	LS	\$38,000	\$38,000	Including tax, freight, installation and manufacturer services.
Project Total				\$1,431,000	Rounded up to \$1000
Low Estimate				\$1,002,000	-30%
High Estimate				\$2,147,000	+50%

LS – lump sum; EA – each; CY – cubic yard.

Costs in 2014 US dollars. Costs for land or easements are not included.

Table B.6

Estimated AACE Class 5 capital costs for 500-gpm WBA system with ResinTech SIR-700

Description	Quantity	Unit	Unit Cost	Total Cost	Notes
Equipment					
CO ₂ Feed System	1	LS	\$199,500	\$199,500	Quote from TOMCO; 75 lb/hr PSF and 14 ton storage; adjusted to 2014 dollars.
CO ₂ Feed Water Pump	2	EA	\$7,988	\$15,977	Quote from ITT; centrifugal; 75 gpm @ 80 psi; 1 duty/1 stdby; adjusted to 2014 dollars.
Static Mixers	1	EA	\$2,310	\$2,310	Quotes from Komax & EWS; 8-inch; adjusted to 2014 dollars.
Bag Filters	2	EA	\$13,100	\$26,200	Quotes from FSI & Ryan Herco; 1 duty/ 1 stdby; adjusted to 2014 dollars.
Ion Exchange Equipment	1	LS	\$206,000	\$206,000	Quotes from Siemens, not including first fill of resin; adjusted to 2014 dollars.
Booster Pump	2	EA	\$11,469	\$22,938	Quote from ITT, 500 gpm @ 15 ft; 1 duty/1 stdby; adjusted to 2014 dollars.
Aeration Equipment	1	LS	\$49,350	\$49,350	Quote from Siemens for an aluminum forced draft aerator (500 gpm), including blower, air distribution tray, and piping etc.; adjusted to 2014 dollars.
Exhaust Blowers	2	EA	\$56,949	\$113,898	Quotes from EWS & Yardley; 1,500 SCFM @ 5 psi; 1 duty/ 1 stdby; adjusted to 2014 dollars.
Subtotal				\$637,000	Rounded up to \$1000
Equipment Installation Cost	30%			\$191,100	Including tax, freight, installation and manufacturer services.
Equipment Concrete Pad	159	CY	\$1,313	\$209,011	\$1250/CY, adjusted to 2014 dollars
Subtotal (Installed Equipment Costs)				\$1,038,000	Rounded up to \$1000
General Requirements	7.5%			\$77,850	Division 1 requirements, including labor supervision, field offices, temporary utilities, health and safety, office supplies, clean up, photographs, survey, erosion control, coordination, testing services, and record documents
Earthwork	5%			\$51,900	Excavation, backfill, and fill required to construct project
Site Improvements	5%			\$51,900	Roadways, curb and gutter, sidewalk and landscaping
Valves, Piping, and Appurtenances	15%			\$156,000	Major system piping and valves
Electrical, Instrumentation and Controls	15%			\$156,000	PLC and SCADA equipment to control
Total Direct Costs				\$1,532,000	Rounded up to \$1000
Contractor's Overhead and Profit	20%			\$306,400	Includes bonds, mobilization and demobilization, insurance, overhead and profit, and management reserves
Construction Total				\$1,838,000	Rounded up to \$1000
Project Level Allowance (contingency)	20%			\$367,600	Budget item to cover change orders due to unforeseen conditions
Engineering, Legal and Administrative	20%			\$367,600	Includes permits, legal fees and engineering fees for design and construction
Initial Fill of Resin	1	LS	\$189,000	\$189,000	Including tax, freight, installation and manufacturer services.
Project Total				\$2,763,000	Rounded up to \$1000
Low Estimate				\$1,934,000	-30%
High Estimate				\$4,145,000	+50%

LS – lump sum; EA – each; CY – cubic yard.

Costs in 2014 US dollars. Costs for land or easements are not included.

Table B.7
Estimated AACE Class 5 capital costs for 2000-gpm WBA system with ResinTech SIR-700

Description	Quantity	Unit	Unit Cost	Total Cost	Notes
Equipment					
CO ₂ Feed System	1	LS	\$290,000	\$290,000	Quote from TOMCO; 300 lb/hr and 50 ton storage; adjusted to 2014 dollars.
CO ₂ Feed Water Pump	2	EA	\$9,140	\$18,281	Quote from ITT; centrifugal; 305 gpm @ 80 psi; 1 duty/1 stdby; adjusted to 2014 dollars.
Static Mixer	1	EA	\$4,410	\$4,410	Quotes from Komax & EWS; 14-inch; adjusted to 2014 dollars.
Bag Filters	2	EA	\$30,700	\$61,400	Quotes from FSI & Ryan Herco; 1 duty/ 1 stdby; adjusted to 2014 dollars.
Ion Exchange Equipment	1	LS	\$508,000	\$508,000	Quotes from Siemens, not including first fill of resin; adjusted to 2014 dollars.
Booster Pump	2	EA	\$25,097	\$50,194	Quote from Cortech, 2,000 gpm @ 15 ft; 1 duty/1 stdby; adjusted to 2014 dollars.
Aeration Equipment	1	LS	\$74,550	\$74,550	Quote from Siemens for an aluminum forced draft aerator (2000 gpm), including blower, air distribution tray, and piping etc.; adjusted to 2014 dollars.
Exhaust Blowers	2	EA	\$141,750	\$283,500	Quote from Yardley; 6,000 SCFM @ 5 psi; 1 duty/ 1 stdby; adjusted to 2014 dollars.
Subtotal				\$1,291,000	Rounded up to \$1000
Equipment Installation Cost	30%			\$387,300	Including tax, freight, installation and manufacturer services.
Equipment Concrete Pad	264	CY	\$1,313	\$346,907	\$1250/CY, adjusted to 2012 dollars
Subtotal (Installed Equipment Costs)				\$2,026,000	Rounded up to \$1000
General Requirements	7.5%			\$151,950	Division 1 requirements, including labor supervision, field offices, temporary utilities, health and safety, office supplies, clean up, photographs, survey, erosion control, coordination, testing services, and record documents
Earthwork	5%			\$101,300	Excavation, backfill, and fill required to construct project
Site Improvements	5%			\$101,300	Roadways, curb and gutter, sidewalk and landscaping
Valves, Piping, and Appurtenances	15%			\$304,000	Major system piping and valves
Electrical, Instrumentation and Controls	15%			\$304,000	PLC and SCADA equipment to control
Total Direct Costs				\$2,989,000	Rounded up to \$1000
Contractor's Overhead and Profit	20%			\$597,800	Includes bonds, mobilization and demobilization, insurance, overhead and profit, and management reserves
Construction Total				\$3,587,000	Rounded up to \$1000
Project Level Allowance (contingency)	20%			\$717,400	Budget item to cover change orders due to unforeseen conditions
Engineering, Legal and Administrative	20%			\$717,400	Includes permits, legal fees and engineering fees for design and construction
Initial Fill of Resin	1	LS	\$757,000	\$757,000	Including tax, freight, installation and manufacturer services.
Project Total				\$5,779,000	Rounded up to \$1000
Low Estimate				\$4,045,000	-30%
High Estimate				\$8,669,000	+50%

LS – lump sum; EA – each; CY – cubic yard.

Costs in 2014 US dollars. Costs for land or easements are not included.

Table B.8
Estimated AACE Class 5 O&M costs for WBA systems with ResinTech SIR-700

System Size (gpm)	Electricity	Chemicals	Resin Replacement (Fresh Resin)	Spent Resin & Wastewater Disposal	Labor	Other Consumables (Bag Filters)	Maintenance and Spare Parts	Lab and Field Analysis	Annual O&M (Rounded up to \$1000)
100	\$12,300	\$9,700	\$11,600	\$13,200	\$52,500	\$130	\$5,600	\$52,000	\$157,000
500	\$52,500	\$48,400	\$43,600	\$46,900	\$52,500	\$530	\$10,400	\$52,000	\$307,000
2000	\$182,500	\$193,400	\$168,000	\$176,300	\$52,500	\$1,600	\$20,300	\$80,000	\$875,000

Costs are in 2014 US dollars.

Table B.9
Estimated AACE Class 5 capital costs for 100-gpm WBA system with Purolite S106

Description	Quantity	Unit	Unit Cost	Total Cost	Notes
Equipment					
CO ₂ Feed System	1	LS	\$160,000	\$160,000	Quote from TOMCO; 15 lb/hr PSF and 6 ton storage; adjusted to 2014 dollars.
CO ₂ Feed Water Pump	2	EA	\$7,536	\$15,072	Quote from ITT; centrifugal; 15 gpm @ 80 psi; 1 duty/1 stdby; adjusted to 2014 dollars.
Static Mixer	1	EA	\$893	\$893	Quotes from Komax & EWS; 3-inch; adjusted to 2014 dollars.
Bag Filters	2	EA	\$4,500	\$9,000	Quotes from FSI & Ryan Herco; 1 duty/ 1 stdby; adjusted to 2014 dollars.
Ion Exchange Equipment	1	LS	\$55,000	\$55,000	Quotes from Siemens, not including first fill of resin; adjusted to 2014 dollars.
Booster Pump	2	EA	\$8,102	\$16,204	Quote from ITT, 100 gpm @ 15 ft; 1 duty/1 stdby; adjusted to 2014 dollars.
Aeration Equipment	1	LS	\$44,100	\$44,100	Quote from Siemens for an aluminum forced draft aerator (100 gpm), including blower, air distribution tray, and piping etc.; adjusted to 2014 dollars.
Exhaust Blowers	2	EA	\$36,490	\$72,980	Quote from EWS; 267 SCFM @ 2 psi; 1 duty/ 1 stdby; adjusted to 2014 dollars.
Subtotal				\$374,000	Rounded up to \$1000
Equipment Installation Cost	30%			\$112,200	Including tax, freight, installation and manufacturer services.
Equipment Concrete Pad	56	CY	\$1,313	\$74,051	\$1250/CY, adjusted to 2014 dollars
Subtotal (Installed Equipment Costs)				\$561,000	Rounded up to \$1000
General Requirements	7.5%			\$42,075	Division 1 requirements, including labor supervision, field offices, temporary utilities, health and safety, office supplies, clean up, photographs, survey, erosion control, coordination, testing services, and record documents
Earthwork	5%			\$28,050	Excavation, backfill, and fill required to construct project
Site Improvements	5%			\$28,050	Roadways, curb and gutter, sidewalk and landscaping
Valves, Piping, and Appurtenances	15%			\$85,000	Major system piping and valves
Electrical, Instrumentation and Controls	15%			\$85,000	PLC and SCADA equipment to control
Total Direct Costs				\$829,000	Rounded up to \$1000
Contractor's Overhead and Profit	20%			\$165,800	Includes bonds, mobilization and demobilization, insurance, overhead and profit, and management reserves
Construction Total				\$994,800	Rounded up to \$1000
Project Level Allowance (contingency)	20%			\$198,960	Budget item to cover change orders due to unforeseen conditions
Engineering, Legal and Administrative	20%			\$198,960	Includes permits, legal fees and engineering fees for design and construction
Initial Fill of Resin	1	LS	\$39,000	\$39,000	Including tax, freight, installation and manufacturer services.
Project Total				\$1,432,000	Rounded up to \$1000
Low Estimate				\$1,002,000	-30%
High Estimate				\$2,148,000	+50%

LS – lump sum; EA – each; CY – cubic yard.

Costs in 2014 US dollars. Costs for land or easements are not included.

Table B.10
Estimated AACE Class 5 capital costs for 500-gpm WBA system with Purolite S106

Description	Quantity	Unit	Unit Cost	Total Cost	Notes
Equipment					
CO2 Feed System	1	LS	\$199,500	\$199,500	Quote from TOMCO; 75 lb/hr PSF and 14 ton storage; adjusted to 2014 dollars.
CO2 Feed Water Pump	2	EA	\$7,988	\$15,977	Quote from ITT; centrifugal; 75 gpm @ 80 psi; 1 duty/1 stdby; adjusted to 2014 dollars.
Static Mixers	1	EA	\$2,310	\$2,310	Quotes from Komax & EWS; 8-inch; adjusted to 2014 dollars.
Bag Filters	2	EA	\$13,100	\$26,200	Quotes from FSI & Ryan Herco; 1 duty/ 1 stdby; adjusted to 2014 dollars.
Ion Exchange Equipment	1	LS	\$206,000	\$206,000	Quotes from Siemens, not including first fill of resin; adjusted to 2014 dollars.
Booster Pump	2	EA	\$11,469	\$22,938	Quote from ITT, 500 gpm @ 15 ft; 1 duty/1 stdby; adjusted to 2014 dollars.
Aeration Equipment	1	LS	\$49,350	\$49,350	Quote from Siemens for an aluminum forced draft aerator (500 gpm), including blower, air distribution tray, and piping etc.; adjusted to 2014 dollars.
Exhaust Blowers	2	EA	\$56,949	\$113,898	Quotes from EWS & Yardley; 1,500 SCFM @ 5 psi; 1 duty/ 1 stdby; adjusted to 2014 dollars.
Subtotal				\$637,000	Rounded up to \$1000
Equipment Installation Cost	30%			\$191,100	Including tax, freight, installation and manufacturer services.
Equipment Concrete Pad	159	CY	\$1,313	\$209,011	\$1250/CY, adjusted to 2014 dollars
Subtotal (Installed Equipment Costs)				\$1,038,000	Rounded up to \$1000
General Requirements	7.5%			\$77,850	Division I requirements, including labor supervision, field offices, temporary utilities, health and safety, office supplies, clean up, photographs, survey, erosion control, coordination, testing services, and record documents
Earthwork	5%			\$51,900	Excavation, backfill, and fill required to construct project
Site Improvements	5%			\$51,900	Roadways, curb and gutter, sidewalk and landscaping
Valves, Piping, and Appurtenances	15%			\$156,000	Major system piping and valves
Electrical, Instrumentation and Controls	15%			\$156,000	PLC and SCADA equipment to control
Total Direct Costs				\$1,532,000	Rounded up to \$1000
Contractor's Overhead and Profit	20%			\$306,400	Includes bonds, mobilization and demobilization, insurance, overhead and profit, and management reserves
Construction Total				\$1,838,000	Rounded up to \$1000
Project Level Allowance (contingency)	20%			\$367,600	Budget item to cover change orders due to unforeseen conditions
Engineering, Legal and Administrative	20%			\$367,600	Includes permits, legal fees and engineering fees for design and construction
Initial Fill of Resin	1	LS	\$156,000	\$156,000	Including tax, freight, installation and manufacturer services.
Project Total				\$2,730,000	Rounded up to \$1000
Low Estimate				\$1,911,000	-30%
High Estimate				\$4,095,000	+50%

LS – lump sum; EA – each; CY – cubic yard.

Costs in 2014 US dollars. Costs for land or easements are not included.

Table B.11
Estimated AACE Class 5 capital costs for 2000-gpm WBA system with Purolite S106

Description	Quantity	Unit	Unit Cost	Total Cost	Notes
Equipment					
CO2 Feed System	1	LS	\$290,000	\$290,000	Quote from TOMCO; 300 lb/hr and 50 ton storage; adjusted to 2014 dollars.
CO2 Feed Water Pump	2	EA	\$9,140	\$18,281	Quote from ITT; centrifugal; 305 gpm @ 80 psi; 1 duty/1 stdby; adjusted to 2014 dollars.
Static Mixer	1	EA	\$4,410	\$4,410	Quotes from Komax & EWS; 14-inch; adjusted to 2014 dollars.
Bag Filters	2	EA	\$30,700	\$61,400	Quotes from FSI & Ryan Herco; 1 duty/ 1 stdby; adjusted to 2014 dollars.
Ion Exchange Equipment	1	LS	\$508,000	\$508,000	Quotes from Siemens, not including first fill of resin; adjusted to 2014 dollars.
Booster Pump	2	EA	\$25,097	\$50,194	Quote from Cortech, 2,000 gpm @ 15 ft; 1 duty/1 stdby; adjusted to 2014 dollars.
Aeration Equipment	1	LS	\$74,550	\$74,550	Quote from Siemens for an aluminum forced draft aerator (2000 gpm), including blower, air distribution tray, and piping etc.; adjusted to 2014 dollars.
Exhaust Blowers	2	EA	\$141,750	\$283,500	Quote from Yardley; 6,000 SCFM @ 5 psi; 1 duty/ 1 stdby; adjusted to 2014 dollars.
Subtotal				\$1,291,000	Rounded up to \$1000
Equipment Installation Cost	30%			\$387,300	Including tax, freight, installation and manufacturer services.
Equipment Concrete Pad	264	CY	\$1,313	\$346,907	\$1250/CY, adjusted to 2012 dollars
Subtotal (Installed Equipment Costs)				\$2,026,000	Rounded up to \$1000
General Requirements	7.5%			\$151,950	Division 1 requirements, including labor supervision, field offices, temporary utilities, health and safety, office supplies, clean up, photographs, survey, erosion control, coordination, testing services, and record documents
Earthwork	5%			\$101,300	Excavation, backfill, and fill required to construct project
Site Improvements	5%			\$101,300	Roadways, curb and gutter, sidewalk and landscaping
Valves, Piping, and Appurtenances	15%			\$304,000	Major system piping and valves
Electrical, Instrumentation and Controls	15%			\$304,000	PLC and SCADA equipment to control
Total Direct Costs				\$2,989,000	Rounded up to \$1000
Contractor's Overhead and Profit	20%			\$597,800	Includes bonds, mobilization and demobilization, insurance, overhead and profit, and management reserves
Construction Total				\$3,587,000	Rounded up to \$1000
Project Level Allowance (contingency)	20%			\$717,400	Budget item to cover change orders due to unforeseen conditions
Engineering, Legal and Administrative	20%			\$717,400	Includes permits, legal fees and engineering fees for design and construction
Initial Fill of Resin	1	LS	\$593,000	\$593,000	Including tax, freight, installation and manufacturer services.
Project Total				\$5,615,000	Rounded up to \$1000
Low Estimate				\$3,931,000	-30%
High Estimate				\$8,423,000	+50%

LS – lump sum; EA – each; CY – cubic yard.

Costs in 2014 US dollars. Costs for land or easements are not included.

Table B.12
Estimated AACE Class 5 O&M costs for WBA systems with Purolite S106 (150,000 BVs)

System Size (gpm)	Electricity	Chemicals	Resin Replacement (Fresh Resin)	Spent Resin & Wastewater Disposal	Labor	Other Consumables (Bag Filters)	Maintenance and Spare Parts	Lab and Field Analysis	Annual O&M (Rounded up to \$1000)
100	\$12,300	\$9,700	\$26,100	\$20,100	\$52,500	\$130	\$5,600	\$52,000	\$178,000
500	\$52,500	\$48,400	\$76,300	\$85,200	\$52,500	\$530	\$10,400	\$52,000	\$378,000
2000	\$182,500	\$193,400	\$257,200	\$329,400	\$52,500	\$1,600	\$20,300	\$80,000	\$1,117,000

Costs are in 2014 US dollars.

Table B.13
Estimated AACE Class 5 O&M costs for WBA systems with Purolite S106 (260,000 BVs)

System Size (gpm)	Electricity	Chemicals	Resin Replacement (Fresh Resin)	Spent Resin & Wastewater Disposal	Labor	Other Consumables (Bag Filters)	Maintenance and Spare Parts	Lab and Field Analysis	Annual O&M (Rounded up to \$1000)
100	\$12,300	\$9,700	\$15,100	\$13,200	\$52,500	\$130	\$5,600	\$52,000	\$161,000
500	\$52,500	\$48,400	\$44,000	\$50,900	\$52,500	\$530	\$10,400	\$52,000	\$311,000
2000	\$182,500	\$193,400	\$148,400	\$192,200	\$52,500	\$1,600	\$20,300	\$80,000	\$871,000

Costs are in 2014 US dollars.

Table B.14
Estimated AACE Class 5 capital costs for 100-gpm RCF system with recycle

Description	Quantity	Unit	Unit Cost	Total Cost	Notes
Equipment					
FeSO ₄ Feed System					
Storage Tank	1	EA	\$2,800	\$2,800	Quotes from Ryan Herco & Core-Rosion; 100 gal PE, outdoor, incl. seismic; adjusted to 2014 dollars
Metering Pumps	2	EA	\$3,200	\$6,400	Quotes from C.P. Crowley & HTP; 0.25 gph; 1 duty/ 1 stdby; adjusted to 2014 dollars
Static Mixers	1	EA	\$900	\$900	Quotes from Komax & EWS; 3-inch; adjusted to 2014 dollars
Reduction Tank					
Tank	1	EA	\$5,400	\$5,400	Quotes from Core-Rosion & Ryan Herco; 1,700 gal PE, outdoor, incl. seismic; adjusted to 2014 dollars
Mixer	1	EA	\$4,900	\$4,900	Quotes from Core-Rosion & EWS; G = 60 per second; adjusted to 2014 dollars
NaOCl Feed System					
Storage Tank	1	LS	\$600	\$600	Quote from Polyprocessing; 55 gal, HDPE, outdoor, incl. seismic, adjusted to 2014 dollars
Metering Pumps	2	EA	\$4,800	\$9,600	Quote from Prominent; 0.06 gph, 1 duty/ 1 stdby; adjusted to 2014 dollars
Static Mixers	1	EA	\$900	\$900	Quotes from Komax & EWS; 3-inch; adjusted to 2014 dollars.
Chlorine Contact Tank	1	EA	\$3,800	\$3,800	Quotes from Core-Rosion & Ryan Herco; 700 gal PE, outdoor, incl. seismic; adjusted to 2014 dollars
Polymer Mixing Tank					
Rapid Mixing Tank	1	EA	\$3,800	\$3,800	Quotes from Core-Rosion & Ryan Herco; 700 gal PE, outdoor, incl. seismic; adjusted to 2014 dollars
Mixer	1	EA	\$3,900	\$3,900	Quotes from Core-Rosion & EWS; G = 170 per second; adjusted to 2014 dollars
Filters					
Filter Equipment (Pressure Filters)	1	LS	\$294,000	\$294,000	Quotes from Coombs-Hopkins & Layne, including media; 3 gpm/sf, (2) 6.5 ft dia VPF, 1 duty/ 1 stdby; adjusted to 2014 dollars
Filter Drawdown Transfer Pump	2	EA	\$5,900	\$11,800	Quotes from DTI and Cortech; 55 gpm @ 70 ft; 1 duty/ 1 stdby; adjusted to 2014 dollars
Pumps					
Filter Feed Pumps (Progressive Cavity)	2	EA	\$13,000	\$26,000	Quotes from Cortech & Flow-Systems; 100 gpm @ 70 ft; 1 duty/ 1 stdby; adjusted to 2014 dollars
Polymer Feed Systems					
Polymer Feed System (Coagulant Aid)	1	LS	\$29,000	\$29,000	Quotes from Siemens & C.P. Crowley; adjusted to 2014 dollars
Polymer Feed System (Solids Settling Aid)	1	LS	\$11,000	\$11,000	Quotes from Siemens & C.P. Crowley; adjusted to 2014 dollars
Filtrate Tank for Backwash	1	EA	\$27,500	\$27,500	Quotes from Core-Rosion & Ryan Herco; 12,500 gal PE, outdoor, incl. seismic; adjusted to 2014 dollars
Backwash Pumps	2	EA	\$9,300	\$18,600	Quotes from ITT & Cortech; 600 gpm @ 50 ft; 1 duty/ 1stdby; adjusted to 2014 dollars
Residuals Treatment System					
Gravity Thickener	2	EA	\$34,000	\$68,000	Quote from Plastic-Mart for 13,000-gallon cone bottom tank with stand; adjusted to 2014 dollars
Flo-Trend SludgeMate Container	2	EA	\$14,900	\$29,800	Quote from Flo-Trend for 6-CY SludgeMate container; adjusted to 2014 dollars
Pumps	1	LS	\$10,500	\$10,500	Includes all sludge pumps and recycle pumps, one duty and one standby; adjusted to 2014 dollars

(continued)

Table B.14 continued

Description	Quantity	Unit	Unit Cost	Total Cost	Notes
Subtotal				\$570,000	Rounded up to \$1000
Equipment Installation Cost	30%			\$171,000	Including tax, freight, installation and manufacturer services.
Chemical Storage Containment	2	CY	\$1,313	\$2,625	Adjusted to 2014 dollars
Equipment Concrete Pads	69	CY	\$1,313	\$90,563	Adjusted to 2014 dollars
Subtotal (Installed Equipment Costs)				\$835,000	Rounded up to \$1000
General Requirements	7.5%			\$62,625	Division 1 requirements, including labor supervision, field offices, temporary utilities, health and safety, office supplies, clean up, photographs, survey, erosion control, coordination, testing services, and record documents
Earthwork	5%			\$41,750	Excavation, backfill, and fill required to construct project
Site Improvements	5%			\$41,750	Roadways, curb and gutter, sidewalk and landscaping
Valves, Piping, and Appurtenances	15%			\$126,000	Major system piping and valves
Electrical, Instrumentation and Controls	15%			\$126,000	PLC and SCADA equipment to control
Total Direct Costs				\$1,233,000	Rounded up to \$1000
Contractor's Overhead and Profit	20%			\$246,600	Includes bonds, mobilization and demobilization, insurance, overhead and profit, and management reserves
Construction Total				\$1,480,000	Rounded up to \$1000
Project Level Allowance (contingency)	20%			\$296,000	Budget item to cover change orders due to unforeseen conditions
Engineering, Legal and Administrative	20%			\$296,000	Includes permits, legal fees and engineering fees for design and construction
Project Total				\$2,072,000	Rounded up to \$1000
Low Estimate				\$1,450,000	-30%
High Estimate				\$3,108,000	+50%

LS – lump sum; EA – each; CY – cubic yard.
 Costs are in 2014 US dollars.
 Costs for land or easements are not included.

Table B.15
Estimated AACE Class 5 capital costs for 500-gpm RCF system with recycle

Description	Quantity	Unit	Unit Cost	Total Cost	Notes
Equipment					
FeSO ₄ Feed System					
Storage Tank	1	EA	\$3,500	\$3,500	Quotes from Core-Rosion & Ryan Herco; 500 gal PE, outdoor, incl. seismic; adjusted to 2014 dollars.
Metering Pumps	2	EA	\$3,200	\$6,400	Quotes from C.P. Crowley & HTP; 1.3 gph; 1 duty/ 1 stdby; adjusted to 2014 dollars.
Static Mixers	1	EA	\$2,300	\$2,300	Quotes from Komax & EWS; 8-inch; adjusted to 2014 dollars.
Reduction Tank					
Tank	1	EA	\$21,000	\$21,000	Quotes from Core-Rosion & Ryan Herco; 8,000 gal PE, outdoor, incl. seismic; adjusted to 2014 dollars.
Mixer	1	EA	\$9,200	\$9,200	Quotes from Core-Rosion & EWS; G = 60 per second; adjusted to 2014 dollars.
NaOCl Feed System					
Storage Tank	1	EA	\$1,000	\$1,000	Quote from Polyprocessing; 115 gal, HDPE, outdoor, incl. seismic; adjusted to 2014 dollars.
Metering Pumps	2	EA	\$4,800	\$9,600	Quote from Prominent; 0.30 gph, 1 duty/ 1 stdby; adjusted to 2014 dollars.
Static Mixers	1	EA	\$2,300	\$2,300	Quotes from Komax & EWS; 8-inch; adjusted to 2014 dollars.
Chlorine Contact Tank	1	EA	\$7,100	\$7,100	Quotes from Core-Rosion & Ryan Herco; 3000 gal PE, outdoor, incl. seismic; adjusted to 2014 dollars.
Polymer Mixing Tank					
Rapid Mixing Tank	1	EA	\$7,100	\$7,100	Quotes from Core-Rosion & Ryan Herco; 3000 gal PE, outdoor, incl. seismic; adjusted to 2014 dollars.
Mixers	1	EA	\$4,600	\$4,600	Quotes from Core-Rosion & EWS; G = 170 per second; adjusted to 2014 dollars.
Filters					
Filter Equipment (Pressure Filters)	1	LS	\$489,000	\$489,000	Quotes from Coombs-Hopkins & Layne, including media; 3 gpm/sf; Coombs-Hopkins filters, 10' x 24' (4 cells, 3 duty/ 1 stdby); Layne filters, (2) 8" x 22', 1 duty/ 1 stdby; adjusted to 2014 dollars.
Filter Drawdown Transfer Pump	2	EA	\$5,000	\$10,000	Quotes from ITT and Cortech; 150 gpm @ 70 ft; 1 duty/ 1 stdby; adjusted to 2014 dollars.
Pumps					
Filter Feed Pumps (Progressive Cavity)	2	EA	\$40,000	\$80,000	Quotes from Cortech & Flow-Systems; 500 gpm @ 70 ft; 1 duty/ 1 stdby; adjusted to 2014 dollars.
Polymer Feed Systems					
Polymer Feed Systems (Coagulant Aid)	1	LS	\$11,000	\$11,000	Quotes from Siemens & C.P. Crowley; adjusted to 2014 dollars.
Polymer Feed Systems (Solids Settling Aid)	1	LS	\$11,900	\$11,900	Quotes from Siemens & C.P. Crowley; adjusted to 2014 dollars.
Filtrate Tank for Backwash	1	EA	\$42,000	\$42,000	Quotes from Superior; 22,000 gal; 15 ft dia x 16 ft height; adjusted to 2014 dollars.
Backwash Pumps	2	EA	\$15,100	\$30,200	Quotes from ITT & Cortech; 1,050 gpm @ 50 ft; 1 duty/ 1stdby; adjusted to 2014 dollars.
Residuals Treatment System					
Equalization Tank	1	EA	\$127,000	\$121,154	Adjusted installed costs from RS Means for 90,000-gal tank, which was divided by 1.3 to exclude installation cost (assuming a installation cost of 30%); adjusted to 2014 dollars.
Plate Settler	1	EA	\$61,000	\$61,000	Quote from Meurer Research, Inc. and Parkson for a system handles a 26-gpm sludge flow; adjusted to 2014 dollars.

(continued)

Table B.15 continued

Description	Quantity	Unit	Unit Cost	Total Cost	Notes
Flo-Trend SludgeMate Container	3	EA	\$27,100	\$81,300	Quote from Flo-Trend for 15-CY SludgeMate container; adjusted to 2014 dollars.
Pumps	1	LS	\$15,750	\$15,750	Includes all sludge pumps and recycle pumps, one duty and one standby; adjusted to 2014 dollars.
Subtotal				\$1,028,000	Rounded up to \$1000
Equipment Installation Cost	30%			\$309,000	Including tax, freight, installation and manufacturer services.
Chemical Storage Containment	6	CY	\$1,313	\$7,875	Adjusted to 2014 dollars
Equipment Concrete Pads	166	CY	\$1,313	\$217,875	Adjusted to 2014 dollars
Subtotal (Installed Equipment Costs)				\$1,563,000	Rounded up to \$1000
General Requirements	7.5%			\$117,225	Division 1 requirements, including labor supervision, field offices, temporary utilities, health and safety, office supplies, clean up, photographs, survey, erosion control, coordination, testing services, and record documents
Earthwork	5%			\$78,150	Excavation, backfill, and fill required to construct project
Site Improvements	5%			\$78,150	Roadways, curb and gutter, sidewalk and landscaping
Valves, Piping, and Appurtenances	15%			\$235,000	Major system piping and valves
Electrical, Instrumentation and Controls	15%			\$235,000	PLC and SCADA equipment to control
Total Direct Costs				\$2,307,000	Rounded up to \$1000
Contractor's Overhead and Profit	20%			\$461,400	Includes bonds, mobilization and demobilization, insurance, overhead and profit, and management reserves
Construction Total				\$2,768,000	Rounded up to \$1000
Project Level Allowance (contingency)	20%			\$553,600	Budget item to cover change orders due to unforeseen conditions
Engineering, Legal and Administrative	20%			\$553,600	Includes permits, legal fees and engineering fees for design and construction
Project Total				\$3,876,000	Rounded up to \$1000
Low Estimate				\$2,713,000	-30%
High Estimate				\$5,814,000	+50%

LS – lump sum; EA – each; CY – cubic yard.
 Costs are in 2014 US dollars.
 Costs for land or easements are not included.

Table B.16
Estimated AACE Class 5 capital costs for 2000-gpm RCF system with recycle

Description	Quantity	Unit	Unit Cost	Total Cost	Notes
Equipment					
FeSO ₄ Feed System					
Storage Tank	1	EA	\$6,200	\$6,200	Quotes from Core-Rosion & Ryan Herco; 2,000 gal PE, outdoor, incl. seismic; adjusted to 2014 dollars
Metering Pumps	2	EA	\$6,300	\$12,600	Quotes from C.P. Crowley & HTP; 5 gph; adjusted to 2014 dollars
Static Mixers	1	EA	\$4,400	\$4,400	Quotes from Komax & EWS; 14-inch; adjusted to 2014 dollars
Reduction Tank					
Mixers	1	EA	\$24,700	\$24,700	Quotes from Core-Rosion & EWS; G = 60 per second; adjusted to 2014 dollars
NaOCl Feed System					
Storage Tank	1	LS	\$2,400	\$2,400	Quote from Polyprocessing; 475 gal, HDPE, outdoor, incl. seismic; adjusted to 2014 dollars
Metering Pumps	2	EA	\$4,800	\$9,600	Quote from Prominent; 1.22 gph, 1 duty/ 1 stdby; adjusted to 2014 dollars
Static Mixers	1	EA	\$4,400	\$4,400	Quotes from Komax & EWS; 14-inch; adjusted to 2014 dollars.
Polymer Mixing Tanks					
Mixers	1	EA	\$17,900	\$17,900	Quotes from Core-Rosion & EWS; G = 170 per second; adjusted to 2014 dollars
Filters					
Filter Equipment (Pressure Filters)	1	LS	\$1,033,000	\$1,033,000	Quotes from Tonka & Layne, including media; 3 gpm/sf; Tonka filters, (2) 10' x 42', 4 cells per filter, 3 duty / 1 stdby; Layne filters, (4) 10' x 24', 3 duty/ 1 stdby; adjusted to 2014 dollars
Filter Drawdown Transfer Pump	2	EA	\$5,300	\$10,600	Quotes from ITT and Cortech; 150 gpm @ 70 ft; 1 duty/ 1 stdby; adjusted to 2012 dollars
Pumps					
Filter Feed Pumps (Progressive Cavity)	3	EA	\$57,000	\$171,000	Quotes from Cortech & Flow-Systems; 1,000 gpm @ 70 ft; 2 duty/ 1 stdby; adjusted to 2014 dollars
Polymer Feed Systems					
Polymer Feed Systems (Coagulant Aid)	1	LS	\$11,000	\$11,000	Quotes from Siemens & C.P. Crowley; adjusted to 2014 dollars
Polymer Feed Systems (Solids Settling Aid)	1	LS	\$11,900	\$11,900	Quotes from Siemens & C.P. Crowley; adjusted to 2014 dollars
Filtrate Tank for Backwash	1	EA	\$52,500	\$52,500	Quotes from Superior; 30,250 gal; 18 ft dia x 16 ft height; adjusted to 2014 dollars
Backwash Pumps	2	EA	\$22,500	\$45,000	Quotes from ITT & Cortech; 1,450 gpm @ 50 ft; 1 duty/ 1stdby; adjusted to 2014 dollars
Residuals Treatment System					
Equalization Tank	1	EA	\$144,000	\$137,385	Adjusted installed costs from RS Means for 280,000-gal tank, which was divided by 1.3 to exclude installation cost (assuming a installation cost of 30%); adjusted to 2014 dollars
Plate Settler	1	EA	\$81,000	\$81,000	Quote from Meurer Research, Inc. and Parkson for a system handles a 88-gpm sludge flow; adjusted to 2014 dollars
Flo-Trend SludgeMate Container	3	EA	\$40,400	\$121,200	Quote from Flo-Trend for 40-CY SludgeMate container; adjusted to 2014 dollars

(continued)

Table B.16 continued

Description	Quantity	Unit	Unit Cost	Total Cost	Notes
Pumps	1	LS	\$23,000	\$23,000	Includes sludge pumps and recycle pumps for equalization tank and plate settlers, one duty and one standby; adjusted to 2014 dollars.
Subtotal				\$1,780,000	Rounded up to \$1000
Equipment Installation Cost (30% of Equipment)	30%			\$534,000	Including tax, freight, installation and manufacturer services.
Reduction Tanks					
Slab	62	CY	\$735	\$45,570	Based on 2 ft slab or wall; \$735/CY; adjusted to 2014 dollars.
Walls	63	CY	\$840	\$52,920	Based on 2 ft slab or wall; and 2 ft freeboard; \$840/CY; adjusted to 2014 dollars
Elevated Slab	62	CY	\$1,155	\$71,610	Based on 2 ft slab or wall; \$1155/CY; adjusted to 2014 dollars.
Chlorine Contact Tanks					15 ft x 15 ft tank
Slab	17	CY	\$735	\$12,495	Based on 2 ft slab or wall; \$735/CY; adjusted to 2014 dollars.
Walls	35	CY	\$840	\$29,400	Based on 2 ft slab or wall; and 2 ft freeboard; \$840/CY; adjusted to 2014 dollars
Elevated Slab	17	CY	\$1,155	\$19,635	Based on 2 ft slab or wall; \$1155/CY; adjusted to 2014 dollars.
Rapid Mixing Tanks					15 ft x 15 ft tank
Slab	17	CY	\$735	\$12,495	Based on 2 ft slab or wall; \$735/CY; adjusted to 2014 dollars.
Walls	35	CY	\$840	\$29,400	Based on 2 ft slab or wall; and 2 ft freeboard; \$840/CY; adjusted to 2014 dollars
Elevated Slab	17	CY	\$1,155	\$19,635	Based on 2 ft slab or wall; \$1155/CY; adjusted to 2014 dollars.
Chemical Storage Containment	16	CY	\$1,313	\$21,000	Adjusted to 2014 dollars
Equipment Concrete Pads	77	CY	\$1,313	\$101,063	Adjusted to 2014 dollars
Subtotal (Installed Equipment Costs)				\$2,730,000	Rounded up to \$1000
General Requirements	7.5%			\$204,750	Division I requirements, including labor supervision, field offices, temporary utilities, health and safety, office supplies, clean up, photographs, survey, erosion control, coordination, testing services, and record documents
Earthwork	5%			\$136,500	Excavation, backfill, and fill required to construct project
Site Improvements	5%			\$136,500	Roadways, curb and gutter, sidewalk and landscaping
Valves, Piping, and Appurtenances	15%			\$410,000	Major system piping and valves
Electrical, Instrumentation and Controls	15%			\$410,000	PLC and SCADA equipment to control
Total Direct Costs				\$4,028,000	Rounded up to \$1000
Contractor's Overhead and Profit	20%			\$805,600	Includes bonds, mobilization and demobilization, insurance, overhead and profit, and management reserves
Construction Total				\$4,833,600	Rounded up to \$1000
Project Level Allowance (contingency)	20%			\$966,720	Budget item to cover change orders due to unforeseen conditions
Engineering, Legal and Administrative	20%			\$966,720	Includes permits, legal fees and engineering fees for design and construction
Project Total				\$6,768,000	Rounded up to \$1000
Low Estimate				\$4,738,000	-30%
High Estimate				\$10,152,000	+50%

LS – lump sum; EA – each; CY – cubic yard.
 Costs are in 2014 US dollars.
 Costs for land or easements are not included.

Table B.17
Estimated AACE Class 5 O&M costs for RCF systems with recycle

System Size (gpm)	Residuals Disposal	Chemicals	Labor	Filter Media Replacement	Maintenance and Spare Parts	Electricity	Lab and Field Analysis	Annual O&M (Rounded up to \$1,000)
100	\$42,800	\$11,200	\$169,000	\$600	\$8,400	\$1,700	\$34,000	\$268,000
500	\$213,900	\$48,800	\$245,000	\$2,600	\$15,600	\$6,600	\$47,200	\$580,000
2000	\$855,700	\$189,700	\$396,000	\$6,400	\$27,300	\$23,500	\$77,500	\$1,576,000

Costs are in 2014 US dollars.

Table B.18
Estimated AACE Class 5 capital costs for 100-gpm RCF system without recycle

Description	Quantity	Unit	Unit Cost	Total Cost	Notes
Equipment					
FeSO ₄ Feed System					
Storage Tank	1	EA	\$2,800	\$2,800	Quotes from Ryan Herco & Core-Rosion; 100 gal PE, outdoor, incl. seismic; adjusted to 2014 dollars
Metering Pumps	2	EA	\$3,200	\$6,400	Quotes from C.P. Crowley & HTP; 0.25 gph; 1 duty/ 1 stdby; adjusted to 2014 dollars
Static Mixers	1	EA	\$900	\$900	Quotes from Komax & EWS; 3-inch; adjusted to 2014 dollars
Reduction Tank					
Tank	1	EA	\$5,400	\$5,400	Quotes from Core-Rosion & Ryan Herco; 1,700 gal PE, outdoor, incl. seismic; adjusted to 2014 dollars
Mixer	1	EA	\$4,900	\$4,900	Quotes from Core-Rosion & EWS; G = 60 per second; adjusted to 2014 dollars
NaOCl Feed System					
Storage Tank	1	LS	\$600	\$600	Quote from Polyprocessing; 55 gal, HDPE, outdoor, incl. seismic, adjusted to 2014 dollars
Metering Pumps	2	EA	\$4,800	\$9,600	Quote from Prominent; 0.06 gph, 1 duty/ 1 stdby; adjusted to 2014 dollars
Static Mixers	1	EA	\$900	\$900	Quotes from Komax & EWS; 3-inch; adjusted to 2014 dollars.
Chlorine Contact Tank	1	EA	\$3,800	\$3,800	Quotes from Core-Rosion & Ryan Herco; 700 gal PE, outdoor, incl. seismic; adjusted to 2014 dollars
Polymer Mixing Tank					
Rapid Mixing Tank	1	EA	\$3,800	\$3,800	Quotes from Core-Rosion & Ryan Herco; 700 gal PE, outdoor, incl. seismic; adjusted to 2014 dollars
Mixer	1	EA	\$3,900	\$3,900	Quotes from Core-Rosion & EWS; G = 170 per second; adjusted to 2014 dollars
Filters					
Filter Equipment (Pressure Filters)	1	LS	\$294,000	\$294,000	Quotes from Coombs-Hopkins & Layne, including media; 3 gpm/sf, (2) 6.5 ft dia VPF, 1 duty/ 1 stdby; adjusted to 2014 dollars
Filter Drawdown Transfer Pump	2	EA	\$5,900	\$11,800	Quotes from DTI and Cortech; 55 gpm @ 70 ft; 1 duty/ 1 stdby; adjusted to 2014 dollars
Pumps					
Filter Feed Pumps (Progressive Cavity)	2	EA	\$13,000	\$26,000	Quotes from Cortech & Flow-Systems; 100 gpm @ 70 ft; 1 duty/ 1 stdby; adjusted to 2014 dollars
Polymer Feed Systems					
Polymer Feed System (Coagulant Aid)	1	LS	\$29,000	\$29,000	Quotes from Siemens & C.P. Crowley; adjusted to 2014 dollars
Polymer Feed System (Solids Settling Aid)	1	LS	\$11,000	\$11,000	Quotes from Siemens & C.P. Crowley; adjusted to 2014 dollars
Filtrate Tank for Backwash	1	EA	\$27,500	\$27,500	Quotes from Core-Rosion & Ryan Herco; 12,500 gal PE, outdoor, incl. seismic; adjusted to 2014 dollars
Backwash Pumps	2	EA	\$9,300	\$18,600	Quotes from ITT & Cortech; 600 gpm @ 50 ft; 1 duty/ 1stdby; adjusted to 2014 dollars
Backwash Waste Storage Tank	1	EA	\$36,050	\$36,050	Based on previous quotes for various tank sizes, estimated for 21,000 gal, adjusted to 2014 dollars
Sewer Discharge Pumps	2	EA	\$5,150	\$10,300	Quote based upon 175 gpm Hydromatic Submergible pump, 1 duty/ 1 stdby

(continued)

Table B.18 continued

Description	Quantity	Unit	Unit Cost	Total Cost	Notes
Subtotal				\$508,000	Rounded up to \$1000
Equipment Installation Cost	30%			\$153,000	Including tax, freight, installation and manufacturer services.
Chemical Storage Containment	2	CY	\$1,313	\$2,625	Adjusted to 2014 dollars
Equipment Concrete Pads	69	CY	\$1,313	\$90,563	Adjusted to 2014 dollars
Subtotal (Installed Equipment Costs)				\$755,000	Rounded up to \$1000
General Requirements	7.5%			\$56,625	Division I requirements, including labor supervision, field offices, temporary utilities, health and safety, office supplies, clean up, photographs, survey, erosion control, coordination, testing services, and record documents
Earthwork	5%			\$37,750	Excavation, backfill, and fill required to construct project
Site Improvements	5%			\$37,750	Roadways, curb and gutter, sidewalk and landscaping
Valves, Piping, and Appurtenances	15%			\$114,000	Major system piping and valves
Electrical, Instrumentation and Controls	15%			\$114,000	PLC and SCADA equipment to control
Total Direct Costs				\$1,115,000	Rounded up to \$1000
Contractor's Overhead and Profit	20%			\$223,000	Includes bonds, mobilization and demobilization, insurance, overhead and profit, and management reserves
Construction Total				\$1,338,000	Rounded up to \$1000
Project Level Allowance (contingency)	20%			\$267,600	Budget item to cover change orders due to unforeseen conditions
Engineering, Legal and Administrative	20%			\$267,600	Includes permits, legal fees and engineering fees for design and construction
Project Total				\$1,874,000	Rounded up to \$1000
Low Estimate				\$1,312,000	-30%
High Estimate				\$2,811,000	+50%

LS – lump sum; EA – each; CY – cubic yard.
 Costs are in 2014 US dollars.
 Costs for land or easements are not included.

Table B.19
Estimated AACE Class 5 capital costs for 500-gpm RCF system without recycle

Description	Quantity	Unit	Unit Cost	Total Cost	Notes
Equipment					
FeSO ₄ Feed System					
Storage Tank	1	EA	\$3,500	\$3,500	Quotes from Core-Rosion & Ryan Herco; 500 gal PE, outdoor, incl. seismic; adjusted to 2014 dollars.
Metering Pumps	2	EA	\$3,200	\$6,400	Quotes from C.P. Crowley & HTP; 1.3 gph; 1 duty/ 1 stdby; adjusted to 2014 dollars.
Static Mixers	1	EA	\$2,300	\$2,300	Quotes from Komax & EWS; 8-inch; adjusted to 2014 dollars.
Reduction Tank					
Tank	1	EA	\$21,000	\$21,000	Quotes from Core-Rosion & Ryan Herco; 8,000 gal PE, outdoor, incl. seismic; adjusted to 2014 dollars.
Mixer	1	EA	\$9,200	\$9,200	Quotes from Core-Rosion & EWS; G = 60 per second; adjusted to 2014 dollars.
NaOCl Feed System					
Storage Tank	1	EA	\$1,000	\$1,000	Quote from Polyprocessing; 115 gal, HDPE, outdoor, incl. seismic; adjusted to 2014 dollars.
Metering Pumps	2	EA	\$4,800	\$9,600	Quote from Prominent; 0.30 gph, 1 duty/ 1 stdby; adjusted to 2014 dollars.
Static Mixers	1	EA	\$2,300	\$2,300	Quotes from Komax & EWS; 8-inch; adjusted to 2014 dollars.
Chlorine Contact Tank	1	EA	\$7,100	\$7,100	Quotes from Core-Rosion & Ryan Herco; 3000 gal PE, outdoor, incl. seismic; adjusted to 2014 dollars.
Polymer Mixing Tank					
Rapid Mixing Tank	1	EA	\$7,100	\$7,100	Quotes from Core-Rosion & Ryan Herco; 3000 gal PE, outdoor, incl. seismic; adjusted to 2014 dollars.
Mixers	1	EA	\$4,600	\$4,600	Quotes from Core-Rosion & EWS; G = 170 per second; adjusted to 2014 dollars.
Filters					
Filter Equipment (Pressure Filters)	1	LS	\$489,000	\$489,000	Quotes from Coombs-Hopkins & Layne, including media; 3 gpm/sf; Coombs-Hopkins filters, 10' x 24' (4 cells, 3 duty/ 1 stdby); Layne filters, (2) 8" x 22', 1 duty/ 1 stdby; adjusted to 2014 dollars.
Filter Drawdown Transfer Pump	2	EA	\$5,000	\$10,000	Quotes from ITT and Cortech; 150 gpm @ 70 ft; 1 duty/ 1 stdby; adjusted to 2014 dollars.
Pumps					
Filter Feed Pumps (Progressive Cavity)	2	EA	\$40,000	\$80,000	Quotes from Cortech & Flow-Systems; 500 gpm @ 70 ft; 1 duty/ 1 stdby; adjusted to 2014 dollars.
Polymer Feed Systems					
Polymer Feed Systems (Coagulant Aid)	1	LS	\$11,000	\$11,000	Quotes from Siemens & C.P. Crowley; adjusted to 2014 dollars.
Polymer Feed Systems (Solids Settling Aid)	1	LS	\$11,900	\$11,900	Quotes from Siemens & C.P. Crowley; adjusted to 2014 dollars.
Filtrate Tank for Backwash	1	EA	\$42,000	\$42,000	Quotes from Superior; 22,000 gal; 15 ft dia x 16 ft height; adjusted to 2014 dollars.
Backwash Pumps	2	EA	\$15,100	\$30,200	Quotes from ITT & Cortech; 1,050 gpm @ 50 ft; 1 duty/ 1stdby; adjusted to 2014 dollars.
Backwash Waste Storage Tank	1	EA	\$72,100	\$72,100	Based on previous quotes for various tank sizes, estimated for 85,000 gal, adjusted to 2014 dollars
Sewer Discharge Pumps	2	EA	\$5,150	\$10,300	Quote based upon 175 gpm Hydromatic Submersible pump, 1 duty/ 1 stdby

(continued)

Table B.19 continued

Description	Quantity	Unit	Unit Cost	Total Cost	Notes
Subtotal				\$831,000	Rounded up to \$1000
Equipment Installation Cost	30%			\$250,000	Including tax, freight, installation and manufacturer services.
Chemical Storage Containment	6	CY	\$1,313	\$7,875	Adjusted to 2014 dollars
Equipment Concrete Pads	166	CY	\$1,313	\$217,875	Adjusted to 2014 dollars
Subtotal (Installed Equipment Costs)				\$1,307,000	Rounded up to \$1000
General Requirements	7.5%			\$98,025	Division 1 requirements, including labor supervision, field offices, temporary utilities, health and safety, office supplies, clean up, photographs, survey, erosion control, coordination, testing services, and record documents
Earthwork	5%			\$65,350	Excavation, backfill, and fill required to construct project
Site Improvements	5%			\$65,350	Roadways, curb and gutter, sidewalk and landscaping
Valves, Piping, and Appurtenances	15%			\$197,000	Major system piping and valves
Electrical, Instrumentation and Controls	15%			\$197,000	PLC and SCADA equipment to control
Total Direct Costs				\$1,930,000	Rounded up to \$1000
Contractor's Overhead and Profit	20%			\$386,000	Includes bonds, mobilization and demobilization, insurance, overhead and profit, and management reserves
Construction Total				\$2,316,000	Rounded up to \$1000
Project Level Allowance (contingency)	20%			\$463,200	Budget item to cover change orders due to unforeseen conditions
Engineering, Legal and Administrative	20%			\$463,200	Includes permits, legal fees and engineering fees for design and construction
Project Total				\$3,243,000	Rounded up to \$1000
Low Estimate				\$2,270,000	-30%
High Estimate				\$4,865,000	+50%

LS – lump sum; EA – each; CY – cubic yard.
 Costs are in 2014 US dollars.
 Costs for land or easements are not included.

Table B.20
Estimated AACE Class 5 capital costs for 2000-gpm RCF system without recycle

Description	Quantity	Unit	Unit Cost	Total Cost	Notes
Equipment					
FeSO ₄ Feed System					
Storage Tank	1	EA	\$6,200	\$6,200	Quotes from Core-Rosion & Ryan Herco; 2,000 gal PE, outdoor, incl. seismic; adjusted to 2014 dollars
Metering Pumps	2	EA	\$6,300	\$12,600	Quotes from C.P. Crowley & HTP; 5 gph; adjusted to 2014 dollars
Static Mixers	1	EA	\$4,400	\$4,400	Quotes from Komax & EWS; 14-inch; adjusted to 2014 dollars
Reduction Tank					
Mixers	1	EA	\$24,700	\$24,700	Quotes from Core-Rosion & EWS; G = 60 per second; adjusted to 2014 dollars
NaOCl Feed System					
Storage Tank	1	LS	\$2,400	\$2,400	Quote from Polyprocessing; 475 gal, HDPE, outdoor, incl. seismic; adjusted to 2014 dollars
Metering Pumps	2	EA	\$4,800	\$9,600	Quote from Prominent; 1.22 gph, 1 duty/ 1 stdby; adjusted to 2014 dollars
Static Mixers	1	EA	\$4,400	\$4,400	Quotes from Komax & EWS; 14-inch; adjusted to 2014 dollars.
Polymer Mixing Tanks					
Mixers	1	EA	\$17,900	\$17,900	Quotes from Core-Rosion & EWS; G = 170 per second; adjusted to 2014 dollars
Filters					
Filter Equipment (Pressure Filters)	1	LS	\$1,033,000	\$1,033,000	Quotes from Tonka & Layne, including media; 3 gpm/sf; Tonka filters, (2) 10' x 42', 4 cells per filter, 3 duty / 1 stdby; Layne filters, (4) 10' x 24', 3 duty/ 1 stdby; adjusted to 2014 dollars
Filter Drawdown Transfer Pump	2	EA	\$5,300	\$10,600	Quotes from ITT and Cortech; 150 gpm @ 70 ft; 1 duty/ 1 stdby; adjusted to 2012 dollars
Pumps					
Filter Feed Pumps (Progressive Cavity)	3	EA	\$57,000	\$171,000	Quotes from Cortech & Flow-Systems; 1,000 gpm @ 70 ft; 2 duty/ 1 stdby; adjusted to 2014 dollars
Polymer Feed Systems					
Polymer Feed Systems (Coagulant Aid)	1	LS	\$11,000	\$11,000	Quotes from Siemens & C.P. Crowley; adjusted to 2014 dollars
Polymer Feed Systems (Solids Settling Aid)	1	LS	\$11,900	\$11,900	Quotes from Siemens & C.P. Crowley; adjusted to 2014 dollars
Filtrate Tank for Backwash	1	EA	\$52,500	\$52,500	Quotes from Superior; 30,250 gal; 18 ft dia x 16 ft height; adjusted to 2014 dollars
Backwash Pumps	2	EA	\$22,500	\$45,000	Quotes from ITT & Cortech; 1,450 gpm @ 50 ft; 1 duty/ 1stdby; adjusted to 2014 dollars
Backwash Waste Storage Tank	1	EA	\$173,040	\$173,040	Based on previous quotes for various tank sizes, estimated for 286,000 gal, adjusted to 2014 dollars
Sewer Discharge Pumps	2	EA	\$5,150	\$10,300	Quote based upon 175 gpm Hydromatic Submersible pump, 1 duty/ 1 stdby

(continued)

Table B.20 continued

Description	Quantity	Unit	Unit Cost	Total Cost	Notes
Subtotal				\$1,601,000	Rounded up to \$1000
Equipment Installation Cost (30% of Equipment)	30%			\$481,000	Including tax, freight, installation and manufacturer services.
Reduction Tanks					
Slab	62	CY	\$735	\$45,570	Based on 2 ft slab or wall; \$735/CY; adjusted to 2014 dollars.
Walls	63	CY	\$840	\$52,920	Based on 2 ft slab or wall; and 2 ft freeboard; \$840/CY; adjusted to 2014 dollars
Elevated Slab	62	CY	\$1,155	\$71,610	Based on 2 ft slab or wall; \$1155/CY; adjusted to 2014 dollars.
Chlorine Contact Tanks					15 ft x 15 ft tank
Slab	17	CY	\$735	\$12,495	Based on 2 ft slab or wall; \$735/CY; adjusted to 2014 dollars.
Walls	35	CY	\$840	\$29,400	Based on 2 ft slab or wall; and 2 ft freeboard; \$840/CY; adjusted to 2014 dollars
Elevated Slab	17	CY	\$1,155	\$19,635	Based on 2 ft slab or wall; \$1155/CY; adjusted to 2014 dollars.
Rapid Mixing Tanks					15 ft x 15 ft tank
Slab	17	CY	\$735	\$12,495	Based on 2 ft slab or wall; \$735/CY; adjusted to 2014 dollars.
Walls	35	CY	\$840	\$29,400	Based on 2 ft slab or wall; and 2 ft freeboard; \$840/CY; adjusted to 2014 dollars
Elevated Slab	17	CY	\$1,155	\$19,635	Based on 2 ft slab or wall; \$1155/CY; adjusted to 2014 dollars.
Chemical Storage Containment	16	CY	\$1,313	\$21,000	\$1313/CY, adjusted to 2014 dollars
Equipment Concrete Pads	77	CY	\$1,313	\$101,063	\$1313/CY, adjusted to 2014 dollars
Subtotal (Installed Equipment Costs)				\$2,498,000	Rounded up to \$1000
General Requirements	7.5%			\$187,350	Division 1 requirements, including labor supervision, field offices, temporary utilities, health and safety, office supplies, clean up, photographs, survey, erosion control, coordination, testing services, and record documents
Earthwork	5%			\$124,900	Excavation, backfill, and fill required to construct project
Site Improvements	5%			\$124,900	Roadways, curb and gutter, sidewalk and landscaping
Valves, Piping, and Appurtenances	15%			\$375,000	Major system piping and valves
Electrical, Instrumentation and Controls	15%			\$375,000	PLC and SCADA equipment to control
Total Direct Costs				\$3,685,000	Rounded up to \$1000
Contractor's Overhead and Profit	20%			\$737,000	Includes bonds, mobilization and demobilization, insurance, overhead and profit, and management reserves
Construction Total				\$4,422,000	Rounded up to \$1000
Project Level Allowance (contingency)	20%			\$884,400	Budget item to cover change orders due to unforeseen conditions
Engineering, Legal and Administrative	20%			\$884,400	Includes permits, legal fees and engineering fees for design and construction
Project Total				\$6,191,000	Rounded up to \$1000
Low Estimate				\$4,334,000	-30%
High Estimate				\$9,287,000	+50%

LS – lump sum; EA – each; CY – cubic yard.
 Costs are in 2014 US dollars.
 Costs for land or easements are not included.

Table B.21
Estimated AACE Class 5 O&M costs for RCF systems without recycle

System Size (gpm)	Residuals Disposal	Chemicals	Labor	Filter Media Replacement	Maintenance and Spare Parts	Electricity	Lab and Field Analysis †	Annual O&M (Rounded up to \$1,000)
100	\$10,400	\$11,200	\$169,000	\$600	\$7,600	\$1,700	\$18,700	\$219,000
500	\$37,000	\$48,800	\$245,000	\$2,600	\$13,100	\$6,300	\$27,700	\$381,000
2000	\$136,600	\$189,700	\$396,000	\$6,400	\$25,000	\$22,500	\$53,900	\$830,000

Costs are in 2014 US dollars.