



CITY OF GLENDALE, CA

DESIGN REVIEW STAFF REPORT – SINGLE FAMILY

September 27, 2021 <i>Choose an item. Date</i>	1622 Ard Eevin Avenue <i>Address</i>
Administrative Design Review (ADR) <i>Review Type</i>	5629-017-015 <i>APN</i>
PDR2108777 <i>Case Number</i>	Kelly Sutherlin McLeod, FAIA <i>Applicant</i>
Cassandra Pruet, AICP <i>Case Planner</i>	Douglas & Devon Keegan <i>Owner</i>

Project Summary

The applicant is proposing to add a 428 square-foot (SF), two-story addition at the rear of an existing 2,150 SF, two-story single-family dwelling (originally constructed in 1926), located on an approximately 8,646 SF lot in the R1-I HD Zone (Residential, Floor Area Ratio District I, Historic District Overlay Zone). Of the 428 SF addition, 335 SF is located on the first floor and 93 SF on the second floor, with a 198 SF second-floor deck on top of the first-floor addition.

Environmental Review

The project is exempt from CEQA review as a Class 1 "Existing Facilities" exemption pursuant to Section 15301 of the State CEQA Guidelines because the project involves an addition that will not result in an increase of more than 50% of the floor area of the structure before the addition, or 2,500 square feet (SF). The project is also exempt from CEQA review as a Class 31 "Historic Restoration or Rehabilitation" exemption pursuant to Section 15331 of the State CEQA Guidelines because the project meets the Secretary of the Interior's Standards for Rehabilitation and the Historic District Design Guidelines.

Existing Property/Background

The project site is an approximately 8,646 SF, interior lot in the Ard Eevin Highlands Historic District. The site is relatively flat and is developed with a two-story, 2,150 SF single-family home with a detached two-car garage.

Staff Recommendation

Approve with Conditions

Last Date Reviewed / Decision

First time submittal for final review.

Zone: RI FAR District: I

Although this design review does not convey final zoning approval, the project has been reviewed for consistency with the applicable Codes and no inconsistencies have been identified.

Active/Pending Permits and Approvals

Administrative Exception Case Number PAE2104358 was approved on August 18, 2021 to allow continuation of the existing 4'-1 1/2" interior setback instead of the required 5' setback.

Site Slope and Grading

None proposed.

Neighborhood Survey

	Average of Properties within 300 linear feet of subject property	Range of Properties within 300 linear feet of subject property	Subject Property Proposal
Lot size	9,002 SF	6,579 SF - 12,076 SF	8,646 SF
Setback	33'	25' - 41'	35'
House size	2,334 SF	1,604 SF - 4,794 SF	2,578 SF
Floor Area Ratio	0.25	0.16 - 0.40	0.30
Number of stories	1.4 (15 one-story, 9 two-story)	1 to 2 stories	2 stories

DESIGN ANALYSIS**Site Planning**

Are the following items satisfactory and compatible with the project site and surrounding area?

Building Location

yes **n/a** **no**

If "no" select from below and explain:

- Setbacks of buildings on site
- Prevailing setbacks on the street
- Building and decks follow topography

Garage Location and Driveway

yes **n/a** **no**

If "no" select from below and explain:

- Predominant pattern on block
- Compatible with primary structure

- Permeable paving material
- Decorative paving

Landscape Design

- yes** **n/a** **no**

If “no” select from below and explain:

- Complementary to building design
- Maintains existing trees when possible
- Maximizes permeable surfaces
- Appropriately sized and located

Walls and Fences

- yes** **n/a** **no**

If “no” select from below and explain:

- Appropriate style/color/material
- Perimeter walls treated at both sides
- Retaining walls minimized
- Appropriately sized and located

Determination of Compatibility: Site Planning

The proposed site planning is appropriate, as modified by any proposed conditions, to the site and its surroundings for the following reasons:

- The two-story addition and second-floor deck are located at the rear of the house, minimally expanding the existing building footprint by approximately 25 feet by 12 feet, continuing the existing approximately 4' interior setback, and preserving ample landscaping and open space in the back yard.
- The addition and deck are minimally visible from the street.

Massing and Scale

Are the following items satisfactory and compatible with the project site and surrounding area?

Building Relates to its Surrounding Context

- yes** **n/a** **no**

If “no” select from below and explain:

- Appropriate proportions and transitions
- Relates to predominant pattern
- Impact of larger building minimized

Building Relates to Existing Topography

yes **n/a** **no**

If “no” select from below and explain:

- Form and profile follow topography
- Alteration of existing land form minimized
- Retaining walls terrace with slope

Consistent Architectural Concept

yes **n/a** **no**

If “no” select from below and explain:

- Concept governs massing and height

Scale and Proportion

yes **n/a** **no**

If “no” select from below and explain:

- Scale and proportion fit context
- Articulation avoids overbearing forms
- Appropriate solid/void relationships
- Entry and major features well located
- Avoids sense of monumentality

Roof Forms

yes **n/a** **no**

If “no” select from below and explain:

- Roof reinforces design concept
- Configuration appropriate to context

Determination of Compatibility: Mass and Scale

The proposed massing and scale are appropriate, as modified by any proposed conditions, to the site and its surroundings for the following reasons:

- The two-story addition and second-floor deck are located at the rear of the house and are only somewhat visible from the street at the south façade.
- The addition continues the existing building height (24'-3"), roof lines, and wall facades in order to preserve the existing style of the house.
- The massing of the house is extended slightly toward the rear, south-west corner, with only 93 SF being added on the second floor, thereby not significantly impacting the overall massing.
- The 2nd floor addition partially screens the 2nd floor deck/balcony from the neighbors to the south.

Design and Detailing

Are the following items satisfactory and compatible with the project site and surrounding area?

Overall Design and Detailing

yes **n/a** **no**

If “no” select from below and explain:

- Consistent architectural concept
- Proportions appropriate to project and surrounding neighborhood
- Appropriate solid/void relationships

Entryway

yes **n/a** **no**

If “no” select from below and explain:

- Well integrated into design
- Avoids sense of monumentality
- Design provides appropriate focal point
- Doors appropriate to design

Windows

yes **n/a** **no**

If “no” select from below and explain:

- Appropriate to overall design
- Placement appropriate to style
- Recessed in wall, when appropriate

Privacy

yes **n/a** **no**

If “no” select from below and explain:

- Consideration of views from “public” rooms and balconies/decks
- Avoid windows facing adjacent windows

Finish Materials and Color

yes **n/a** **no**

If “no” select from below and explain:

- Textures and colors reinforce design
- High-quality, especially facing the street
- Respect articulation and façade hierarchy
- Wrap corners and terminate appropriately

Paving Materials

yes **n/a** **no**

If “no” select from below and explain:

- Decorative material at entries/driveways
- Permeable paving when possible
- Material and color related to design

Lighting, Equipment, Trash, and Drainage

yes **n/a** **no**

If “no” select from below and explain:

- Light fixtures appropriately located/avoid spillover and over-lit facades
- Light fixture design appropriate to project
- Equipment screened and well located
- Trash storage out of public view
- Downspouts appropriately located
- Vents, utility connections integrated with design, avoid primary facades

Ancillary Structures

yes **n/a** **no**

If “no” select from below and explain:

- Design consistent with primary structure
- Design and materials of gates complement primary structure

Determination of Compatibility: Design and Detailing

The proposed design and detailing are appropriate, as modified by any proposed conditions, to the site and its surroundings for the following reasons:

- The two-story addition and second-floor deck are well-integrated into the existing architectural style of the house because they use the same materials and stylistic elements, including siding, roofing, railing, and wood windows. All new materials will match existing and the deck railing has been design in a pattern to match the front entrance railing.
- A vertical reglet is added at the joint between the existing house and the addition to represent the transition point between the two eras of construction.
- The first floor addition involves removal of one window and reduction in size of a second window at the south-facing façade, which would reduce potential privacy impact to the neighbor. The proposed new window has been carefully designed to maintain the architectural features of the existing window.
- The second-story addition contains no windows, which prevents any related privacy issue in that area.

Recommendation / Draft Record of Decision

Based on the above analysis, staff recommends **Approval with Conditions**. This determination is based on the implementation of the following recommended conditions:

Conditions

1. Project shall demonstrate compliance with all conditions of approval in the related Administrative Exception case (Case Number PAE2104358, approved on August 18, 2021).
-

Attachments

1. Reduced Plans
2. Photos of Existing Property
3. Location Map
4. Neighborhood Survey
5. Decision letter for PAE2014358

Keegan Residence

Addition and Remodel To Existing Residence and Garage

New ADU

1622 Ard Eevin Avenue,
Glendale, CA 91202

ABBREVIATIONS	SYMBOLS	PROJECT DESCRIPTION	SHEET INDEX																																																				
<p>AB. ANCHOR BOLT ABV. ABOVE APPROX. APPROXIMATELY ARCH. ARCHITECT BD. BOARD BLDG. BUILDING BLK. BLOCK BLN. BELOW B.O. BOTTOM OF BYD. BEYOND CAB. CABINET C.B. CATCH BASIN C.J. CEILING JOIST CL. CENTER LINE CLR. CLEAR CLG. CEILING COL. COLUMN CONC. CONCRETE CONST. CONSTRUCTION CONT./CONTIN. CONTINUOUS CER. CERAMIC DEMO. DEMOLITION DET./ DTL. DETAIL D.F. DOUGLAS FIR DIA./ DIAM. DIAMETER DIM. DIMENSION DN. DOWN D.S. DOWNSPOUT DWS. DRAINING EA. EACH ELEC. ELECTRICAL ELEV. ELEVATION EQ. EQUAL EX./(E)/EXISTG. EXISTING EQUIP. EQUIPMENT EXT./ EXTR. EXTERIOR F.F. FINISH FLOOR F.G. FIBERGLASS FIN. FINISH FLR. FLOOR F.P. FIRE PROOF FLUOR. FLUORESCENT F.O.S. FACE OF STUD F.H. FIRE HYDRANT FTG. FOOTING G.C. GENERAL CONTRACTOR GA. GAUGE GALV. GALVANIZED GL./ GLS. GLASS GYP. GYPSUM</p> <p>HDN. HARDWARE H.T. HEIGHT H.M. HOLLOW METAL HR. HOUR H.W.H. HOT WATER HEATER IN. INCHES INSUL. INSULATION INT./INTR. INTERIOR JST. JOIST JNT. JOINT LAM. LAMINATED MFR. MANUFACTURER MAT. MATERIAL MAX. MAXIMUM MIN. MINIMUM MISC. MISCELLANEOUS MECH. MECHANICAL MET. / MTL. METAL N. I. C. NOT IN CONTRACT PART. PARTITION PLAS. PLASTER PL. PLATE P.W. PLYWOOD R. RADIUS R.D. ROOF DRAIN R.R. ROOF RAFTER REINF. REINFORCEMENT REQD. REQUIRED RETAIN'G./ RET'G. RETAINING REV. REVISION REC. RECOMMENDATION SEC. SECTION SIM. SIMILAR SHT. SHEET SPECS. SPECIFICATIONS S.S. STAINLESS STEEL STL. STEEL STRUC.T. STRUCTURAL SUSP. SUSPENDED TEL. TELEPHONE TEMP. TEMPORARY THK. THICKNESS T.O. TOP OF TYP. TYPICAL U.G. UNDERGROUND VER. VERIFY W / ARCHITECT VERT.L. VERTICAL V.G. VERTICAL GRAIN N. / W. WITH W.P. WATER PROOF</p>	<p>ELEVATION DRAWING NUMBER 2 5 N WALL REFERENCE NUMBER</p> <p>DETAIL DRAWING NUMBER 3 6 SHEET NUMBER</p> <p>ELEVATION DRAWING NUMBER 1 4 SHEET NUMBER</p> <p>DOOR NUMBER 2</p> <p>WINDOW NUMBER 3</p> <p>REVISION NUMBER 1</p> <p>NEW CONSTRUCTION</p> <p>EXISTING STRUCTURE TO REMAIN</p> <p>EXISTING STRUCTURE TO BE DEMOLISHED</p> <p>DIMENSIONS — FACE OF FINISH — FACE OF STUD</p> <p>FIRE SPRINKLER FIRE SPRINKLER NO SPRINKLER</p> <p>AREA CALCULATIONS</p> <table style="width: 100%; border-collapse: collapse;"> <tr> <td>1- LOT SIZE:</td> <td style="text-align: right;">± 8,646 S.F.</td> </tr> <tr> <td>2- MAX LOT COVERAGE</td> <td style="text-align: right;">.40 X 8,646 S.F. ± 3,458 S.F.</td> </tr> <tr> <td>3- MAX BUILDING AREA (FAR):</td> <td style="text-align: right;">(.30 X 8,646 S.F.) + 500 SQ.FT. (GARAGE) ± 3,094 S.F.</td> </tr> <tr> <td colspan="2">EXISTING RESIDENCE:</td> </tr> <tr> <td>4- EXISTING LIVING:</td> <td style="text-align: right;">2,150 S.F.</td> </tr> <tr> <td> A. FIRST FLOOR</td> <td style="text-align: right;">1,150 S.F.</td> </tr> <tr> <td> B. SECOND FLOOR</td> <td style="text-align: right;">1,000 S.F.</td> </tr> <tr> <td>5- DETACHED GARAGE:</td> <td style="text-align: right;">1,077 S.F.</td> </tr> <tr> <td> A. GARAGE (24'-6 1/2" X 20'-4 1/2")</td> <td style="text-align: right;">500 S.F.</td> </tr> <tr> <td> B. GAME ROOM</td> <td style="text-align: right;">394 S.F.</td> </tr> <tr> <td> C. STORAGE</td> <td style="text-align: right;">283 S.F.</td> </tr> <tr> <td>6- (E) TOTAL LIVING 4 + 5</td> <td style="text-align: right;">3,227 S.F.</td> </tr> <tr> <td>7- (E) FOOTPRINT: 4A + 5</td> <td style="text-align: right;">2,227 S.F.</td> </tr> <tr> <td>8- (E) LOT COVERAGE: 7/1</td> <td style="text-align: right;">26% < 40% OK</td> </tr> <tr> <td>9- (E) BUILDING AREA (FAR): 6 - 500 (GARAGE) / 1</td> <td style="text-align: right;">32% > 30% NO</td> </tr> <tr> <td colspan="2">PROPOSED RESIDENCE:</td> </tr> <tr> <td>9- (N) ADDITION LIVING -</td> <td style="text-align: right;">428 S.F.</td> </tr> <tr> <td> A. FIRST FLOOR</td> <td style="text-align: right;">338 S.F.</td> </tr> <tr> <td> B. SECOND FLOOR</td> <td style="text-align: right;">93 S.F.</td> </tr> <tr> <td>10- REMOVAL OF GAME ROOM AND STORAGE</td> <td style="text-align: right;">577 S.F.</td> </tr> <tr> <td>11 - ACCESSORY DWELLING UNIT (MAX 800 S.F.)</td> <td style="text-align: right;">684 S.F.</td> </tr> <tr> <td>12- (N) TOTAL LIVING: 6 - 10 + 9</td> <td style="text-align: right;">3,078 S.F.</td> </tr> <tr> <td>13- (N) FOOTPRINT: 7 - 10 + 9A</td> <td style="text-align: right;">1,985 S.F.</td> </tr> <tr> <td>14- (N) LOT COVERAGE: 13/1</td> <td style="text-align: right;">23% < 40% OK</td> </tr> <tr> <td>15- (N) BUILDING AREA (FAR): 12 - 500 (GARAGE) / 1</td> <td style="text-align: right;">30% = 30% OK</td> </tr> <tr> <td>16- (N) BUILDING AREA (FAR) WITH ADU: 12 + 11 - 500 (GARAGE) / 1</td> <td style="text-align: right;">38%</td> </tr> </table>	1- LOT SIZE:	± 8,646 S.F.	2- MAX LOT COVERAGE	.40 X 8,646 S.F. ± 3,458 S.F.	3- MAX BUILDING AREA (FAR):	(.30 X 8,646 S.F.) + 500 SQ.FT. (GARAGE) ± 3,094 S.F.	EXISTING RESIDENCE:		4- EXISTING LIVING:	2,150 S.F.	A. FIRST FLOOR	1,150 S.F.	B. SECOND FLOOR	1,000 S.F.	5- DETACHED GARAGE:	1,077 S.F.	A. GARAGE (24'-6 1/2" X 20'-4 1/2")	500 S.F.	B. GAME ROOM	394 S.F.	C. STORAGE	283 S.F.	6- (E) TOTAL LIVING 4 + 5	3,227 S.F.	7- (E) FOOTPRINT: 4A + 5	2,227 S.F.	8- (E) LOT COVERAGE: 7/1	26% < 40% OK	9- (E) BUILDING AREA (FAR): 6 - 500 (GARAGE) / 1	32% > 30% NO	PROPOSED RESIDENCE:		9- (N) ADDITION LIVING -	428 S.F.	A. FIRST FLOOR	338 S.F.	B. SECOND FLOOR	93 S.F.	10- REMOVAL OF GAME ROOM AND STORAGE	577 S.F.	11 - ACCESSORY DWELLING UNIT (MAX 800 S.F.)	684 S.F.	12- (N) TOTAL LIVING: 6 - 10 + 9	3,078 S.F.	13- (N) FOOTPRINT: 7 - 10 + 9A	1,985 S.F.	14- (N) LOT COVERAGE: 13/1	23% < 40% OK	15- (N) BUILDING AREA (FAR): 12 - 500 (GARAGE) / 1	30% = 30% OK	16- (N) BUILDING AREA (FAR) WITH ADU: 12 + 11 - 500 (GARAGE) / 1	38%	<p>- 428 SQ. FT. ADDITION TO AN EXISTING 2,150 SQ. FT. TWO STORY SINGLE FAMILY RESIDENCE, WITH A 198 SQ. FT. SECOND FLOOR DECK. PROJECT SCOPE INCLUDES REMOVAL OF 577 SQ. FT. ADDITION AT BACK OF EXISTING DETACHED GARAGE. A NEW 684 SQ. FT. ADU AT THE REAR OF THE PROPERTY</p> <p>- PROPERTY IS A CONTRIBUTOR TO THE ARD EEVIN HIGHLANDS HISTORIC DISTRICT LOCATED IN GLENDALE, CA. THEREFORE IN ADDITION TO ALL OTHER REQUIREMENTS, ALL WORK OF THIS CONTRACT SHALL BE PERFORMED UNDER THE GUIDELINES OF THE SECRETARY OF INTERIORS' STANDARDS FOR THE TREATMENT OF HISTORIC PROPERTIES.</p> <p>PROJECT TEAM</p> <p>PROJECT ARCHITECT KELLY SUTHERLIN MCLEOD ARCHITECTURE, INC. 3827 LONG BEACH BOULEVARD LONG BEACH, CALIFORNIA, 90807 CONTACT: KELLY SUTHERLIN MCLEOD, FAIA TEL: (562) 427-6697 FAX (562) 427-0527</p> <p>STRUCTURAL ENGINEER NOUS ENGINEERING, INC. 600 WHILSHIRE BLVD, SUITE 760 LOS ANGELES, CA 90017 CONTACT: ELIZABETH MAHLOW, PE TEL: (213) 627-6687</p> <p>CIVIL ENGINEER WABER CONSULTANTS 3711 LONG BEACH BLVD, STE. 100B LONG BEACH, CA 90807 CONTACT: MAHIR WABER TEL: (562) 426-8283 FAX: (562) 312-3282</p> <p>SURVEYOR M & M & CO. LAND SURVEYORS 16145 ROSCOE BLVD. NORTH HILLS, CA 91343 CONTACT: ELISABETH BRIONES TEL: (818) 891-9100 FAX: (818) 891-9115</p> <p>GEOTECHNICAL ENGINEER SUBSURFACE DESIGN, INC. 12848 FOOTHILL BLVD. SYLMAR, CA 91342 CONTACT: JOHN MAHN, PE. TEL: (818) 898-1545 FAX: (818) 898-4003</p>	<p>ARCHITECTURAL</p> <p>A-0.0 TITLE AND PROJECT INFORMATION A-0.1 ARCHITECTURAL SURVEY A-1.0 DISMANTLE SITE PLAN A-1.1 PROPOSED SITE PLAN A-1.2 NEIGHBORING PROPERTIES SITE PLAN A-1.3 PROPOSED LANDSCAPE CALCULATIONS A-2.0 HOUSE FIRST AND SECOND FLOOR - DISMANTLE PLAN A-3.0 HOUSE FIRST AND SECOND FLOOR - PROPOSED PLAN A-3.1 HOUSE ROOF PLAN - PROPOSED AND EXISTING A-3.2 GARAGE PROPOSED AND DISMANTLE FLOOR AND ROOF PLAN A-3.3 NEW ADU FLOOR AND ROOF PLAN - PROPOSED A-4.0 HOUSE EXTERIOR ELEVATIONS - EXISTING & PROPOSED A-4.1 HOUSE EXTERIOR ELEVATIONS - EXISTING & PROPOSED A-4.2 GARAGE EXTERIOR ELEVATIONS - EXISTING & PROPOSED A-4.3 GARAGE EXTERIOR ELEVATIONS - EXISTING & PROPOSED A-4.4 NEW ADU EXTERIOR ELEVATIONS A-4.5 HOUSE RENDERED PERSPECTIVES A-4.6 HOUSE RENDERED PERSPECTIVES A-5.0 HOUSE BUILDING SECTIONS A-5.1 NEW ADU BUILDING SECTIONS A-7.0 HOUSE AND NEW ADU DOOR SCHEDULE A-7.1 HOUSE AND NEW ADU WINDOW SCHEDULE A-8.0 DETAILS A-8.1 DETAILS</p> <p>CONSTRUCTION WASTE REDUCTION NOTE</p> <p>NOTE: CONSTRUCTION WASTE MANAGEMENT - REDUCE CONSTRUCTION WASTE BY RECYCLING OR SALVAGING FOR RE-USE A MINIMUM OF 65 PERCENT OF THE NON HAZARDOUS CONSTRUCTION AND DEMOLITION WASTE IN ACCORDANCE WITH SECTION 4.408.2.4.08.B OR MEET THE LOCAL CITY OF GLENDALE CONSTRUCTION AND DEMOLITION WASTE REDUCTION AND RECYCLING PLAN, ORDINANCE No. 5895 WHICHEVER IS MORE STRINGENT.</p> <p>VICINITY MAP</p>
1- LOT SIZE:	± 8,646 S.F.																																																						
2- MAX LOT COVERAGE	.40 X 8,646 S.F. ± 3,458 S.F.																																																						
3- MAX BUILDING AREA (FAR):	(.30 X 8,646 S.F.) + 500 SQ.FT. (GARAGE) ± 3,094 S.F.																																																						
EXISTING RESIDENCE:																																																							
4- EXISTING LIVING:	2,150 S.F.																																																						
A. FIRST FLOOR	1,150 S.F.																																																						
B. SECOND FLOOR	1,000 S.F.																																																						
5- DETACHED GARAGE:	1,077 S.F.																																																						
A. GARAGE (24'-6 1/2" X 20'-4 1/2")	500 S.F.																																																						
B. GAME ROOM	394 S.F.																																																						
C. STORAGE	283 S.F.																																																						
6- (E) TOTAL LIVING 4 + 5	3,227 S.F.																																																						
7- (E) FOOTPRINT: 4A + 5	2,227 S.F.																																																						
8- (E) LOT COVERAGE: 7/1	26% < 40% OK																																																						
9- (E) BUILDING AREA (FAR): 6 - 500 (GARAGE) / 1	32% > 30% NO																																																						
PROPOSED RESIDENCE:																																																							
9- (N) ADDITION LIVING -	428 S.F.																																																						
A. FIRST FLOOR	338 S.F.																																																						
B. SECOND FLOOR	93 S.F.																																																						
10- REMOVAL OF GAME ROOM AND STORAGE	577 S.F.																																																						
11 - ACCESSORY DWELLING UNIT (MAX 800 S.F.)	684 S.F.																																																						
12- (N) TOTAL LIVING: 6 - 10 + 9	3,078 S.F.																																																						
13- (N) FOOTPRINT: 7 - 10 + 9A	1,985 S.F.																																																						
14- (N) LOT COVERAGE: 13/1	23% < 40% OK																																																						
15- (N) BUILDING AREA (FAR): 12 - 500 (GARAGE) / 1	30% = 30% OK																																																						
16- (N) BUILDING AREA (FAR) WITH ADU: 12 + 11 - 500 (GARAGE) / 1	38%																																																						
<p>ON AND AFTER JANUARY 1, 2014, IT IS NOW REQUIRED BY CALIFORNIA LAW FOR ALL BUILDING ALTERATIONS OR IMPROVEMENTS TO SINGLE-FAMILY RESIDENTIAL REAL PROPERTY, AS DEFINED, THAT WATER-CONSERVING PLUMBING FIXTURES REPLACE OTHER NONCOMPLIANT PLUMBING FIXTURES AS A CONDITION FOR ISSUANCE OF A CERTIFICATE OF FINAL COMPLETION AND OCCUPANCY OR FINAL PERMIT APPROVAL BY THE LOCAL BUILDING DEPARTMENT.</p>																																																							
<p>PERMITS / CITY REVIEWS</p>																																																							
<p>CODES</p> <p>ALL WORK TO COMPLY TO THE FOLLOWING APPLICABLE CODES:</p> <p>2019 CALIFORNIA RESIDENTIAL CODE (CRC) 2019 CALIFORNIA MECHANICAL CODE (CMC) 2019 CALIFORNIA ELECTRICAL CODE (CEC) 2019 CALIFORNIA PLUMBING CODE (CPC) 2019 CALIFORNIA FIRE CODE 2019 CALIFORNIA ENERGY CODE (CEC) 2019 CALIFORNIA GREEN BUILDING STANDARDS CODE 2019 CALIFORNIA HISTORICAL BUILDING CODE (CHBC) 2017 GLENDALE'S BUILDING STANDARDS CODE (GBSC) 2019 CALIFORNIA BUILDING CODE (CBC)</p> <p>ALL PORTIONS OF NEW CONSTRUCTION SHALL COMPLY WITH REQUIREMENTS OF CURRENT CODES AND REGULATIONS AS AMENDED BY THE CITY OF GLENDALE</p>																																																							
		<p>LEGAL DESCRIPTION</p> <p>APN: 5629-017-015 LOT 5 OF TRACT NO. 5861, CITY OF GLENDALE, COUNTY OF LOS ANGELES, STATE OF CALIFORNIA, AS PER MAP RECORDED IN BOOK 62 PAGE 95 OF MAPS IN THE OFFICE OF THE COUNTY RECORDER OF SAID COUNTY</p> <p>PROJECT INFORMATION</p> <p>PROJECT ADDRESS: 1622 ARD EEVIN AVENUE, GLENDALE, CA 91202</p> <p>L.A. COUNTY ASSESSOR'S ID NO.: APN 5629-017-015 ZONING: R11 HD HIGH FIRE HAZARD OCCUPANCY: R-3 SINGLE FAMILY RESIDENTIAL CONSTRUCTION TYPE: TYPE V-B: WOOD FRAME, NON-SPRINKLERED BUILDING HEIGHT/STORIES: +/- 24'-3 3/4" (EXISTING) & +/- 24'-3 3/4" (PROPOSED) / 2 STORY</p> <p>SOILS REPORT DATED: 12/02/2020 PREPARED BY: SUBSURFACE DESIGNS, INC</p>																																																					

DATE		SHEET REVISIONS			
DATE		SHEET REVISIONS			
<p>KELLY SUTHERLIN MCLEOD ARCHITECTURE, INC. 3827 Long Beach Blvd. Long Beach, CA 90807 562-427-6697 tel 562-427-0527 fax ksm@ksmarchitecture.com www.ksmarchitecture.com</p>					
<p>Title Sheet and Project Information</p>					
PROJECT ISSUES / SUBMITTALS	DATE				
PRE-APPLICATION REV.	1/25/20				
ADDITIONAL REV.	2/25/20				
ADDITIONAL REV.	03/04/21				
ADDITIONAL REV.	03/29/21				
ADDITIONAL REV.	04/27/21				
DESIGN REVIEW APP.	04/27/21				
<p>KEEGAN RESIDENCE 1622 Ard Eevin Avenue Glendale, Ca 91202</p>					
Date: 07/22/2021					
Draw: KSM ARCHITECTURE, INC.					
Job: -					
Sheet: A-0.0					

07/22/21 - Design Review Application

Architectural Survey

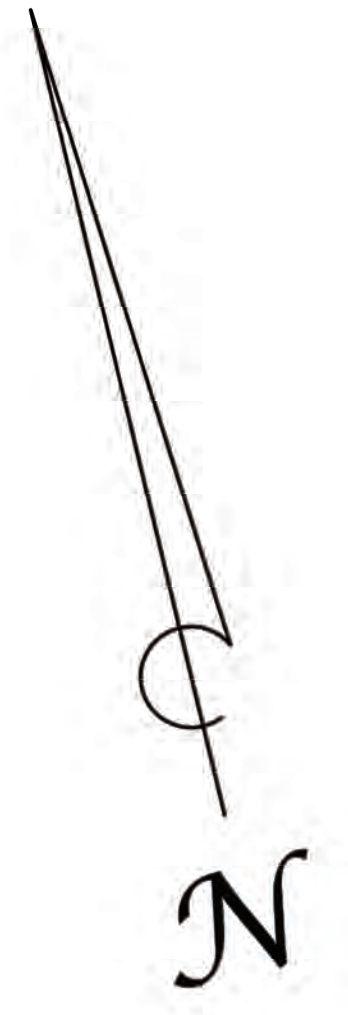
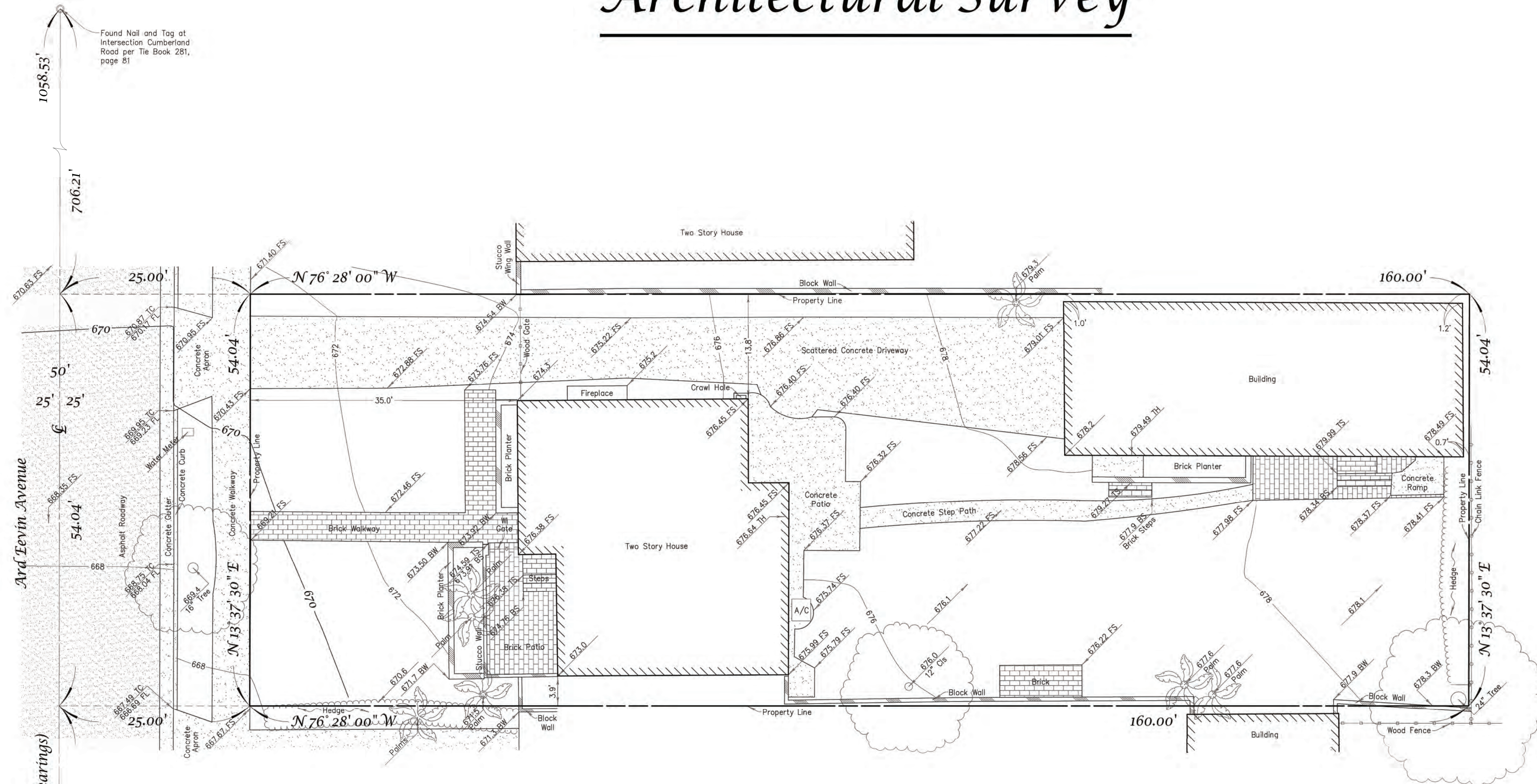

Scale: 1" = 8'

Legend

- TH = Threshold
- FF = Finished Floor
- FS = Finished Surface
- FL = Flowline
- CB = Catch Basin
- BW = Bottom of Wall
- TW = Top of Wall
- TC = Top of Curb
- TS = Top of Step
- BS = Bottom of Step
- GR = Ground
- WI = Wrought Iron
- A/C = Air Conditioner

Note: Hatch Patterns Are Not to Scale

LEGAL DESCRIPTION: LOT 5 OF TRACT NO. 5861, CITY OF GLENDALE, COUNTY OF LOS ANGELES, STATE OF CALIFORNIA, AS PER MAP RECORDED IN BOOK 62 PAGE 95 OF MAPS IN THE OFFICE OF THE COUNTY RECORDER OF SAID COUNTY.

APN: 5629-017-015

SITE ADDRESS: 1622 ARD EEVIN AVENUE, GLENDALE, CA 91202

AREA: 8,646 SQUARE FEET, 0.20 ACRES

BOUNDARY: THE PROPERTY LINES SHOWN HEREON ARE RECORD PER THE LEGAL DESCRIPTION AND RELATED DOCUMENTS, UNLESS OTHERWISE NOTED. THE PROPERTY LINES ARE ADJUSTED TO BEST FIT PER FOUND CITY CENTERLINE AND/OR SURVEY MONUMENTS, AND OCCUPATION.

BASIS OF BEARINGS: THE BEARING OF NORTH 13° 37' 30" EAST WAS USED ON THE CENTERLINE OF ARD EEVIN AVENUE PER TRACT NO. 5861 MAP BOOK 62 PAGE 95, AS SHOWN HEREON.

BENCH MARK: THE ELEVATION OF 714.54 ON SURVEY BENCHMARK BM2019 AS SHOWN ON CITY OF GLENDALE SURVEY BENCHMARKS WAS USED AS DATUM FOR THIS SURVEY.

DATE OF FIELD SURVEY: OCTOBER 27, 2020

Plan Prepared For: Douglas and Devon Keegan
1622 Ard Eevin Avenue
Glendale, CA 91202

Plan Prepared By: M & M & Co.
26074 Avenue Hall, Suite 12
Santa Clarita, CA 91355
(818) 891-9100
Gregory M. Amoroso, L.S. 8771



Sewer Manhole Monument at Intersection Glenview Driveway per Tie Book 2013, page 1

Found Nail and Tag at Intersection Cumberland Road per Tie Book 281, page 81

07/22/21 - Design Review Application

PROJECT / SUBMITTALS	DATE
PRE-APPLICATION	1/25/20
PRE-APPLICATION REV.	2/25/20
ADMINISTRATIVE	09/04/21
ADMINISTRATIVE REV. 1	03/29/21
ADMINISTRATIVE REV. 2	04/27/21
DESIGN REVIEW APP.	04/27/21

DATE	
SHEET REVISIONS	

KELLY SUTHERLIN McLEOD
ARCHITECTURE, INC.
3827 Long Beach Blvd. | Long Beach, CA 90807
562-427-6697 tel | 562-427-0527 fax
ksm@ksmarchitecture.com | www.ksmarchitecture.com

Architectural Survey

KEEGAN RESIDENCE
1622 Ard Eevin Avenue
Glendale, Ca 91202

Date: 07/22/2021
Drawn: KSM ARCHITECTURE, INC.
Job: -
Sheet: A-0.1

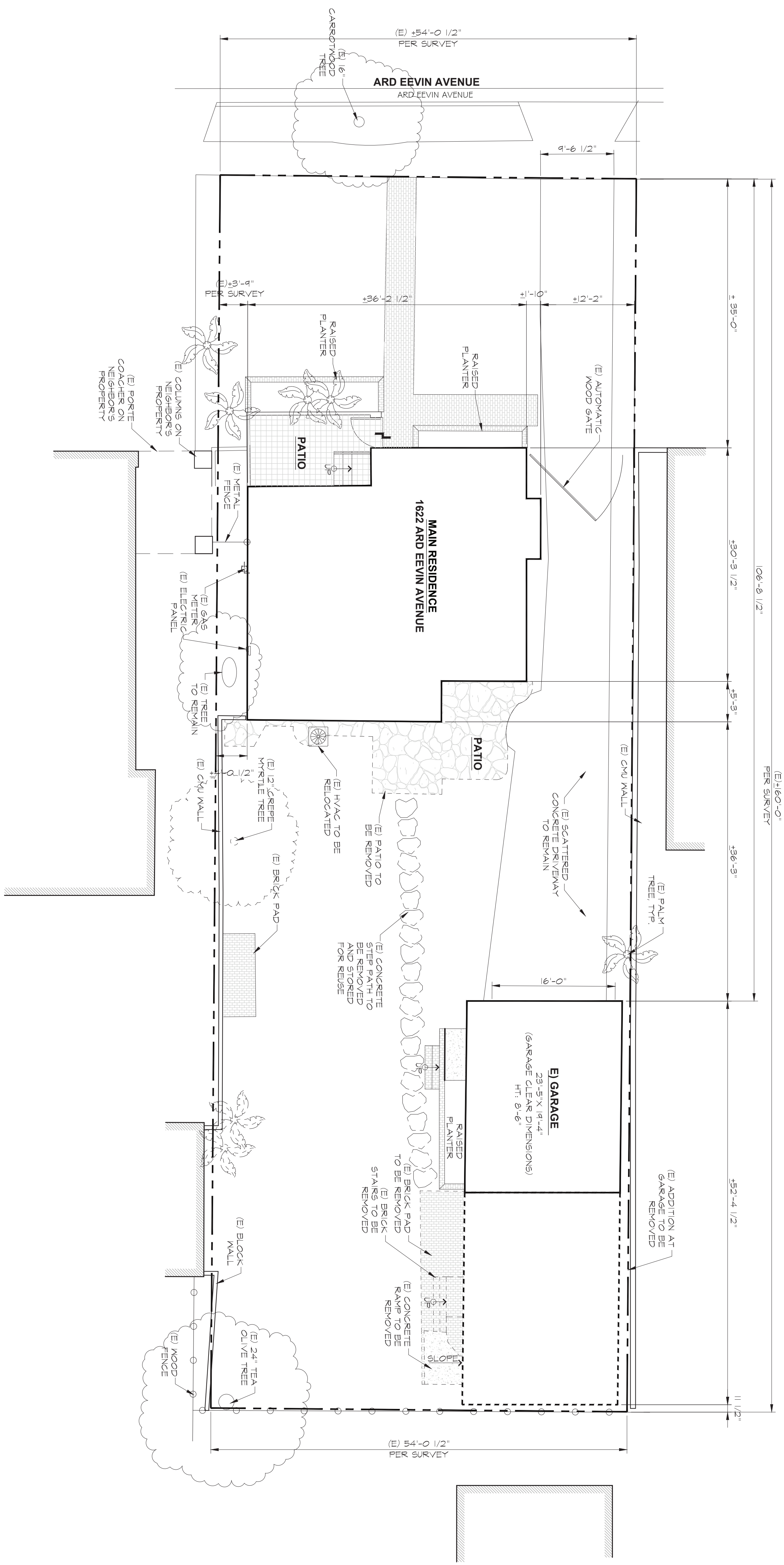

1 Demolition Site Plan

Scale: 1/8" = 1'-0"

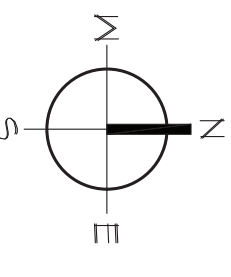

07/22/21 - Design Review Application

Sheet
A-1.0

KEEGAN RESIDENCE
1622 Ard Eevin Avenue
Glendale, Ca 91202

PROJECT ISSUES / SUBMITTALS	DATE
PRE-APPLICATION	1/25/20
PRE-APPLICATION REV.	2/23/20
ADMINISTRATIVE EXEMPTION APP.	03/04/21
ADMINISTRATIVE EXEMPTION APP. REV. 1	03/29/21
ADMINISTRATIVE EXEMPTION APP. REV. 2	04/27/21
DESIGN REVIEW APP.	04/27/21

Dismantle Site Plan

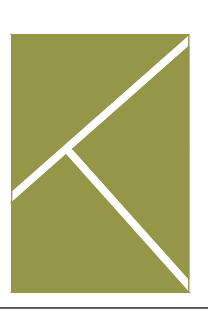

KELLY SUTHERLIN McLEOD
ARCHITECTURE, INC.
3827 Long Beach Blvd. | Long Beach, CA 90807
562.427.6697 tel | 562.427.0527 fax
ksm@ksmarchitecture.com | www.ksmarchitecture.com

SHEET REVISIONS	DATE

NOTES:
NO OAK, BAY, OR SYCAMORE TREES LOCATED ON OR WITHIN 20'-0" OF THE SUBJECT PROPERTY

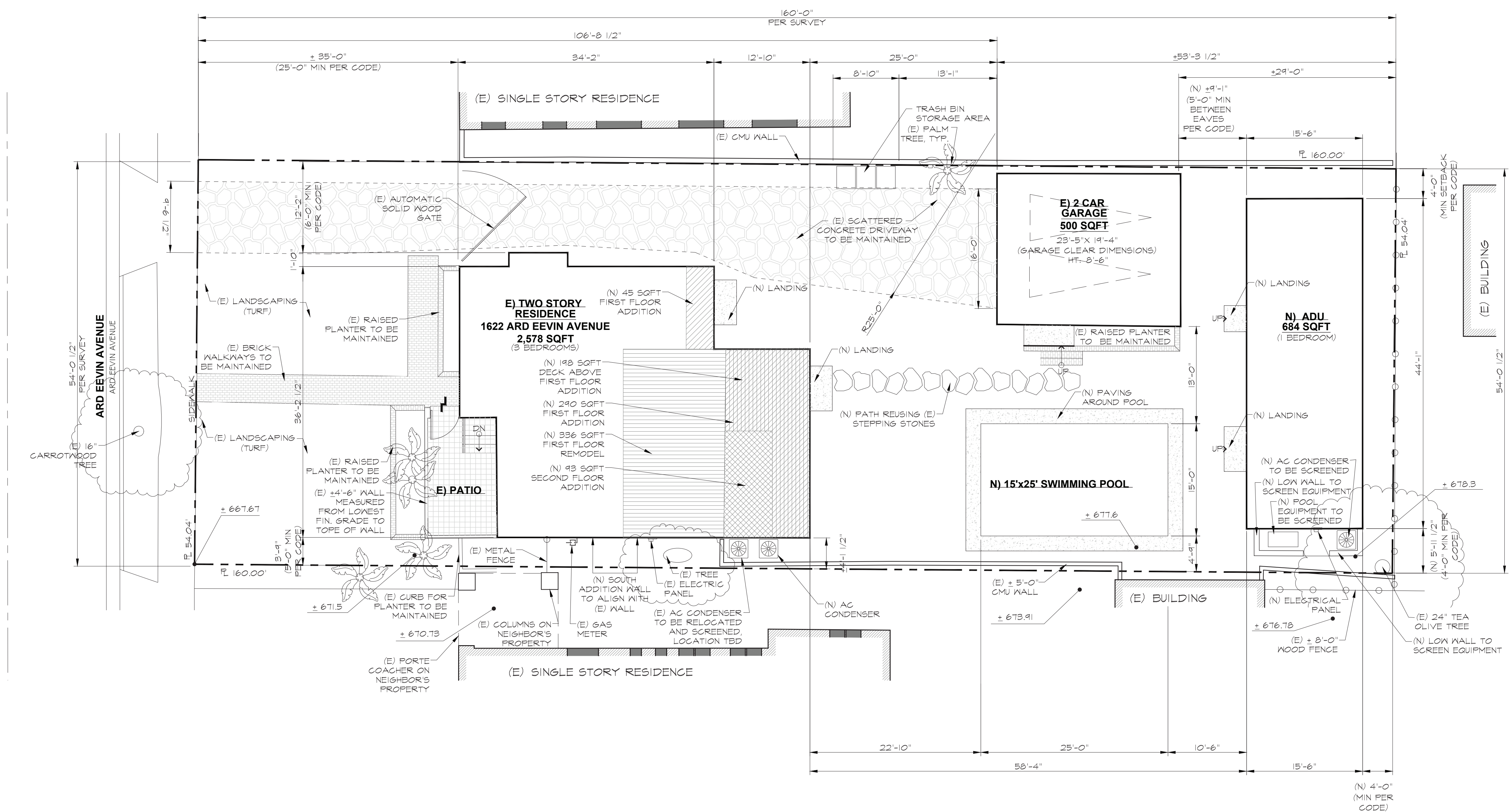

1 Plot Plan

Scale: 1/8" = 1'-0"

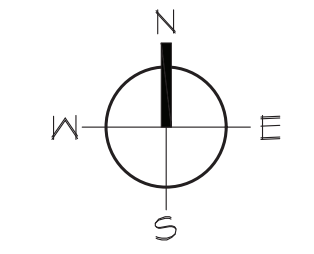

07/22/21 - Design Review Application

KEEGAN RESIDENCE
1622 Ard Evin Avenue
Glendale, Ca 91202

Date: 07/22/2021
Drawn: KSM ARCHITECTURE, INC.
Job:
Sheet:

A-1.1

PROJECT / SUBMITTALS	DATE
ISSUES / SUBMITTALS	1/25/20
PRE-APPLICATION REV.	2/23/20
ADMINISTRATIVE REV.	03/04/21
ADMINISTRATIVE REV. 1	03/24/21
ADMINISTRATIVE REV. 2	04/27/21
DESIGN REVIEW APP.	04/27/21

Proposed Site Plan

KELLY SUTHERLIN McLEOD
ARCHITECTURE, INC.
3827 Long Beach Blvd. | Long Beach, CA 90807
562-427-6697 tel | 562-427-0527 fax
ksm@ksmarchitecture.com | www.ksmarchitecture.com

SHEET REVISIONS	DATE

LEGEND

- EXTERIOR WALLS
- FIRST FLOOR WINDOWS
- SECOND FLOOR WINDOWS

UNLESS NOTED OTHERWISE WINDOWS ARE EXISTING, NEW WINDOWS NOTED

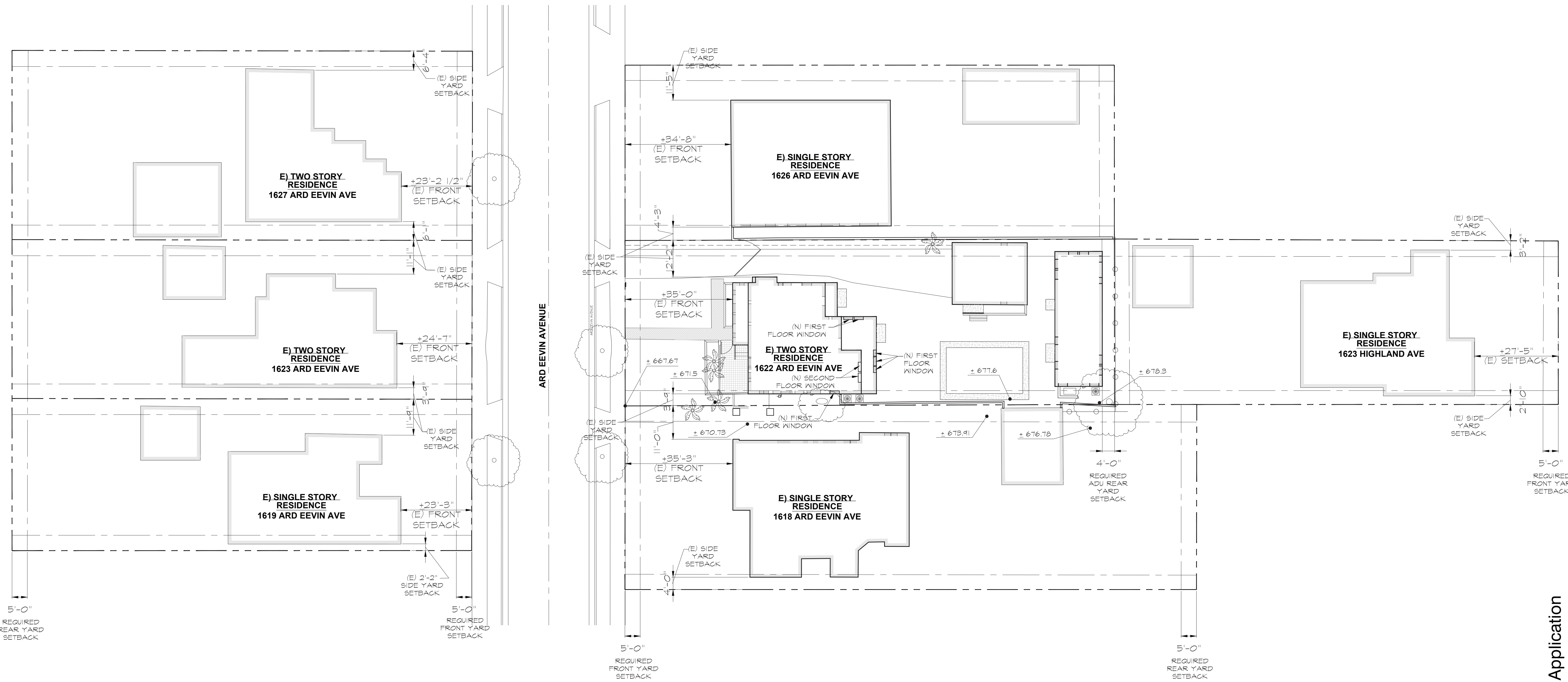

DATE	SHEET REVISIONS

KELLY SUTHERLIN McLEOD
 ARCHITECTURE, INC.
 3827 Long Beach Blvd. | Long Beach, CA 90807
 562-427-6697 tel | 562-427-0527 fax
 ksm@ksmarchitecture.com | www.ksmarchitecture.com

Neighboring Properties Site Plan

PROJECT ISSUES / SUBMITTALS	DATE	REQUIRED FRONT YARD SETBACK
PRE-APPLICATION	11/25/20	
PRE-APPLICATION REV.	12/23/20	
ADMINISTRATIVE	03/04/21	
ADMINISTRATIVE REV. 1	03/24/21	
ADMINISTRATIVE REV. 2	04/27/21	
EXECUTION APP. REV. 2	04/27/21	
DESIGN REVIEW APP.	04/27/21	

KEEGAN RESIDENCE
 1622 Ard Eevin Avenue
 Glendale, Ca 91202

Date: 07/22/2021
 Drawn: KSM ARCHITECTURE, INC.
 Job:
 Sheet:

A-1.2

07/22/21 - Design Review Application

1 Neighboring Properties Site Plan
 Scale: 1/16" = 1'-0"

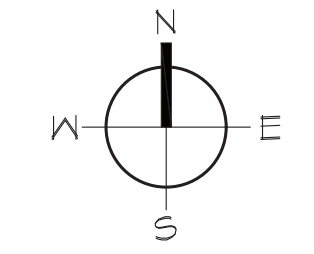

LANDSCAPE CALCULATIONS

FRONT YARD		
A	26'-2"	X 21'-5" = 560.40 SF
B	28'-2"	X 16'-3 3/8" = 458.54 SF
C	3'-10 1/2"	X 16'-6 1/2" = 64.10 SF
D	2'-2 1/2"	X 13'-3 1/2" = 29.35 SF
E	4'-0 1/2"	X 0'-8 1/2" = 2.86 SF
F	4'-5"	X 2'-4 1/4" = 22.17 SF
TOTAL		1187.47 SF
SOUTH SIDE YARD		
G	4'-1 1/2"	X 3'-1 1/8" = 32.74 SF
H	34'-4 1/2"	X 3'-11 1/4" = 135.35 SF
TOTAL		168.14 SF
NORTH SIDE YARD		
I	106'-8"	X 2'-1 3/4" = 228.89 SF
J	24'-6 1/2"	X 1'-1 1/8" = 26.84 SF
K	20'-2 1/2"	X 4'-0" = 80.83 SF
TOTAL		336.56 SF

REAR YARD			
L	20'-10 1/2"	X 20'-1 1/2" = 420.11 SF	
M	25'-0"	X 15'-0" = 375.00 SF	
N	8'-1 1/2"	X 2'-9" = 22.34 SF	
O	8'-6"	X 13'-5 1/4" = 114.23 SF	
P	5'-6"	X 6'-0" = 33.00 SF	
Q	8'-6"	X 10'-1 1/4" = 85.84 SF	
R	13'-5 7/8"	X 7'-8 1/2" = 103.46 SF	
S	21'-1 1/4"	X 23'-9 1/2" = 63.42 SF	
T	IRREGULAR SHAPE	426.0 SF	
U	13'-5 1/2"	X 2'-8" = 35.84 SF	
V	4'-0"	X 2'-7" = 23.25 SF	
W	5'-10"	X 3'-6" = 20.42 SF	
X	8'-10"	X 18'-5 1/8" = 162.77 SF	
Y	15'-6"	X 14'-4 1/4" = 21.45 SF	
Z	4'-0"	X 50'-1"	200.33 SF
TOTAL		2119.07 SF	

RATIO LANDSCAPED AREA TO LOT AREA:
 MINIMUM REQUIRED:
 (40% X LOT AREA) 40% x 8,646 SF = 3,458 SF
 3,761.24 SF / 8,646 SF = 43% = 44%

PROPOSED LANDSCAPED AREA TO LOT AREA:
 FRONT YARD: 1,187.47 SF
 SOUTH SIDE YARD: 168.14 SF
 NORTH SIDE YARD: 336.56 SF
 REAR YARD: 2,119.07 SF
 TOTAL: 3,761.24 SF

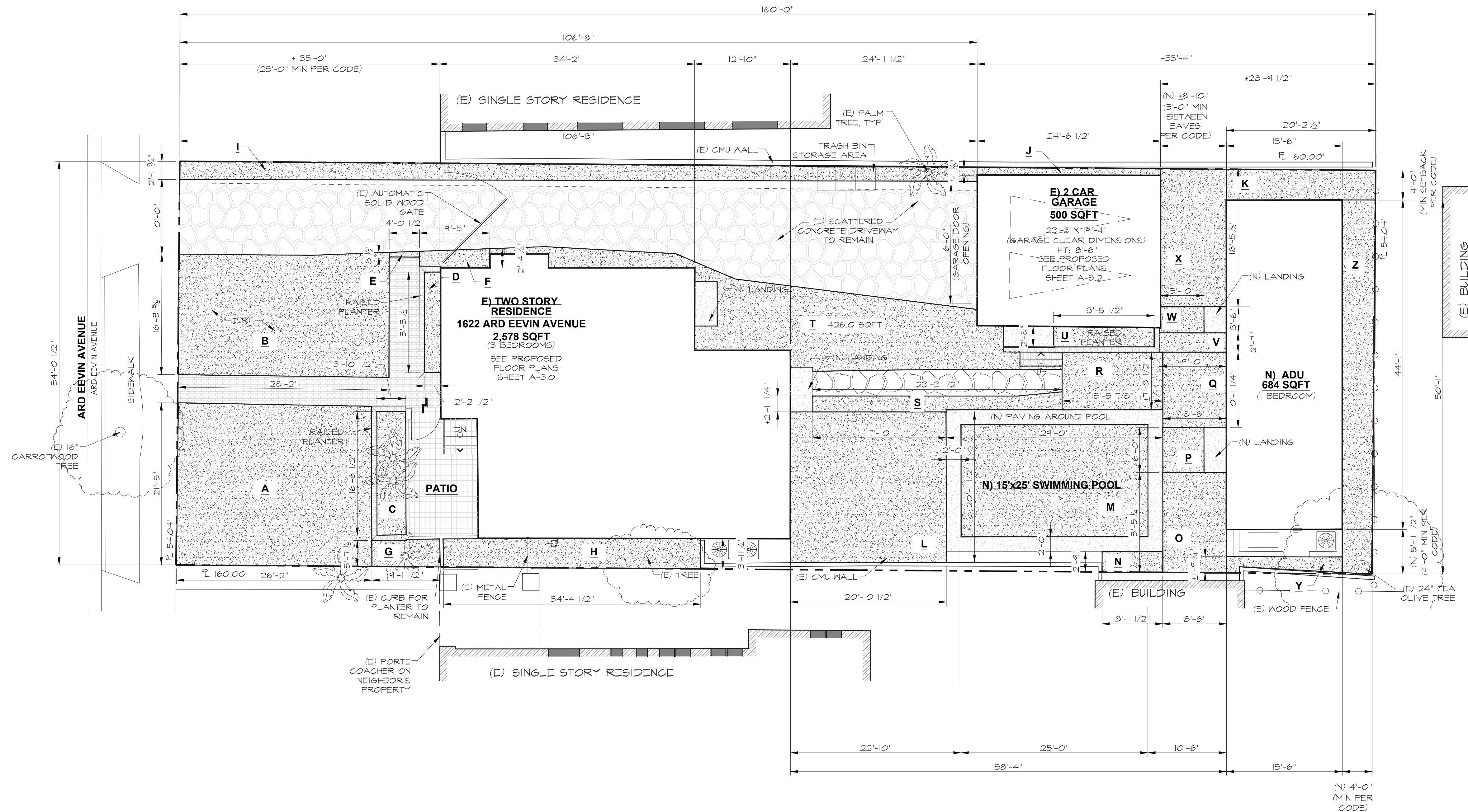

1 Proposed Site Plan Landscape Calculations
 Scale: 1/8" = 1'-0"

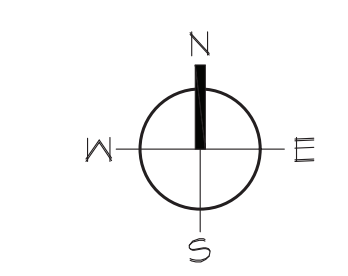

07/22/21 - Design Review Application

PROJECT / SUBMITTALS	DATE
ISSUES / SUBMITTALS	11/25/20
PRE-APPLICATION	12/23/20
ADMINISTRATIVE REV.	03/04/21
ADMINISTRATIVE REV. 1	03/24/21
ADMINISTRATIVE REV. 2	04/27/21
DESIGN REVIEW APP.	04/27/21

KEEGAN RESIDENCE
 1622 Ard Eevin Avenue
 Glendale, Ca 91202

Date: 07/22/2021
 Drawn: KSM ARCHITECTURE, INC.
 Job:
 Sheet: A-1.3

Proposed Landscape Calculations

KELLY SUTHERLIN McLEOD
 ARCHITECTURE, INC.
 3827 Long Beach Blvd. | Long Beach, CA 90807
 562-427-6697 tel | 562-427-0527 fax
 ksm@ksmarchitecture.com | www.ksmarchitecture.com

EXISTING RESIDENCE DEMOLITION CALCULATIONS	
TOTAL AREA OF (E) ROOF	1,462.6 SF
TOTAL AREA OF (E) EXTERIOR WALLS	2,802.6 SF
TOTAL (E) AREA	4,302.6 SF
(E) ROOF AREA TO BE DEMOLISHED	59.7 SF
(E) EXTERIOR WALL AREA TO BE DEMOLISHED	579.0 SF
TOTAL DEMOLISHED AREA	626.7 SF
TOTAL DEMOLISHED AREA DIVIDED BY TOTAL (E) AREA	626.7 / 4302.6 = 14.5% = 15%

LEGEND	
	NEW WALL
	EXISTING WALL TO REMAIN
	EXISTING STRUCTURE TO BE REMOVED
	FACE OF FINISH
	FACE OF STUD

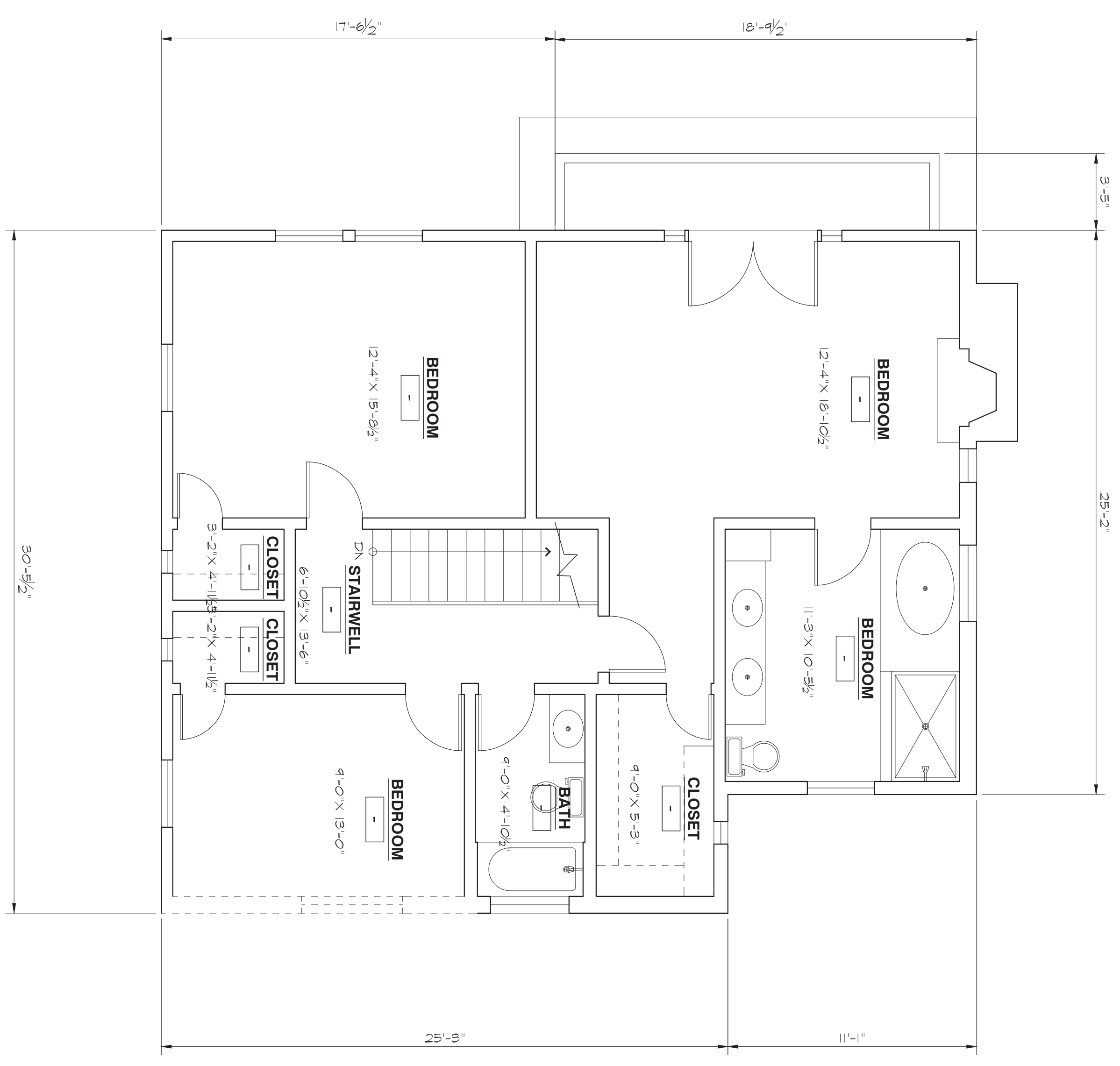

2 Demolition House Second Floor Plan

Scale: 1/4" = 1'-0"

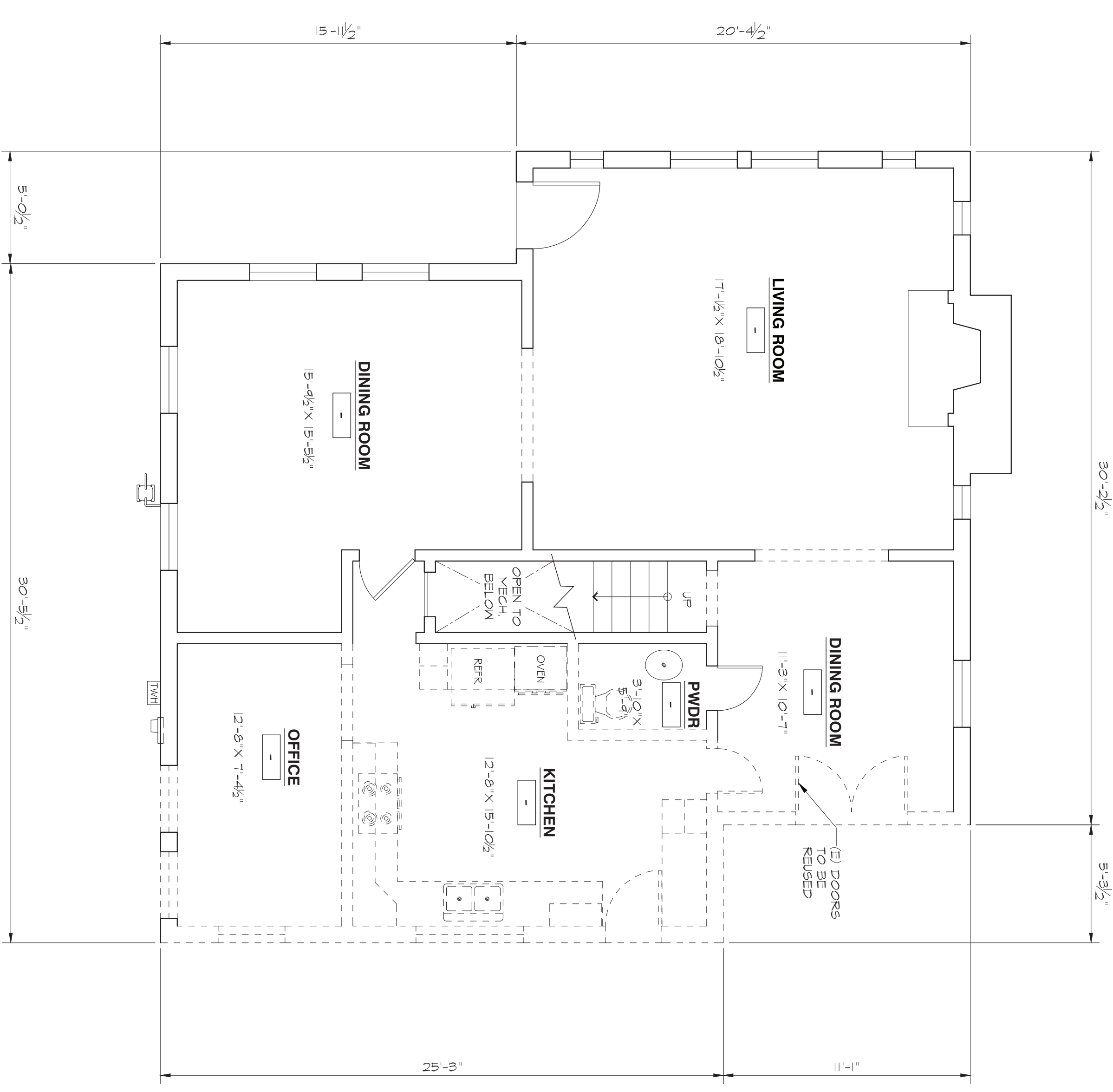

1 Demolition House First Floor Plan

Scale: 1/4" = 1'-0"

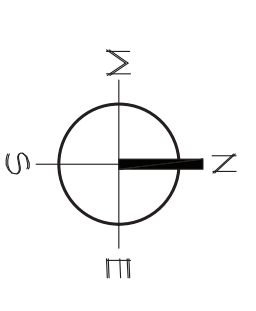

07/22/21 - Design Review Application

SHEET REVISIONS <table border="1"> <tr><th>NO.</th><th>DATE</th><th>DESCRIPTION</th></tr> <tr><td> </td><td> </td><td> </td></tr> <tr><td> </td><td> </td><td> </td></tr> <tr><td> </td><td> </td><td> </td></tr> <tr><td> </td><td> </td><td> </td></tr> </table>	NO.	DATE	DESCRIPTION													DATE 	House First and Second Floor Dismantle Plan	KELLY SUTHERLIN McLEOD ARCHITECTURE, INC. 3827 Long Beach Blvd. Long Beach, CA 90807 562.427.6697 tel 562.427.0527 fax ksm@ksmarchitecture.com www.ksmarchitecture.com	PROJECT ISSUES / SUBMITTALS PRE-APPLICATION PRE-APPLICATION REV. ADMINISTRATIVE EXEMPTION APP. ADMINISTRATIVE EXEMPTION APP. REV. 1 ADMINISTRATIVE EXEMPTION APP. REV. 2 DESIGN REVIEW APP.	DATE 1/25/20 2/23/20 03/04/21 03/24/21 04/27/21 04/27/21	1622 Ard Eevin Avenue Glendale, Ca 91202	Date: 07/22/2021 Drawn: KSM ARCHITECTURE, INC. Job: - Sheet: A-2.0
	NO.	DATE	DESCRIPTION																			
KEEGAN RESIDENCE 1622 Ard Eevin Avenue Glendale, Ca 91202	Date: 07/22/2021 Drawn: KSM ARCHITECTURE, INC. Job: - Sheet: A-2.0																					

NOTES
1. NO NEW ROOFTOP EQUIPMENT ALLOWED

LEGEND

	NEW WALL
	EXISTING WALL TO REMAIN
	EXISTING STRUCTURE TO BE REMOVED
DIMENSIONS	
	FACE OF FINISH
	FACE OF STUD

DATE	SHEET/REVISIONS

KELLY SUTHERLIN McLEOD
ARCHITECTURE, INC.
3827 Long Beach Blvd. | Long Beach, CA 90807
562-427-6697 tel | 562-427-0527 fax
ksm@ksmarchitecture.com | www.ksmarchitecture.com



House Roof Plan Proposed and Existing

PROJECT ISSUES / SUBMITTALS	DATE
PRE-APPLICATION	1/25/20
PRE-APPLICATION REV.	2/23/20
ADMINISTRATIVE	03/04/21
ADMINISTRATIVE	03/24/21
ADMINISTRATIVE REV. 1	04/27/21
EXCEPTION APP. REV. 2	04/27/21
DESIGN REVIEW APP.	04/27/21

KEEGAN RESIDENCE
1622 Ard Evin Avenue
Glendale, Ca 91202

Date: 07/22/2021
Drawn: KSM ARCHITECTURE, INC.
Job: -
Sheet: A-3.1

07/22/21 - Design Review Application

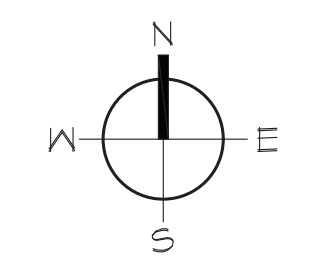
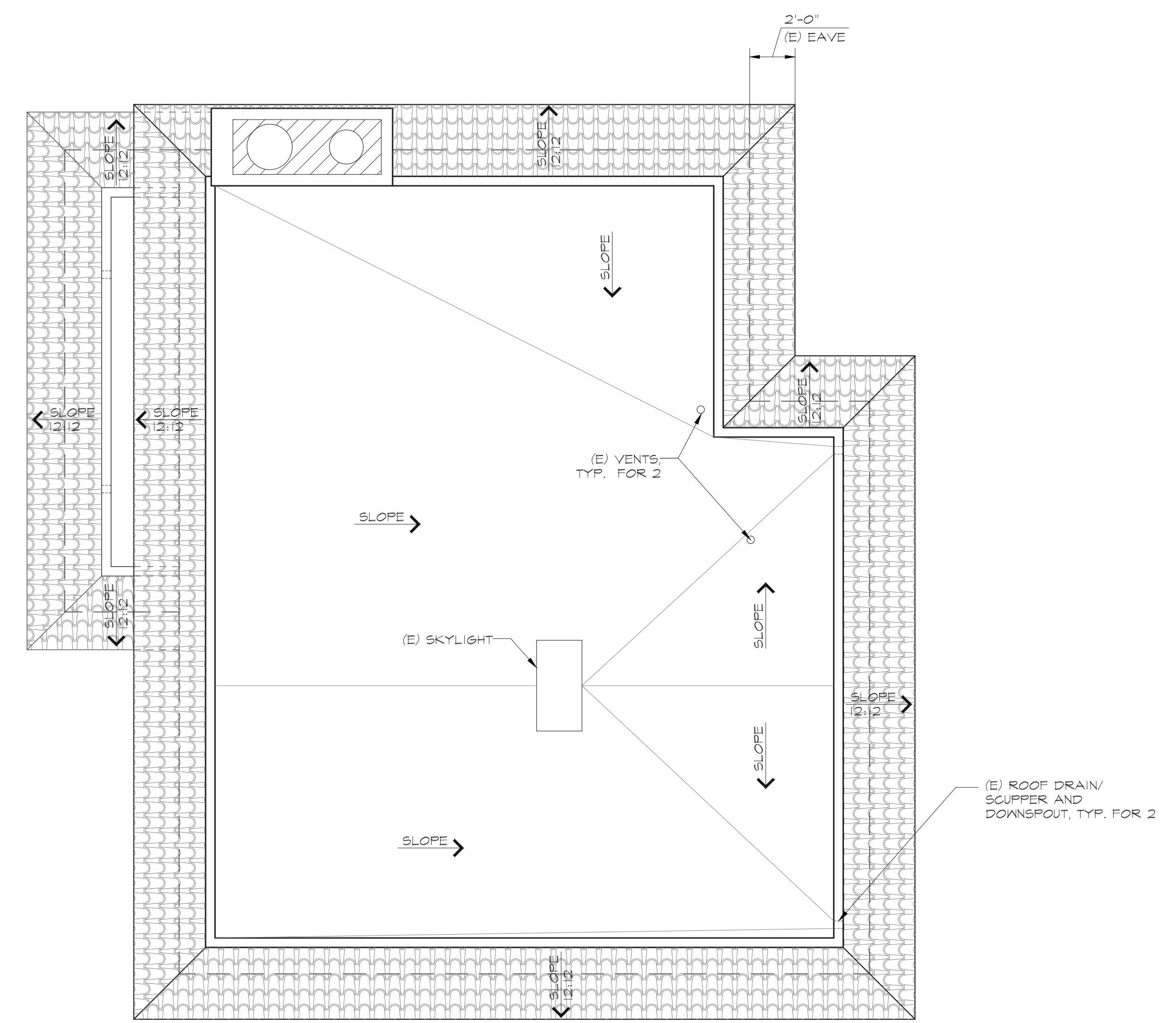
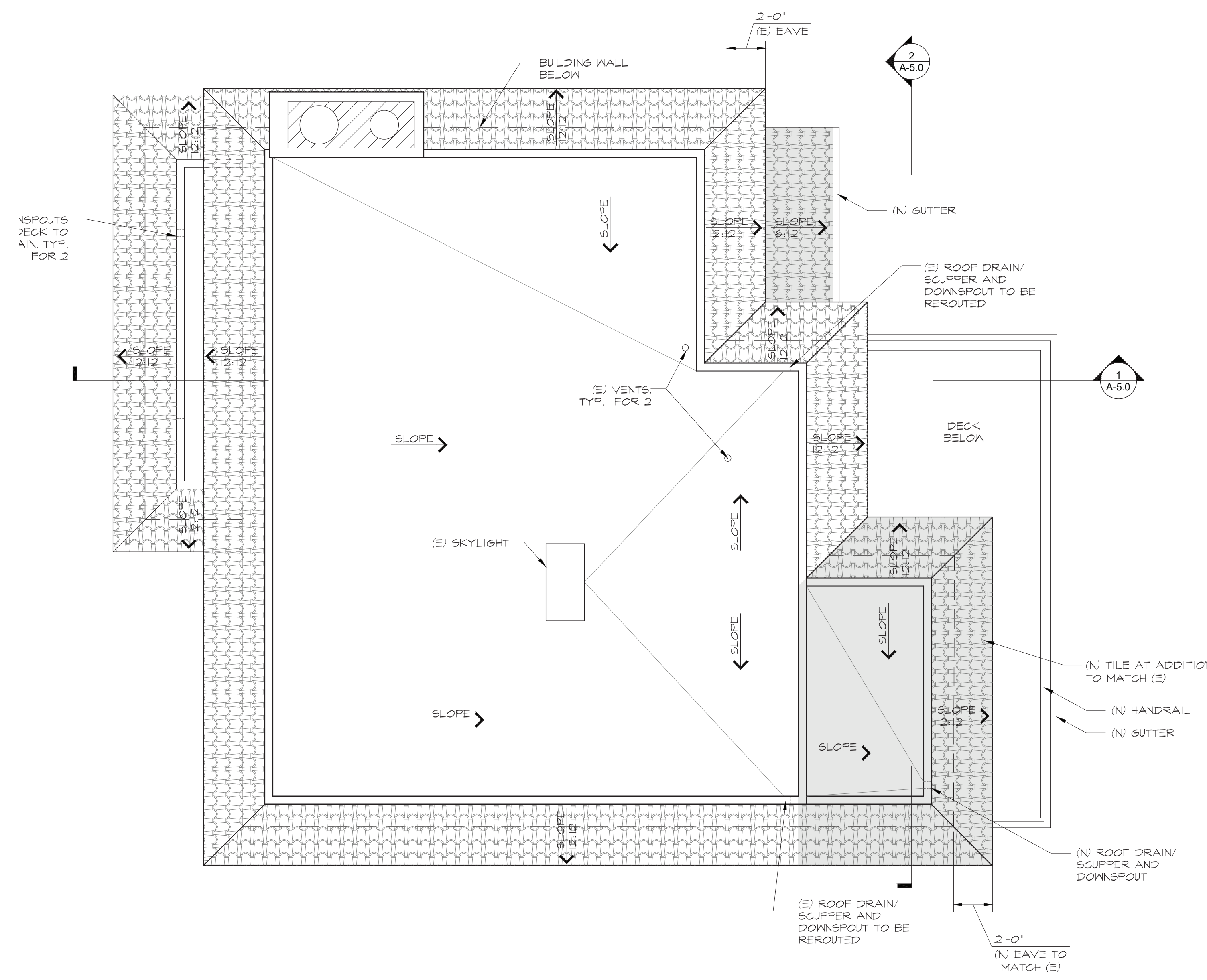

NOTES

1. NO NEW ROOFTOP EQUIPMENT ALLOWED

EXISTING GARAGE DEMOLITION CALCULATIONS	
TOTAL AREA OF (E) ROOF	1,228.8 SF
TOTAL AREA OF (E) EXTERIOR WALLS	1,626.2 SF
TOTAL (E) AREA	2,924.8 SF
(E) ROOF AREA TO BE DEMOLISHED	639.1 SF
(E) EXTERIOR WALL AREA TO BE DEMOLISHED	843.6 SF
TOTAL DEMOLISHED AREA	1,532.7 SF
TOTAL DEMOLISHED AREA DIVIDED BY TOTAL (E) AREA	
$1,532.7 / 2,924.8 = 52.4 = 52\%$	

LEGEND	
	NEW WALL
	EXISTING WALL TO REMAIN
	EXISTING STRUCTURE TO BE REMOVED
DIMENSIONS	
	FACE OF FINISH
	FACE OF STUD

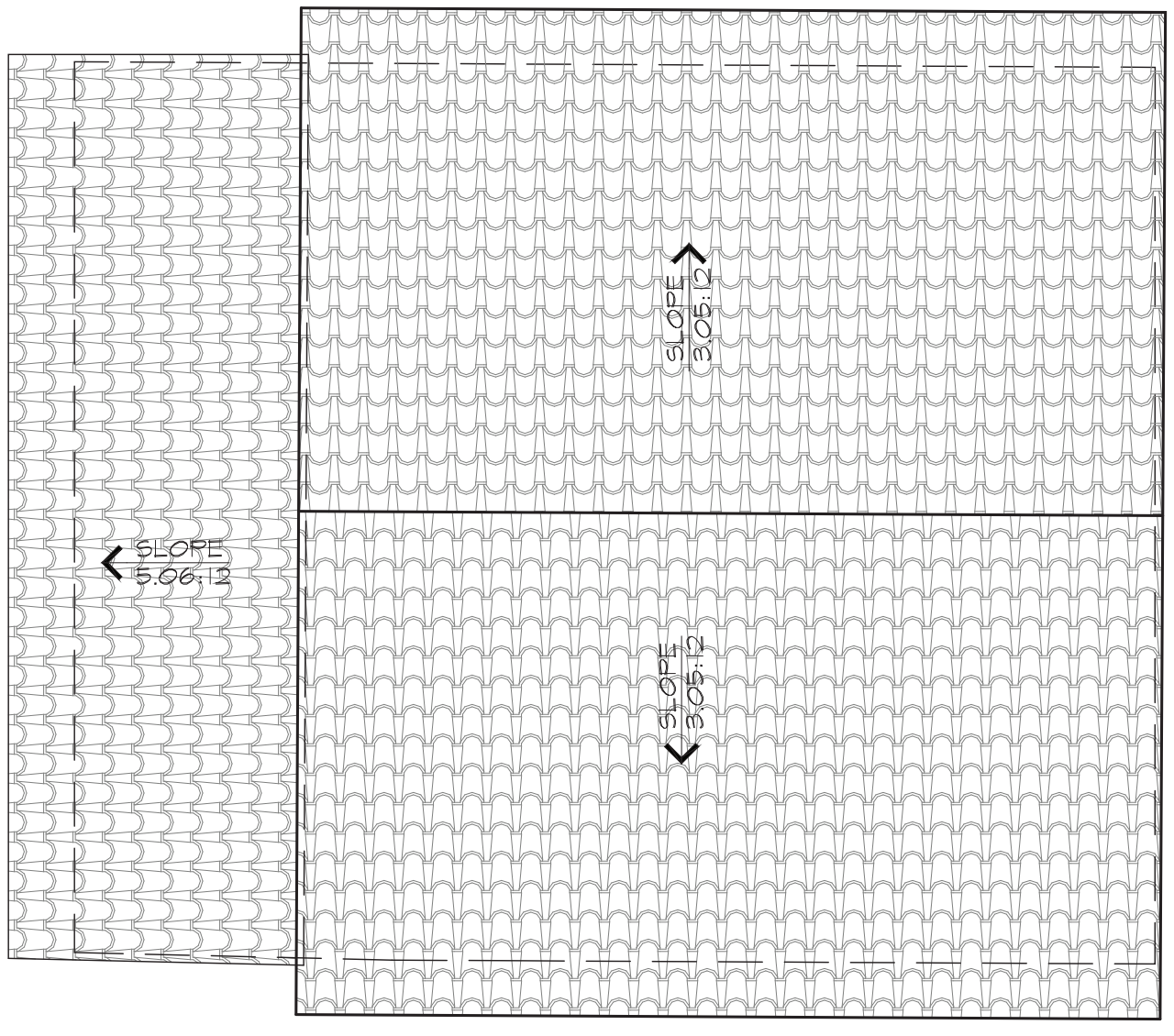

4 Proposed Roof Plan
Scale: 1/4" = 1'-0"

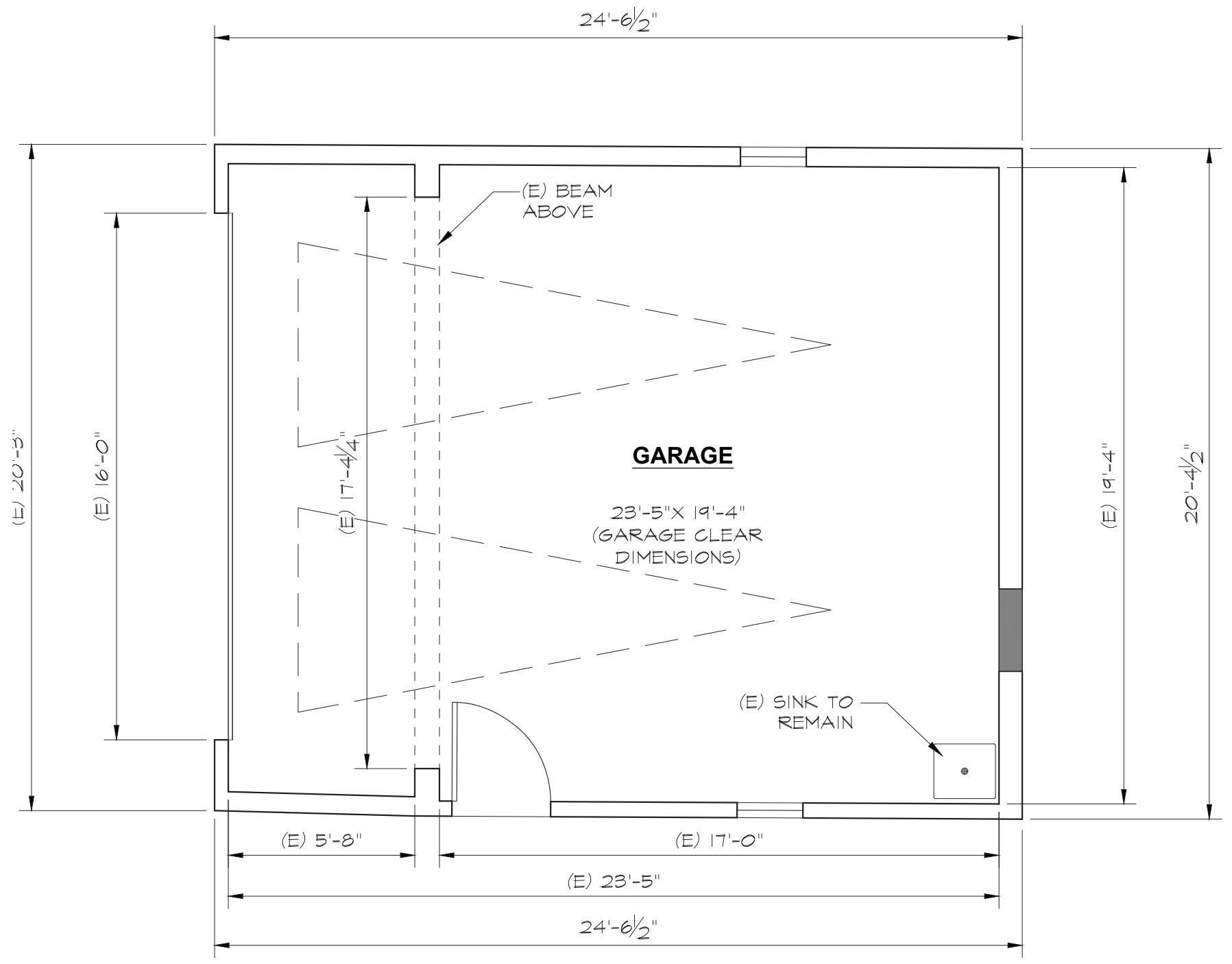

2 Proposed Floor Plan
Scale: 1/4" = 1'-0"

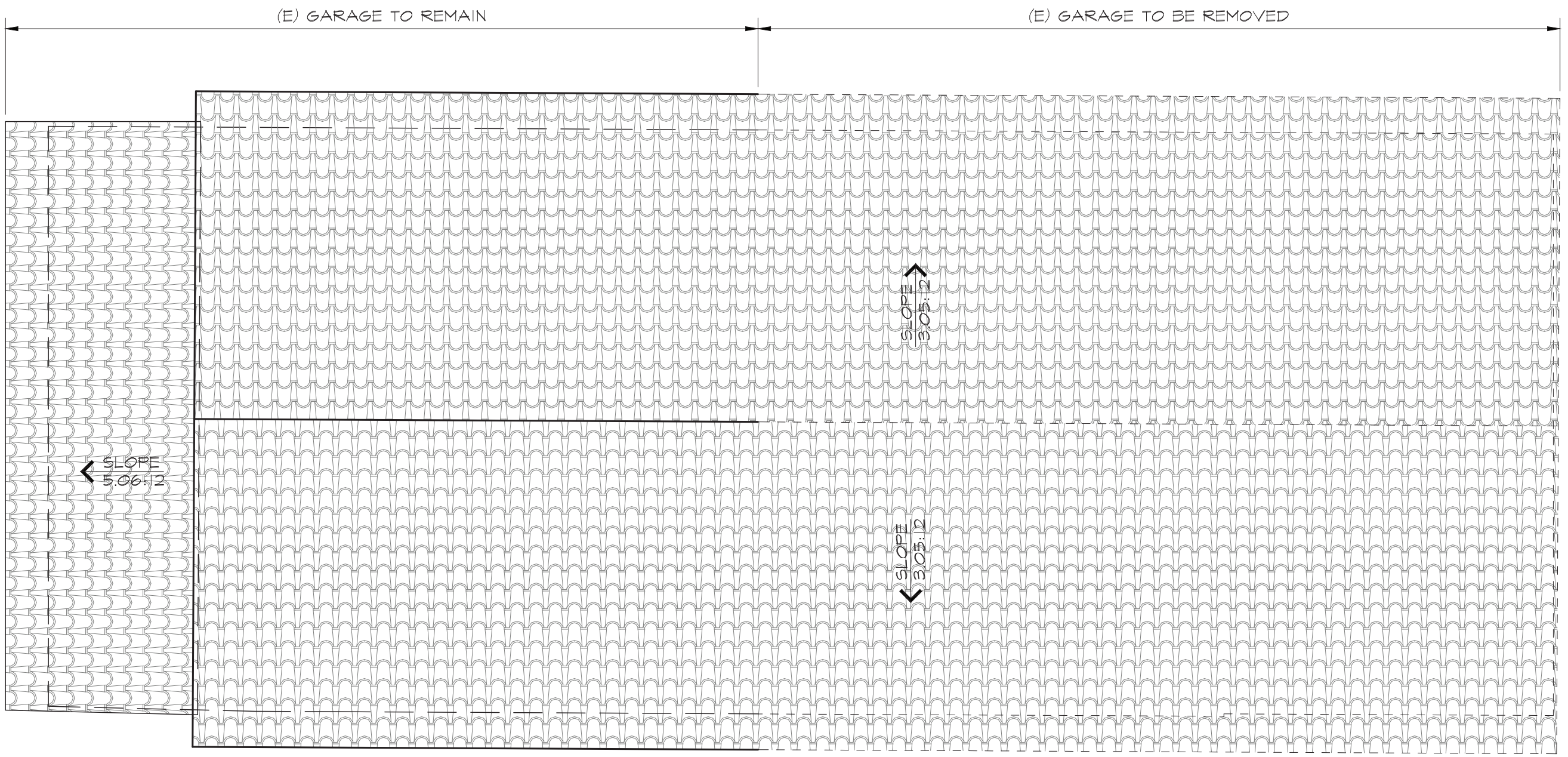

3 Demolition Roof Plan
Scale: 1/4" = 1'-0"

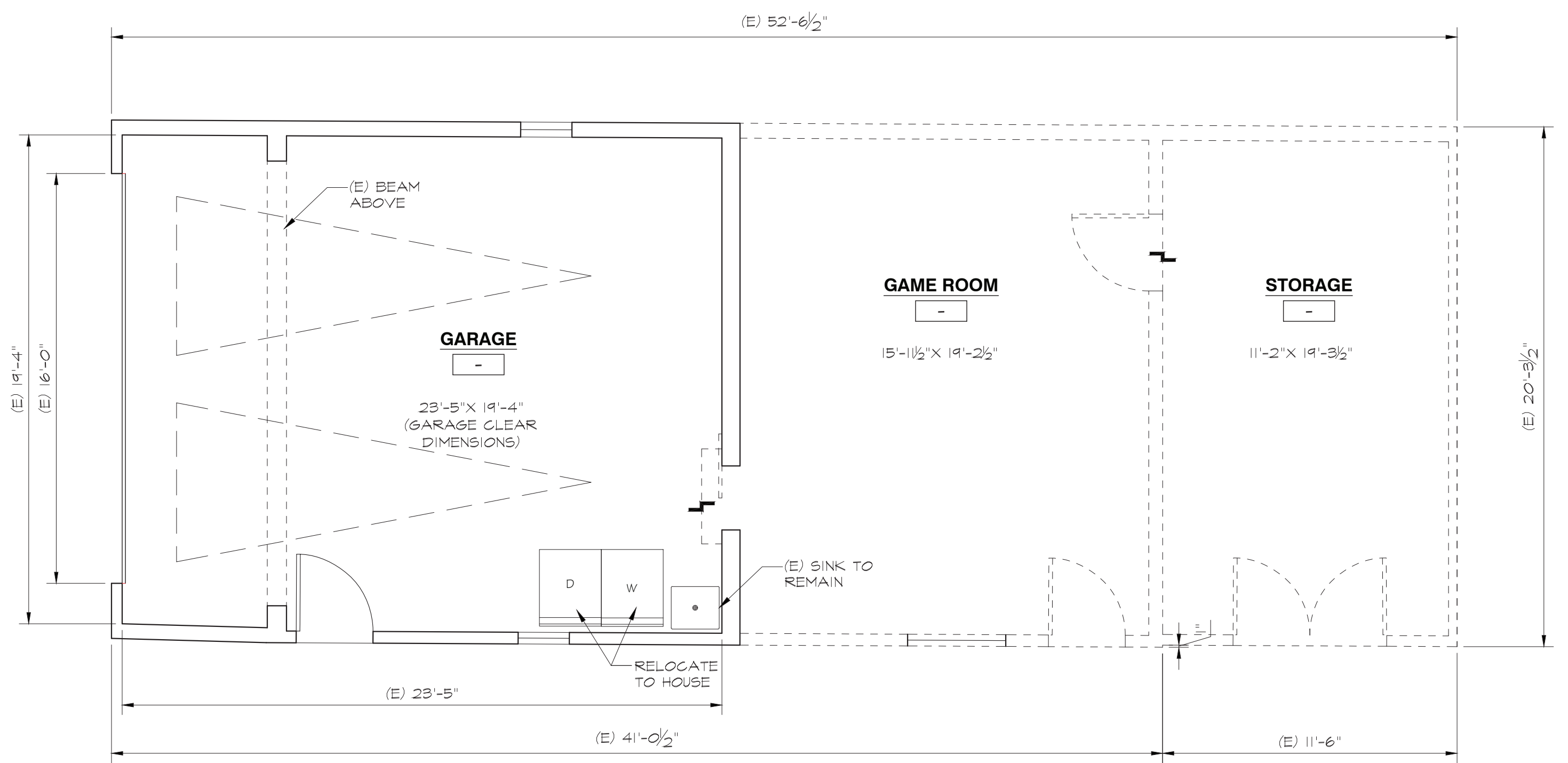

1 Demolition Floor Plan
Scale: 1/4" = 1'-0"

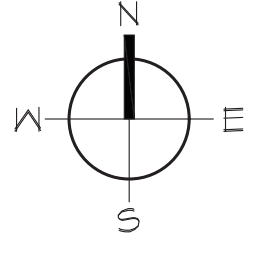

DATE

KELLY SUTHERLIN McLEOD
ARCHITECTURE, INC.
3827 Long Beach Blvd. | Long Beach, CA 90807
562-427-6697 | 562-427-0527 fax
ksm@ksmarchitecture.com | www.ksmarchitecture.com

Garage Proposed and Dismantle Floor and Roof Plan

PROJECT ISSUES / SUBMITTALS	DATE
PRE-APPLICATION	1/25/20
PRE-APPLICATION REV.	2/23/20
ADMINISTRATIVE	03/04/21
ADMINISTRATIVE	03/24/21
ADMINISTRATIVE REV. 1	04/27/21
EXEMPTION APP. REV. 2	04/27/21
DESIGN REVIEW APP.	04/27/21

KEEGAN RESIDENCE
1622 Ard Evin Avenue
Glendale, Ca 91202

Date: 07/22/2021
Drawn: KSM ARCHITECTURE, INC.
Job: -
Sheet: **A-3.2**

NOTES

1. NON-ORIGINAL STUCCO FINISH AT HOUSE TO RECEIVE (N) FLOAT FINISH TO MATCH ORIGINAL FINISH, TYPICAL ALL ELEVATIONS. ORIGINAL STUCCO FINISH WHERE OCCURS, TO REMAIN. STUCCO AT ADDITION TO MATCH ORIGINAL STUCCO FINISH.

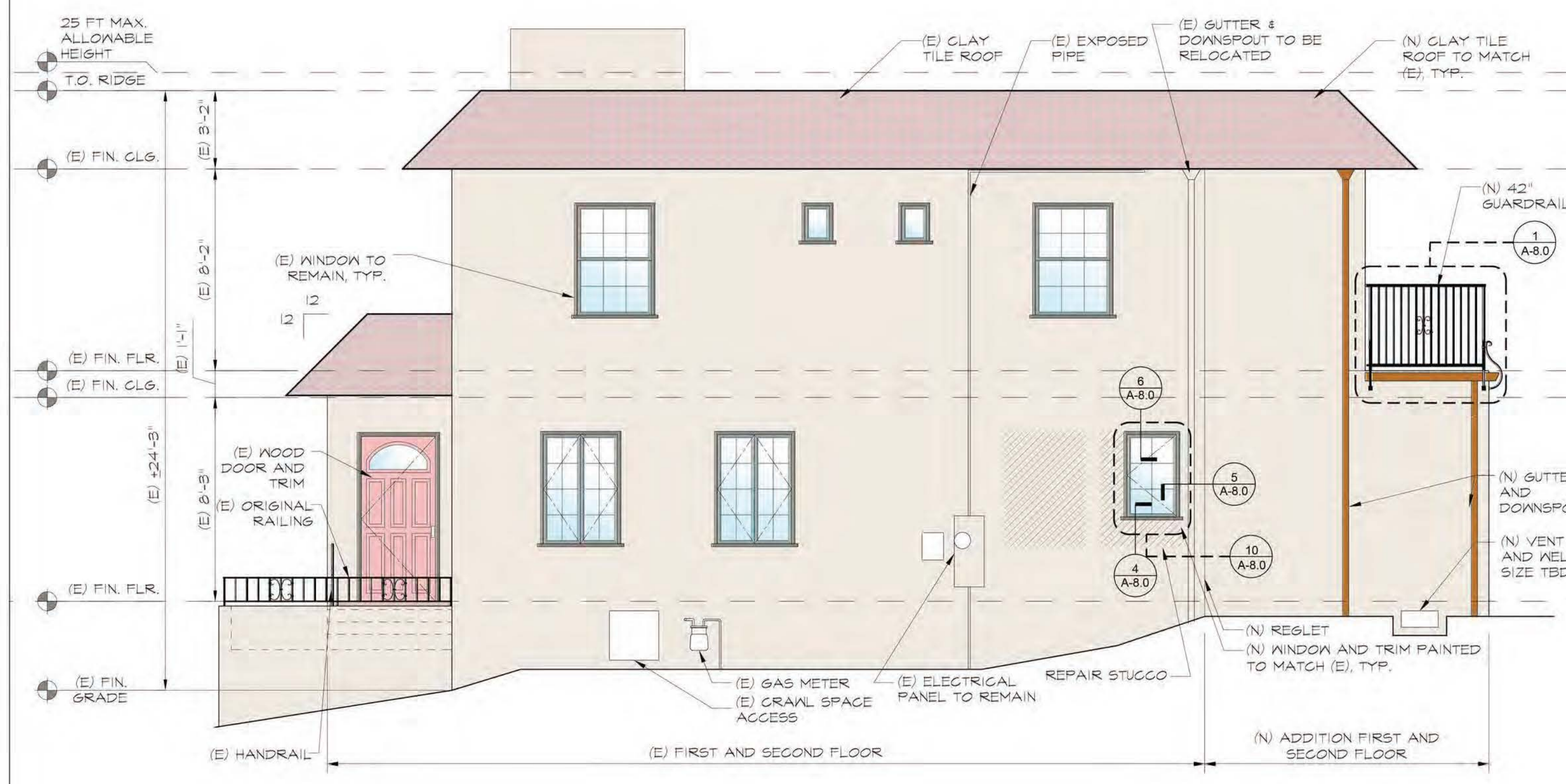

4 Proposed South Elevation
Scale: 1/4" = 1'-0"



2 Proposed West Elevation
Scale: 1/4" = 1'-0"



3 Existing South Elevation
Scale: 1/4" = 1'-0"



1 Existing West Elevation
Scale: 1/4" = 1'-0"

DATE

KELLY SUTHERLIN McLEOD
ARCHITECTURE, INC.
3827 Long Beach Blvd. | Long Beach, CA 90807
562.427.6697 tel | 562.427.0527 fax
ksm@ksmarchitecture.com | www.ksmarchitecture.com

House
Exterior Elevation -
Existing and Proposed

PROJECT ISSUES / SUBMITTALS	DATE
APPLICATION	11/25/20
PRE-APPLICATION REV.	12/29/20
EXHIBIT REV.	03/04/21
ADDITIONAL APP.	03/23/21
EXHIBIT REV. 1	04/27/21
ADDITIONAL APP. REV. 2	04/27/21
ADDITIONAL APP. REV. 2	04/27/21
DESIGN REVIEW APP.	

DATE: 07/22/2021
DRAWN: KSM ARCHITECTURE, INC.
JOB:
SHEET: **A-4.0**

07/22/21 - Design Review Application

NOTES
 1. NON-ORIGINAL STUCCO FINISH AT HOUSE TO RECEIVE (N) FLOAT FINISH TO MATCH ORIGINAL FINISH, TYPICAL ALL ELEVATIONS. ORIGINAL STUCCO FINISH WHERE OCCURS, TO REMAIN. STUCCO AT ADDITION TO MATCH ORIGINAL STUCCO FINISH.

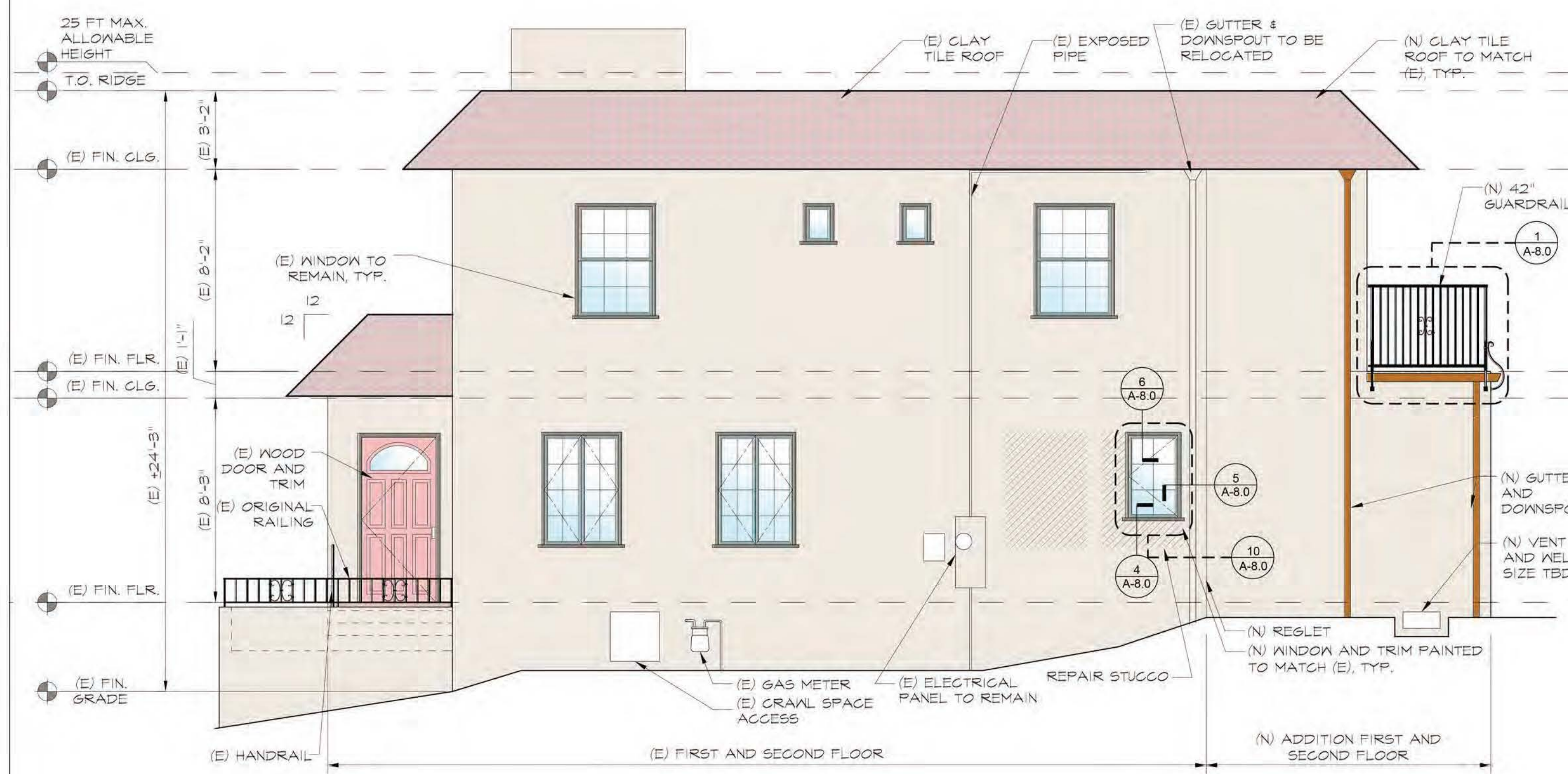

4 Proposed South Elevation
 Scale: 1/4" = 1'-0"



2 Proposed West Elevation
 Scale: 1/4" = 1'-0"



3 Existing South Elevation
 Scale: 1/4" = 1'-0"



1 Existing West Elevation
 Scale: 1/4" = 1'-0"

DATE

SHEET REVISIONS

KELLY SUTHERLIN McLEOD
 ARCHITECTURE, INC.
 3827 Long Beach Blvd. | Long Beach, CA 90807
 562.427.6697 tel | 562.427.0527 fax
 ksm@ksmarchitecture.com | www.ksmarchitecture.com

House
 Exterior Elevation -
 Existing and Proposed

PROJECT ISSUES / SUBMITTALS	DATE
APPLICATION	11/25/20
PRE-APPLICATION REV.	12/25/20
EXHIBIT REV.	03/04/21
ADDITIONAL APP.	03/23/21
EXHIBIT REV. 1	04/27/21
ADDITIONAL APP. REV. 2	04/27/21
ADDITIONAL APP. REV. 2	04/27/21
DESIGN REVIEW APP.	

KEEGAN RESIDENCE
 1622 Ard Eevin Avenue
 Glendale, Ca 91202

Date: 07/22/2021
 Drawn: KSM ARCHITECTURE, INC.
 Job: -
 Sheet: A-4.0

07/22/21 - Design Review Application

NOTES
 1. NON-ORIGINAL STUCCO FINISH AT HOUSE TO RECEIVE (N) FLOAT FINISH TO MATCH ORIGINAL FINISH. TYPICAL ALL ELEVATIONS. ORIGINAL STUCCO FINISH WHERE OCCURS TO REMAIN. STUCCO AT ADDITION TO MATCH ORIGINAL STUCCO FINISH.



4 Proposed East Elevation
 Scale: 1/4" = 1'-0"

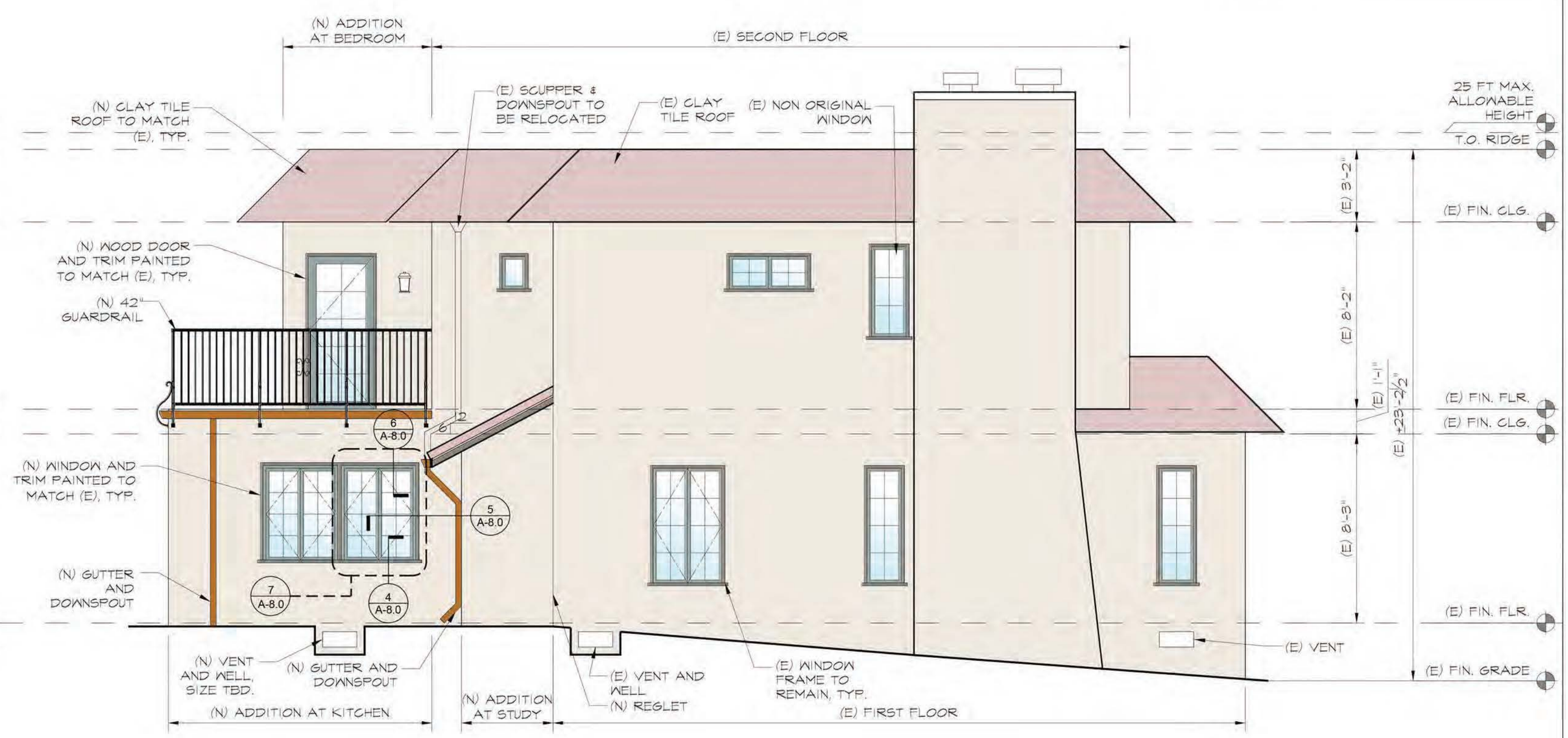

2 Proposed North Elevation
 Scale: 1/4" = 1'-0"



3 Existing East Elevation
 Scale: 1/4" = 1'-0"

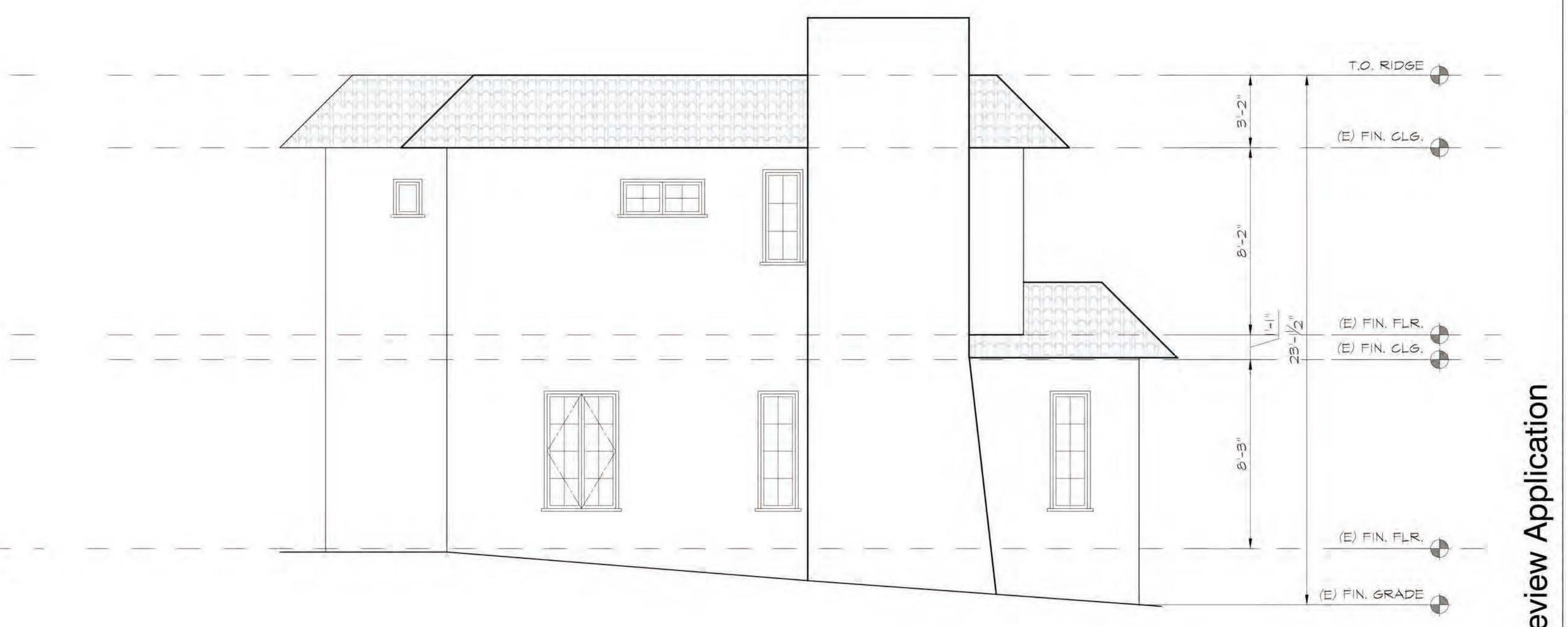

1 Existing North Elevation
 Scale: 1/4" = 1'-0"

DATE

SHEET REVISIONS

KELLY SUTHERLIN McLEOD
 ARCHITECTURE, INC.
 3827 Long Beach Blvd. | Long Beach, CA 90807
 562.427.6697 tel | 562.427.0527 fax
 ksm@ksmarchitecture.com | www.ksmarchitecture.com

PROJECT	ISSUES / SUBMITTALS	DATE
PRE-APPLICATION	11/25/20	11/25/20
PRE-APPLICATION REV.	12/29/20	12/29/20
ADMINISTRATIVE	09/04/21	09/04/21
EXEMPTION APP	09/24/21	09/24/21
EXEMPTION APP REV 1	04/27/21	04/27/21
ADMINISTRATIVE	04/27/21	04/27/21
EXEMPTION APP REV 2	04/27/21	04/27/21
DESIGN REVIEW APP.	04/27/21	04/27/21

07/22/21 - Design Review Application

KEEGAN RESIDENCE
 1622 Ard Eevin Avenue
 Glendale, Ca 91202

Date: 07/22/2021
 Drawn: KSM ARCHITECTURE, INC.
 Job: -
 Sheet: A-4.1

House
 Exterior Elevation -
 Existing and Proposed

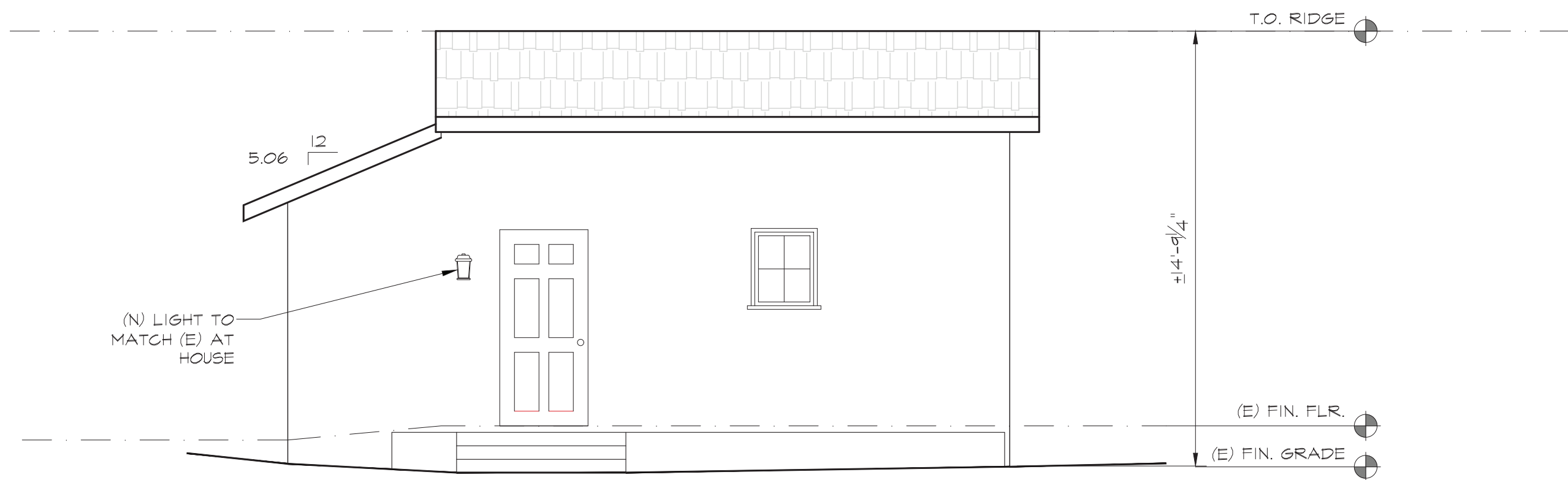

4 Proposed South Elevation

Scale: 1/4" = 1'-0"

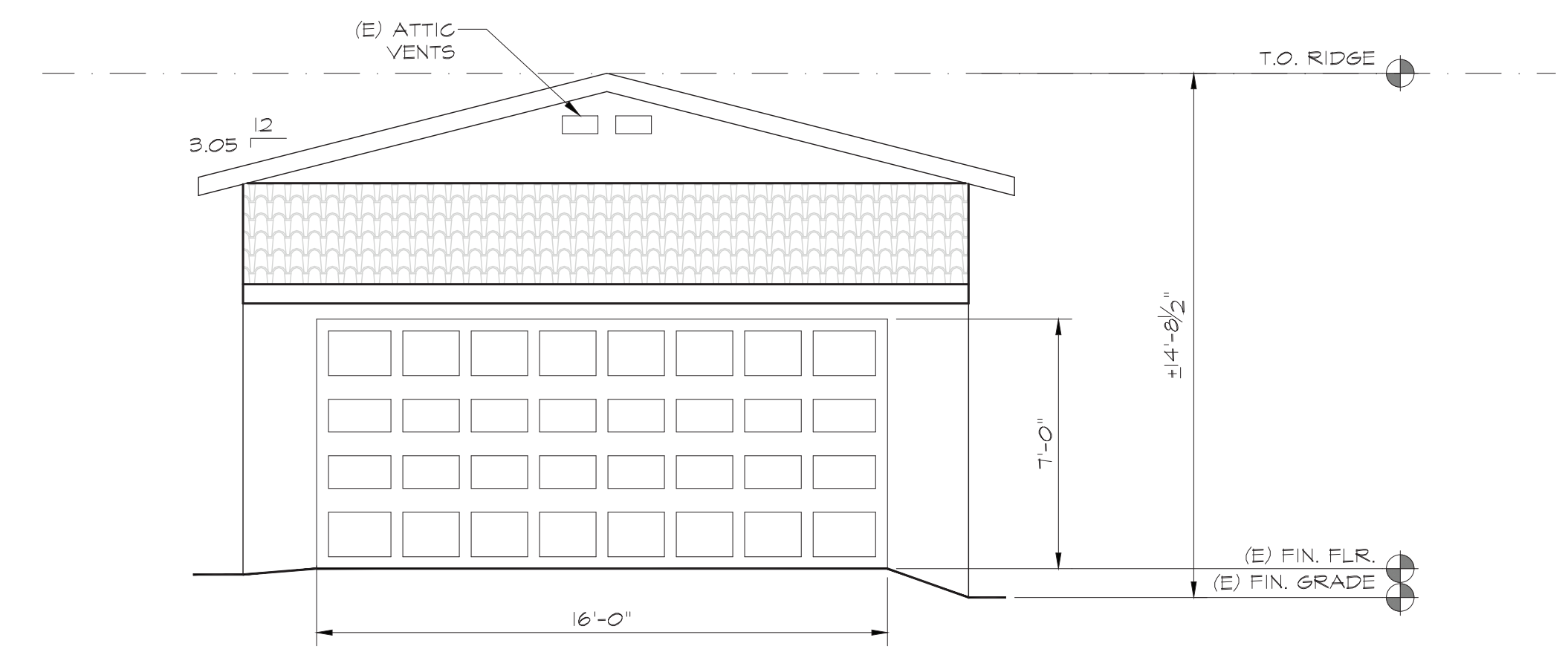

2 Proposed West Elevation

Scale: 1/4" = 1'-0"

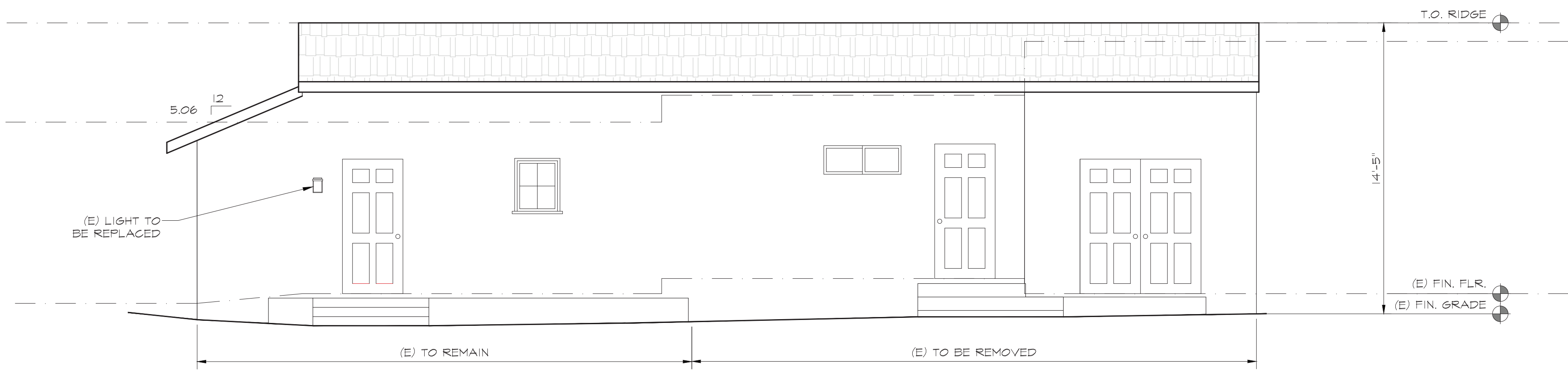

3 Existing South Elevation

Scale: 1/4" = 1'-0"

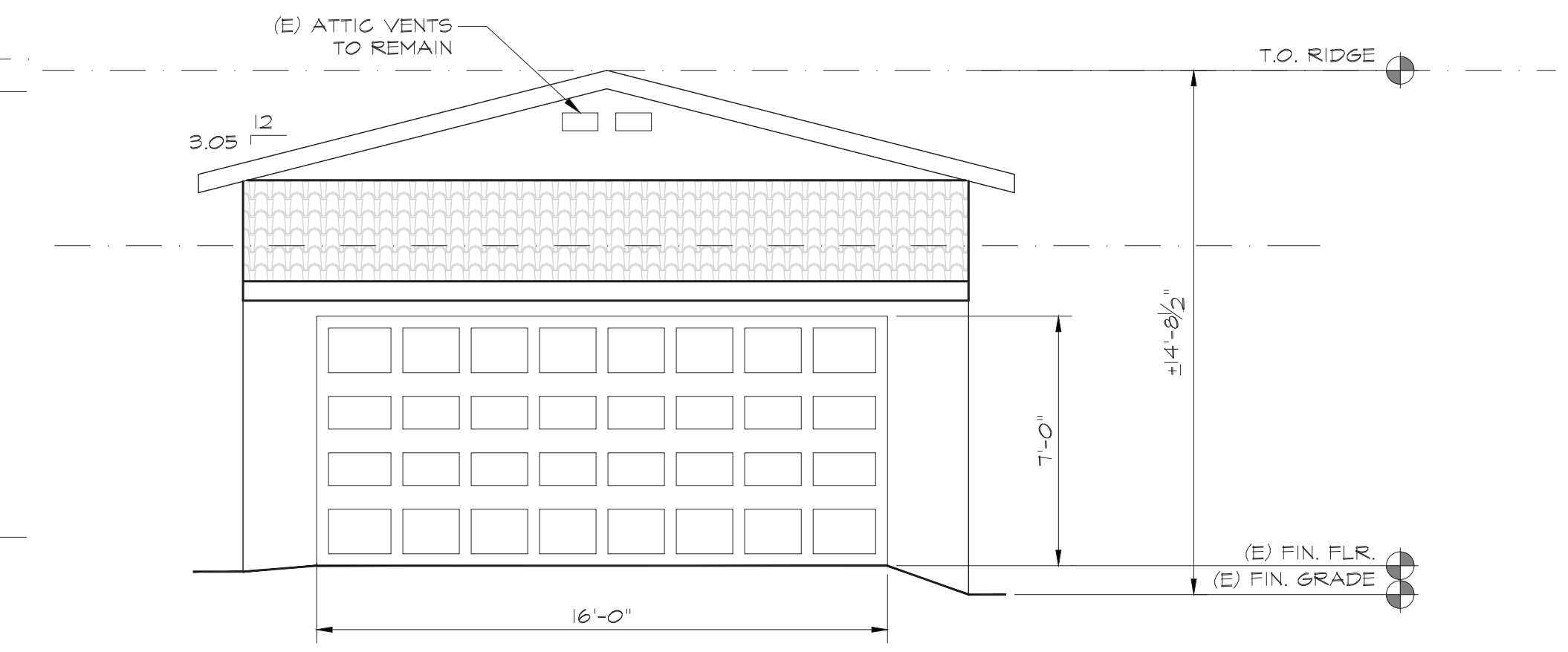

1 Existing West Elevation

Scale: 1/4" = 1'-0"

07/22/21 - Design Review Application

KEEGAN RESIDENCE
1622 Ard Evin Avenue
Glendale, Ca 91202

Date 07/22/2021

Drawn KSM ARCHITECTURE, INC.

Job -

Sheet

A-4.2

Garage
Exterior Elevation -
Existing and Proposed



KELLY SUTHERLIN McLEOD
ARCHITECTURE, INC.

3827 Long Beach Blvd. | Long Beach, CA 90807
562-427-6697 tel | 562-427-0527 fax
ksm@ksmarchitecture.com | www.ksmarchitecture.com

SHEET REVISIONS

DATE

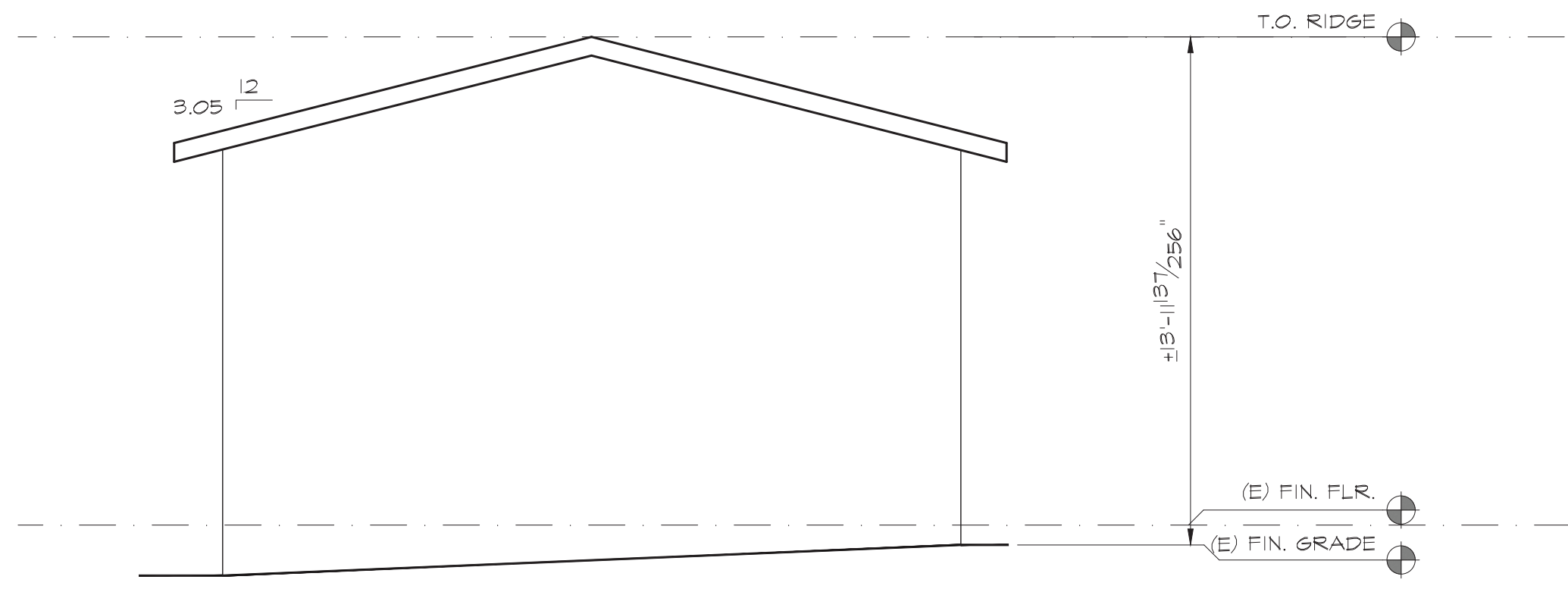

4 Proposed East Elevation

Scale: 1/4" = 1'-0"

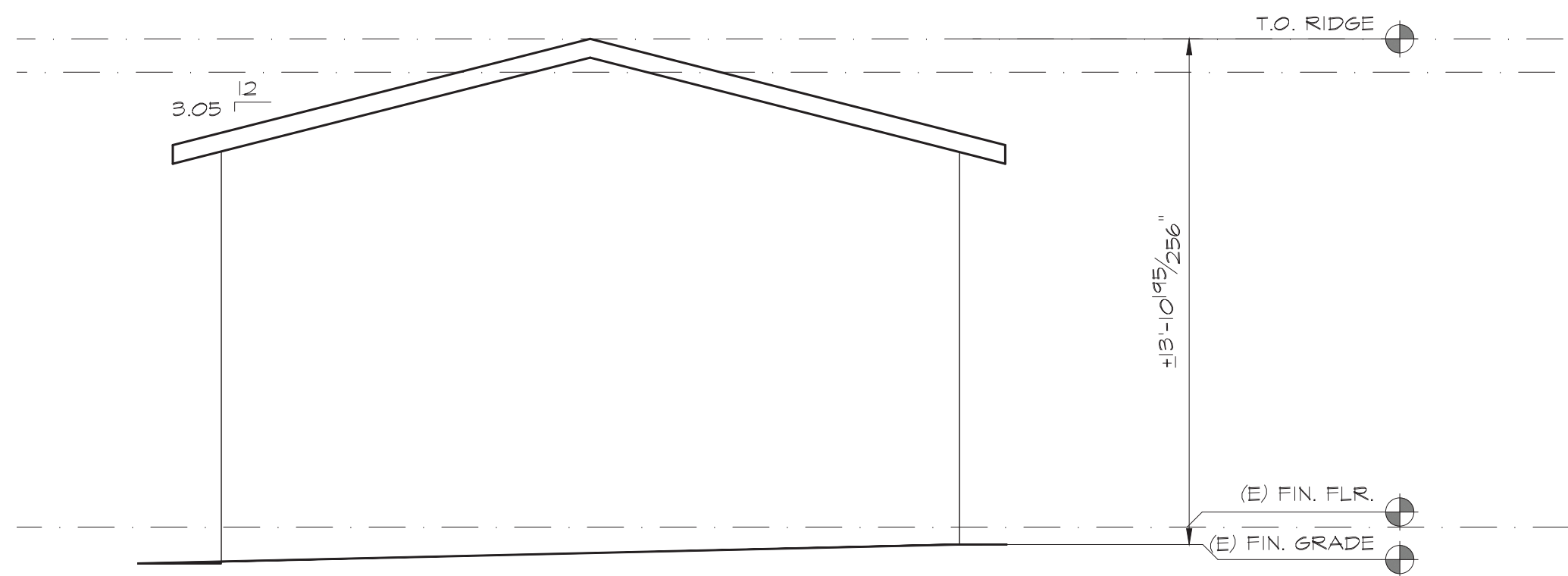

3 Existing East Elevation

Scale: 1/4" = 1'-0"

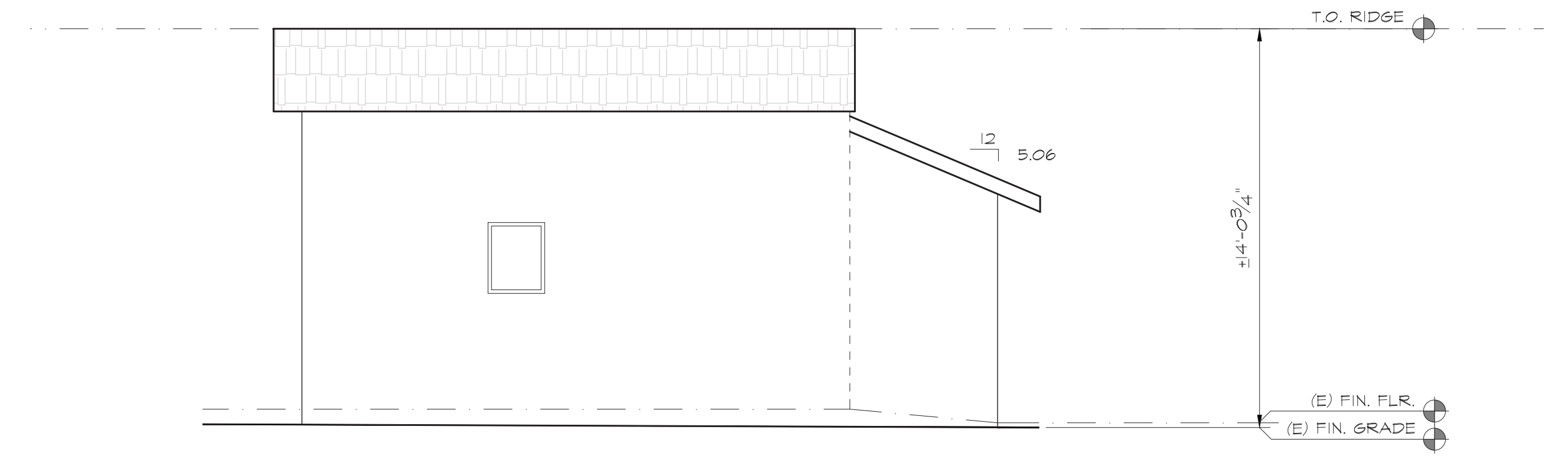

2 Proposed North Elevation

Scale: 1/4" = 1'-0"

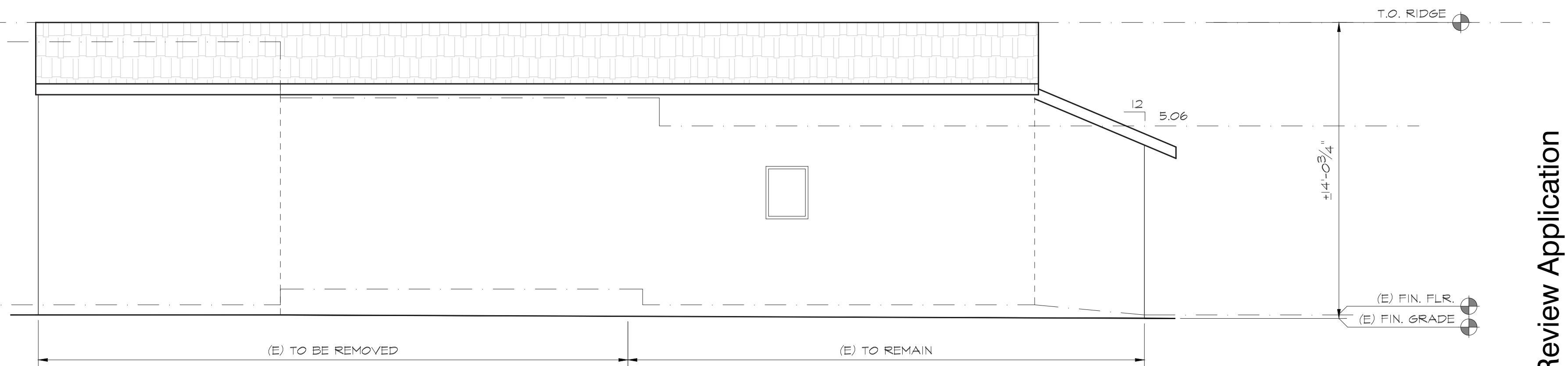

1 Existing North Elevation

Scale: 1/4" = 1'-0"

07/22/21 - Design Review Application

KEEGAN RESIDENCE
1622 Ard Evin Avenue
Glendale, Ca 91202

Date 07/22/2021
Drawn KSM ARCHITECTURE, INC.
Job -
Sheet

A-4.3

Garage
Exterior Elevation -
Existing and Proposed

PROJECT ISSUES / SUBMITTALS	DATE
PRE-APPLICATION	1/25/20
PRE-APPLICATION REV.	2/23/20
ADMINISTRATIVE	03/04/21
ADMINISTRATIVE	03/24/21
ADMINISTRATIVE REV.1	04/27/21
EXCEPTION APP. REV.2	04/27/21
DESIGN REVIEW APP.	04/27/21

KELLY SUTHERLIN McLEOD
ARCHITECTURE, INC.

3827 Long Beach Blvd. | Long Beach, CA 90807
562-427-6697 tel | 562-427-0527 fax
ksm@ksmarchitecture.com | www.ksmarchitecture.com



SHEET REVISIONS	DATE

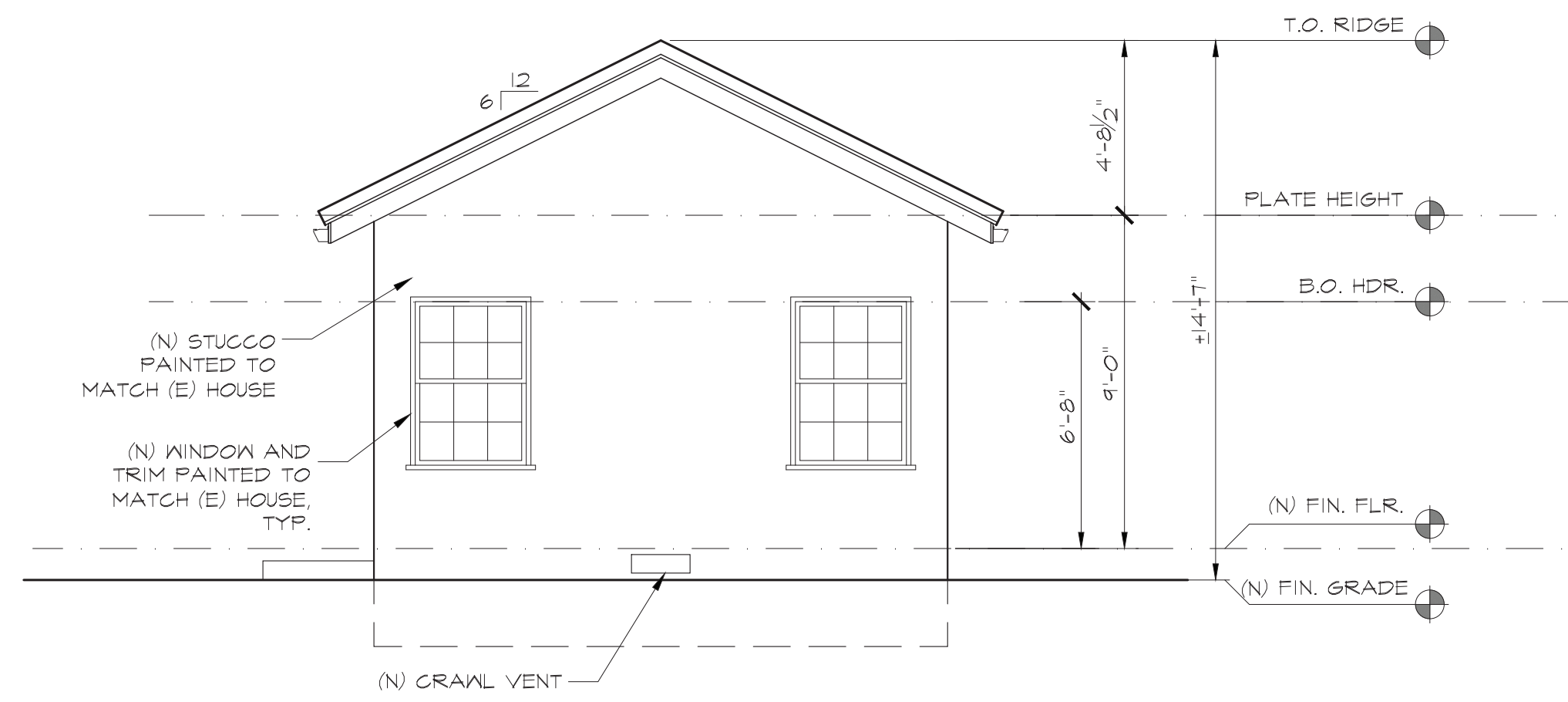

4 South Elevation

Scale: 1/4" = 1'-0"

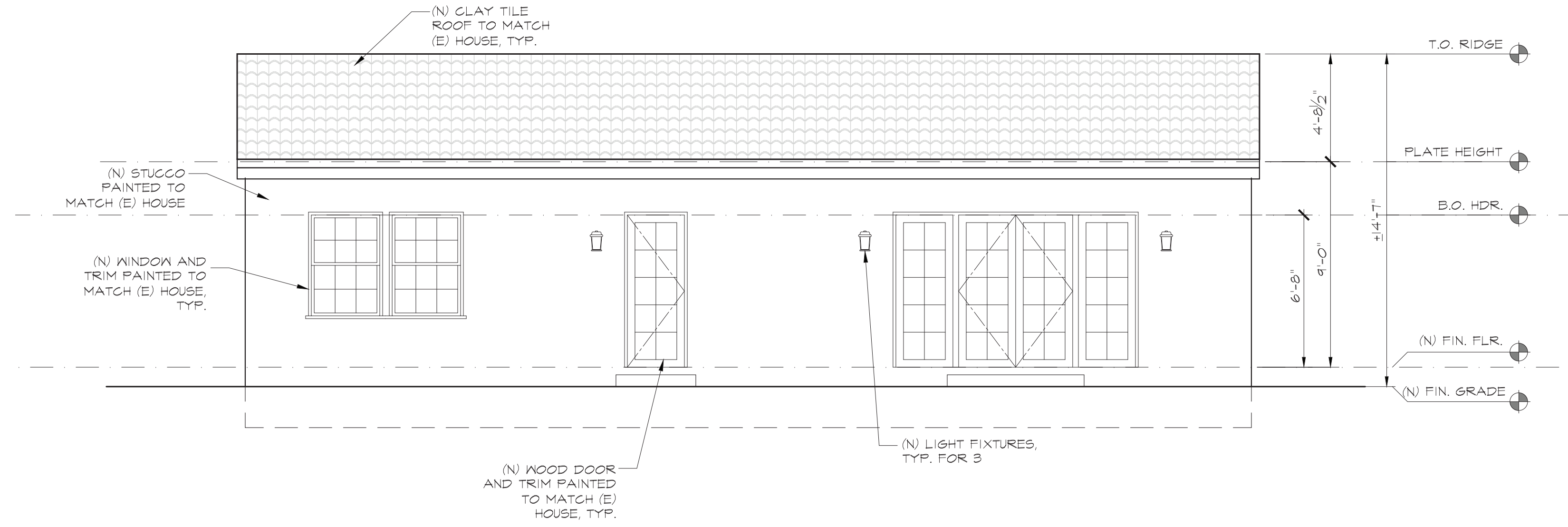

2 West Elevation

Scale: 1/4" = 1'-0"

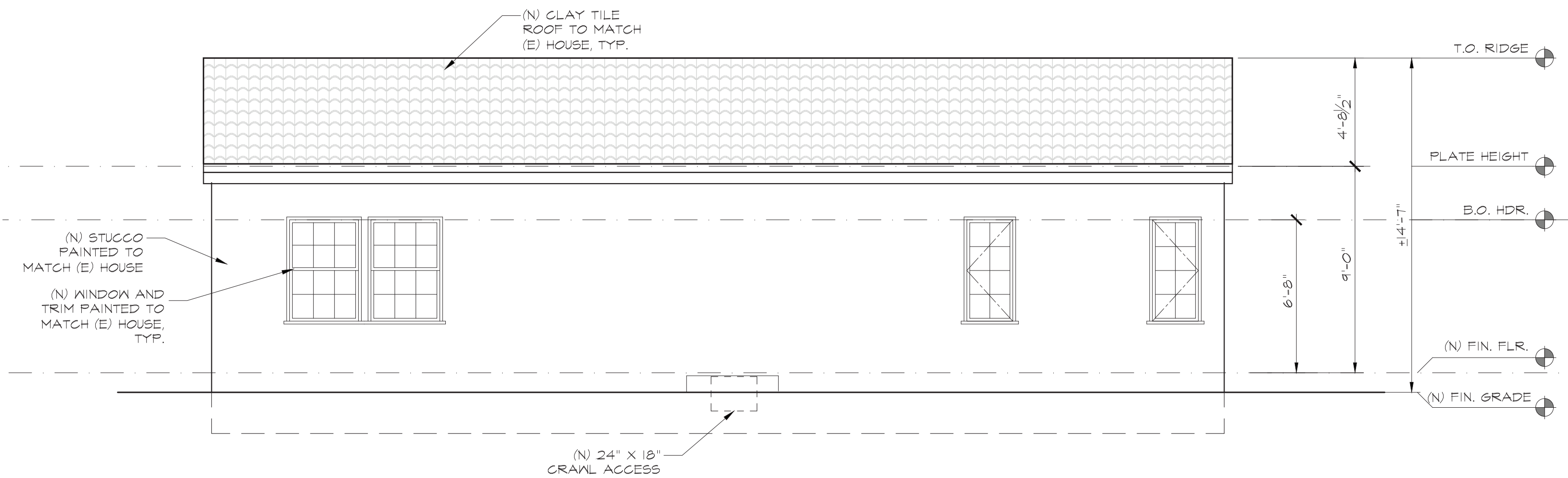

3 East Elevation

Scale: 1/4" = 1'-0"

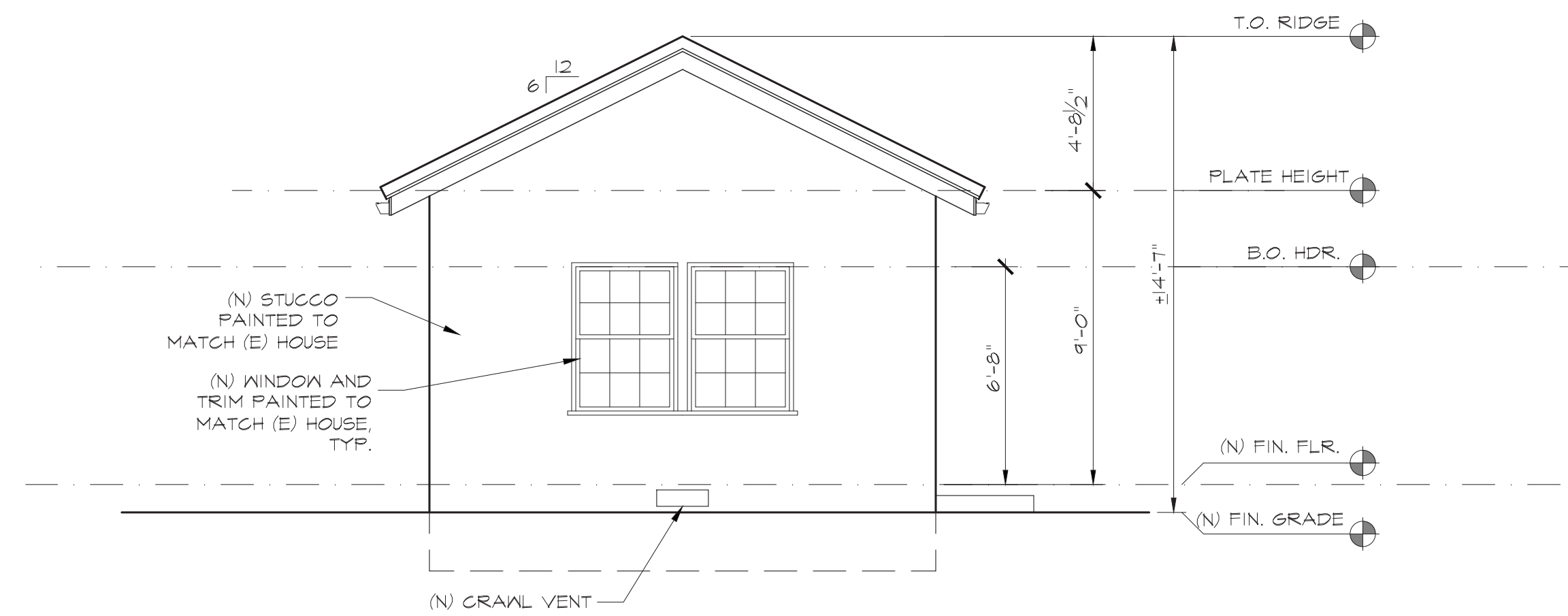

1 North Elevation

Scale: 1/4" = 1'-0"

07/22/21 - Design Review Application

KEEGAN RESIDENCE
1622 Ard Evin Avenue
Glendale, Ca 91202

Date: 07/22/2021
Drawn: KSM ARCHITECTURE, INC.
Job: -
Sheet:

A-4.4

PROJECT ISSUES / SUBMITTALS	DATE
PRE-APPLICATION	1/25/20
PRE-APPLICATION REV.	2/23/20
ADMINISTRATIVE	03/04/21
ADMINISTRATIVE	03/24/21
ADMINISTRATIVE REV. 1	04/27/21
EXEMPTION APP. REV. 2	04/27/21
DESIGN REVIEW APP.	04/27/21

New ADU Exterior
Elevation

KELLY SUTHERLIN McLEOD
ARCHITECTURE, INC.
3827 Long Beach Blvd. | Long Beach, CA 90807
562-427-6697 tel | 562-427-0527 fax
ksm@ksmarchitecture.com | www.ksmarchitecture.com



SHEET REVISIONS

DATE

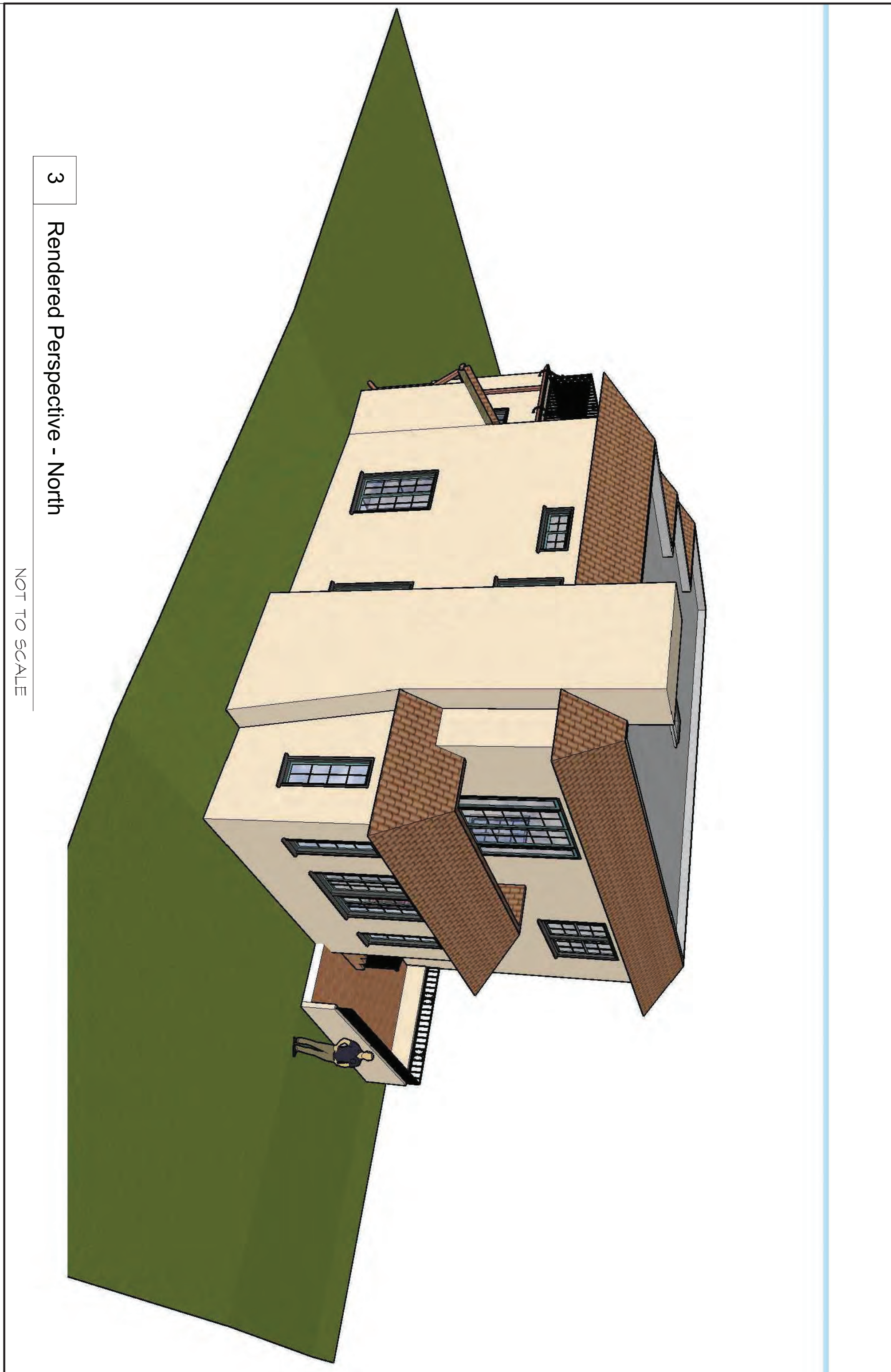

3 Rendered Perspective - North

NOT TO SCALE



4 Rendered Perspective - West Eye Level (Front)

NOT TO SCALE



1 Rendered Perspective - Southwest Corner

NOT TO SCALE



2 Rendered Perspective - Southwest Eye Level

NOT TO SCALE

07/22/21 - Design Review Application

Rendered Perspectives



KELLY SUTHERLIN McLEOD
ARCHITECTURE, INC.

3827 Long Beach Blvd. | Long Beach, CA 90807
562.427.6697 tel | 562.427.0527 fax
ksm@ksmarchitecture.com | www.ksmarchitecture.com

SHEET REVISIONS	DATE

PROJECT ISSUES / SUBMITTALS	DATE
PRE-APPLICATION	1/25/20
PRE-APPLICATION REV.	2/23/20
ADMINISTRATIVE EXEMPTION APP.	03/04/21
ADMINISTRATIVE EXEMPTION APP. REV. 1	03/24/21
ADMINISTRATIVE EXEMPTION APP. REV. 2	04/27/21
DESIGN REVIEW APP.	04/27/21

KEEGAN RESIDENCE
1622 Ard Eevin Avenue
Glendale, Ca 91202

A-4.5

Drawn: KSM ARCHITECTURE, INC.
Date: 07/22/2021
Sheet: A-4.5



4 Rendered Perspective - Southeast Eye Level

NOT TO SCALE



2 Rendered Perspective - Southeast Corner

NOT TO SCALE



3 Rendered Perspective - Northeast Eye Level

NOT TO SCALE



1 Rendered Perspective - Northeast Corner

NOT TO SCALE

DATE

SHEET REVISIONS

KELLY SUTHERLIN McLEOD
ARCHITECTURE, INC.
3827 Long Beach Blvd. | Long Beach, CA 90807
562-427-6697 tel | 562-427-0527 fax
ksm@ksmarchitecture.com | www.ksmarchitecture.com



Rendered Perspectives

PROJECT / SUBMITTALS	DATE
ISSUES / SUBMITTALS	1/25/20
PRE-APPLICATION REV.	2/23/20
ADMINISTRATIVE	03/04/21
ADMINISTRATIVE	03/24/21
ADMINISTRATIVE REV.1	04/27/21
ADMINISTRATIVE REV.2	04/27/21
DESIGN REVIEW APP.	04/27/21

07/22/21 - Design Review Application

KEEGAN RESIDENCE
1622 Ard Evin Avenue
Glendale, Ca 91202

Date: 07/22/2021
Drawn: KSM ARCHITECTURE, INC.
Job: -
Sheet: A-4.6

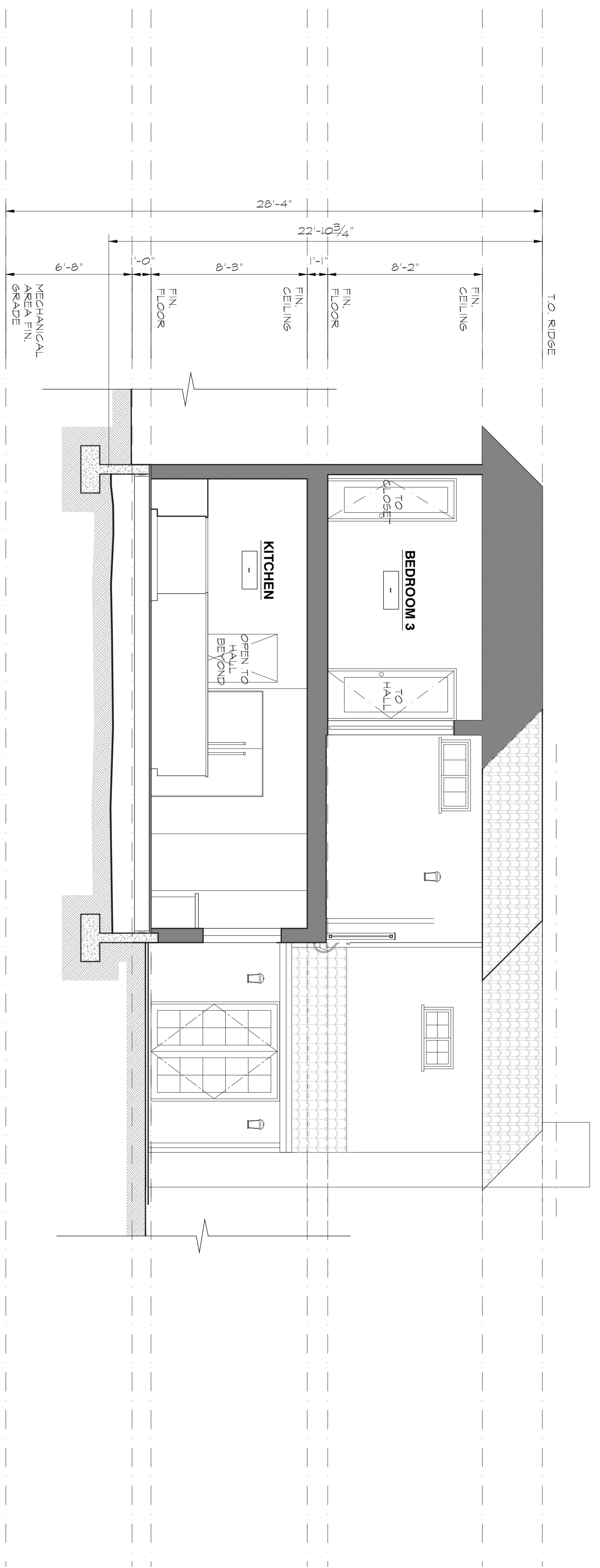

2 Main House Building Section

Scale: 1/4" = 1'-0"



1 Main House Building Section

Scale: 1/4" = 1'-0"

07/22/21 - Design Review Application

Sheet
A-5.0

KEEGAN RESIDENCE
1622 Ard Eevin Avenue
Glendale, Ca 91202

PROJECT ISSUES / SUBMITTALS	DATE
PRE-APPLICATION	1/25/20
PRE-APPLICATION REV.	2/23/20
ADMINISTRATIVE EXEMPTION APP.	03/04/21
ADMINISTRATIVE EXEMPTION APP. REV 1	03/24/21
ADMINISTRATIVE EXEMPTION APP. REV 2	04/27/21
DESIGN REVIEW APP.	04/27/21

House Building Section



KELLY SUTHERLIN McLEOD
ARCHITECTURE, INC.
3827 Long Beach Blvd. | Long Beach, CA 90807
562.427.6697 tel | 562.427.0527 fax
ksm@ksmarchitecture.com | www.ksmarchitecture.com

SHEET REVISIONS	DATE

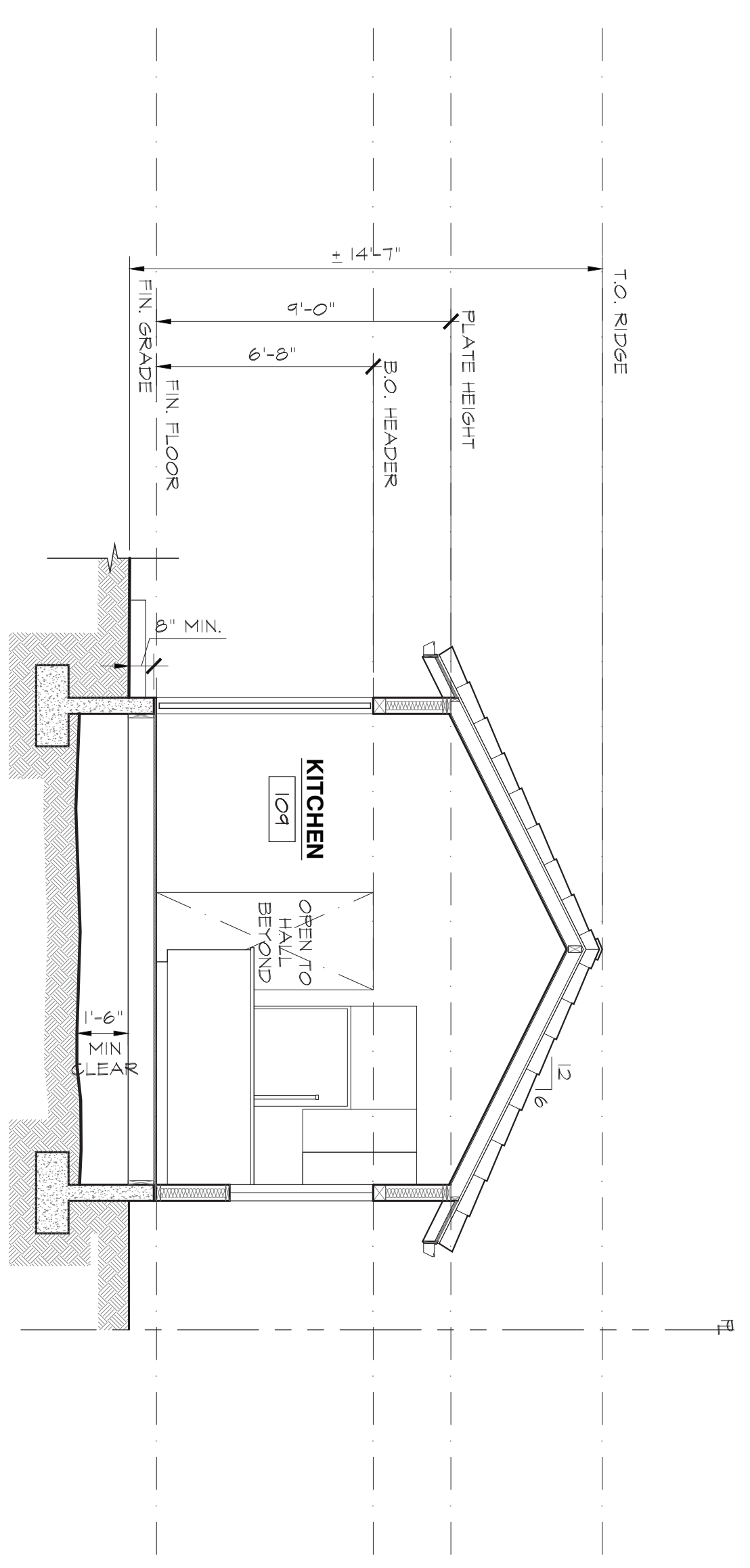
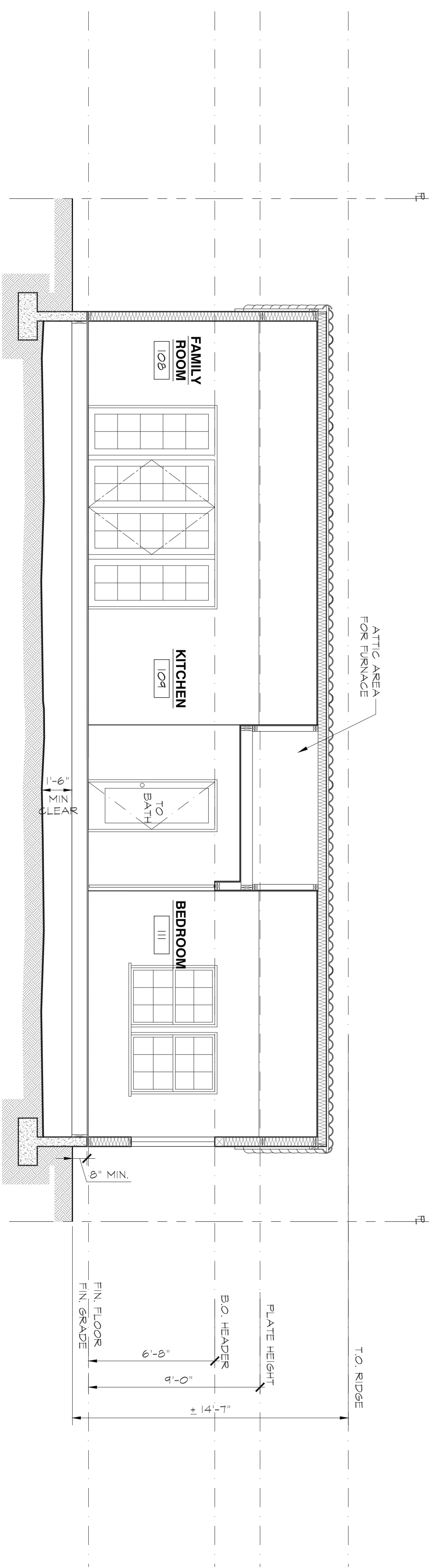

1 ADU Building Section

Scale: 1/4" = 1'-0"

2 ADU Building Section

Scale: 1/4" = 1'-0"

07/22/21 - Design Review Application

Sheet: A-5.1

KEEGAN RESIDENCE
1622 Ard Eevin Avenue
Glendale, Ca 91202

PROJECT ISSUES / SUBMITTALS	DATE
PRE-APPLICATION	1/25/20
PRE-APPLICATION REV.	2/23/20
ADMINISTRATIVE EXEMPTION APP.	03/04/21
ADMINISTRATIVE EXEMPTION APP. REV 1	03/29/21
ADMINISTRATIVE EXEMPTION APP. REV 2	04/27/21
DESIGN REVIEW APP.	04/27/21

New ADU Building Section



KELLY SUTHERLIN McLEOD ARCHITECTURE, INC.
3827 Long Beach Blvd. | Long Beach, CA 90807
562.427.6697 tel | 562.427.0527 fax
ksm@ksmarchitecture.com | www.ksmarchitecture.com

SHEET REVISIONS	DATE

DOOR SCHEDULE												
ROOM #	DOOR # E) OR (N)	PANEL SIZE		TYPE	SCREEN WOOD	GLAZING see also remarks)	DETAILS			HRDW	B.O. HEADER	REMARKS
		WIDTH	HEIGHT				THRES.	JAMB	HEAD			
HOUSE FIRST FLOOR												
101 LIVING ROOM	101 (E)	3'-0"	6'-8"	D	-	-	-	-	-	EXIST.	-	
102 STUDY	102 (E)	5'-0"		B	Y	-	-	-	-	↓	-	(E) DOOR AT (N) LOCATION
104 KITCHEN	103 (N)	5'-0"		↓	↓	TEMPERED	-	-	-	-	-	
105 PANTRY	104 (N)	2'-6"		F	-	-	-	-	-	-	-	
106 LAUNDRY	105 (N)	↓	↓	↓	-	-	-	-	-	-	-	
HOUSE SECOND FLOOR												
201 BEDROOM 3	201 (N)	2'-10"	6'-8"	A	Y	TEMPERED	-	-	-	-	-	
203 BEDROOM 1	202 (E)	7'-11"	↓	C	↓	-	-	-	-	EXIST.	-	
ADU FIRST FLOOR												
08 FAMILY ROOM	106 (N)	10'-6"	6'-8"	C	Y	TEMPERED	-	-	-	-	-	
10 BATH	107 (N)	2'-6"		A	-	↓	-	-	-	-	-	
↓	108 (N)			F	-	-	-	-	-	-	-	
111 BEDROOM	109 (N)			↓	-	-	-	-	-	-	-	
↓	110 (N)	↓	↓	↓	-	-	-	-	-	-	-	

- DOOR NOTES FOR MANUFACTURER AND CONTRACTOR:**
- GLAZING IN HAZARDOUS LOCATIONS SHALL BE TEMPERED. GLASS PANELS AT INGRESS AND EGRESS DOORS SHALL BE TEMPERED, PANELS IN SLIDING OR SWINGING DOORS SHALL BE TEMPERED. GLAZING SHALL BE TEMPERED IF WITHIN 24" OF VERTICAL EDGE OF CLOSED DOOR AND WITHIN 5'-0" OF STANDING SURFACE. (I.E.: STAIR)
 - ALL TEMPERED GLASS AT WINDOWS, DOORS AND SHOWER ENCLOSURES TO BE WITHOUT VISIBILITY MARKINGS AFTER INSTALLATION. CERTIFICATES FOR TEMPERING TO BE AVAILABLE ON SITE FOR INSPECTOR THEN DELIVERED TO OWNER. CONTRACTOR TO VERIFY WITH CITY INSPECTOR.
 - DIMENSIONS OF ALL EXISTING AND NEW DOOR OPENINGS TO BE CONFIRMED ON-SITE BY CONTRACTOR PRIOR TO ORDERING. ALL DOOR SIZES TO BE FIELD VERIFIED BY CONTRACTOR PRIOR TO ORDERING.
 - HEADER HEIGHTS OF (N) DOORS TO MATCH (E) U.N.O.
 - CONTRACTOR TO FIELD VERIFY & CONFIRM ALL HEIGHTS W/ ARCHITECT.
 - ALL DOOR SIZES LISTED ARE OUTSIDE DIMENSIONS OF OPERABLE PANEL(S).
 - SEE FLOOR PLANS FOR DOOR SWING DIRECTION.
 - JOHNSON HARDWARE TO BE USED AT ALL POCKET DOORS OR APPROVED EQUAL.
 - GLASS AT (E) DOORS TO REMAIN U.N.O.
 - ALL NEW DOORS TO BE ENERGY EFFICIENT TO COMPLY WITH TITLE 24.
 - ORDER TO BE SUBMITTED FOR REVIEW TO ARCHITECT PRIOR TO MANUFACTURE. ALL DIMENSIONS TO BE CONFIRMED WITH MANUFACTURE'S DETAILS.
 - DOORS TO BE 1-3/4" THICK U.N.O.
 - GENERAL CONTRACTOR TO VERIFY OR IDENTIFY JAMBS THAT MAY NEED ADDITIONAL DEPTH TO ACCOMMODATE SHEAR WALLS.

DOOR TYPES

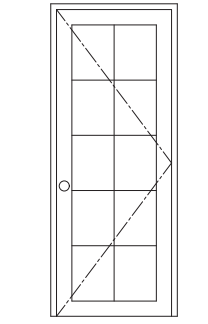
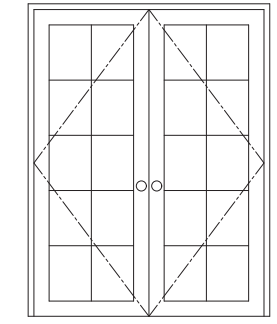
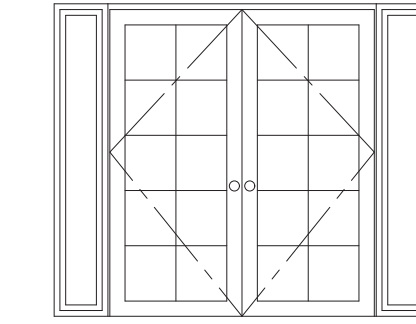
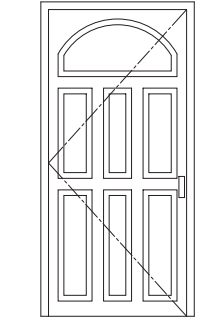
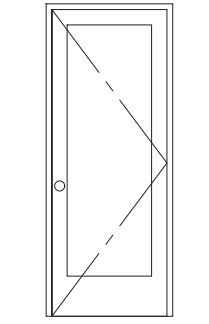
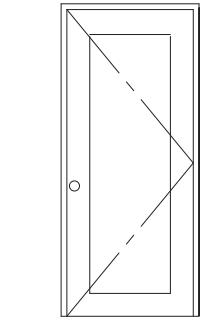
A EXTERIOR DOOR W/GLAZING 	B EXTERIOR DOUBLE DOOR W/GLAZING 	C EXTERIOR DOUBLE DOOR W/GLAZING AND SIDELIGHTS 	D EXTERIOR DOOR W/PANELING AND GLAZING 	E EXTERIOR DOOR SCREEN DOOR 	F INTERIOR SOLID CORE ONE PANEL DOOR 
---	--	---	--	---	---

Note :
ALL DOORS & WINDOWS SHALL MEET CITY OF GLENDALE'S SECURITY ORDINANCE.

DOOR HARDWARE LEGEND

STYLE NUMBER	ITEM	MANUFACTURER	STYLE	MODEL NUMBER	FINISH AND/OR COLOR	REMARKS
A	INTERIOR SOLID CORE ONE PANEL	-	-	-	-	-
B	EXTERIOR DOOR W/ GLAZING	-	-	-	-	-
C	EXTERIOR DOUBLE DOOR W/GL.	-	-	-	-	-
D	INTERIOR POCKET DOOR	-	-	-	-	-
E	EXTERIOR SCREEN DOOR	-	-	-	-	-

07/22/21 - Design Review Application

	DATE	
KELLY SUTHERLIN McLEOD ARCHITECTURE, INC. 3827 Long Beach Blvd. Long Beach, CA 90807 562.427.6697 tel 562.427.0327 fax ksm@ksmarchitecture.com www.ksmarchitecture.com	SHEET REVISIONS	DATE
House and New ADU Door Schedule	PROJECT / SUBMITTALS ISSUES / SUBMITTALS PRE-APPLICATION ADMIN PERMITS ADMIN PERMITS EXEMPTION APP. REV. 1 EXEMPTION APP. REV. 2 DESIGN REVIEW APP.	1/25/20 2/25/20 09/04/21 03/29/21 04/27/21 04/27/21
KEEGAN RESIDENCE 1622 Ard Eevin Avenue Glendale, Ca 91202	Date	07/22/2021
Drawn KSM ARCHITECTURE, INC.	Job	-
Sheet A-7.0	Date	07/22/2021

WINDOW SCHEDULE

WINDOW NUMBER	ROOM NAME	TYPE	NEW OR EXISTING		FRAME SIZE AND HEIGHT		FRAME		VISIBLE FROM STREET (Y/N)	E) OPERATION	N) OPERATION	FRAME TYPE	EXTERNAL GRID OR SDL	E) SILL & FRAME	N) SILL & FRAME	E) EDGE DETAIL	N) EDGE DETAIL	BEDROOM	ENERGY EFFICIENT	TEMPERED	FIRE HAZARD ZONE	WINDOW WITHIN 18" OF FLOOR OR 40" OF DOOR
			E)	N)	E)	N)	E)	N)														

HOUSE FIRST FLOOR

101	DINING ROOM	A	(E)	36" X 60"	WOOD	NA	WOOD	NA	Y	CASEMENT	NA	BLOCK	NA	Y	N	WOOD MOULDING	NA	N	NA	NA	Y	NA
102		B		18" X 60"																		
103	LIVING ROOM	A	(E)	36" X 60"	WOOD	NA	WOOD	NA	Y	CASEMENT	NA	BLOCK	NA	Y	N	WOOD MOULDING	WOOD MOULDING	Y	NA	NA	Y	NA
104		B		18" X 60"																		
105		A	(E)	36" X 60"	WOOD	NA	WOOD	NA	Y	CASEMENT	NA	BLOCK	NA	Y	N	WOOD MOULDING	WOOD MOULDING	Y	NA	NA	Y	NA
106		B		18" X 60"																		
107		A	(E)	36" X 60"	WOOD	NA	WOOD	NA	Y	CASEMENT	NA	BLOCK	NA	Y	N	WOOD MOULDING	WOOD MOULDING	Y	NA	NA	Y	NA
108	STUDY	F	(N)	48" X 48"	WOOD	NA	WOOD	NA	Y	CASEMENT	NA	BLOCK	NA	Y	N	WOOD MOULDING	WOOD MOULDING	Y	NA	NA	Y	NA
109		H		36" X 40"																		
110	KITCHEN	G	(E)	24" X 40"	WOOD	NA	WOOD	NA	Y	CASEMENT	NA	BLOCK	NA	Y	N	WOOD MOULDING	WOOD MOULDING	Y	NA	NA	Y	NA
111		A	(E)	36" X 59"	WOOD	NA	WOOD	NA	Y	CASEMENT	NA	BLOCK	NA	Y	N	WOOD MOULDING	WOOD MOULDING	Y	NA	NA	Y	NA
112																						
113																						

HOUSE SECOND FLOOR

201	BEDROOM 2	C	(E)	36" X 59"	WOOD	NA	WOOD	NA	Y	DOUBLE HUNG	NA	BLOCK	NA	Y	N	WOOD MOULDING	NA	Y	NA	NA	Y	NA
202		B		18" X 59"						CASEMENT												
203	BEDROOM 1	E	(N)	41" X 17"					Y	SLIDING												
204	BATH 1	D		12" X 17"					Y	FIXED												
205		E		42" X 17"					Y	SLIDING												
206	CLOSET	I	(N)	36" X 53"	WOOD	NA	WOOD	NA	Y	DOUBLE HUNG	NA	BLOCK	NA	Y	N	WOOD MOULDING	WOOD MOULDING	Y	NA	NA	Y	NA
207	BATH 2	C	(E)	36" X 59"	WOOD	NA	WOOD	NA	Y	DOUBLE HUNG	NA	BLOCK	NA	Y	N	WOOD MOULDING	WOOD MOULDING	Y	NA	NA	Y	NA
208	BEDROOM 3	D		12" X 17"					Y	FIXED												
209		B		36" X 59"					Y	CASEMENT												
210		A	(E)	36" X 59"	WOOD	NA	WOOD	NA	Y	DOUBLE HUNG	NA	BLOCK	NA	Y	N	WOOD MOULDING	WOOD MOULDING	Y	NA	NA	Y	NA
211																						
212	BEDROOM 2																					
213																						

ADU FIRST FLOOR

116	BEDROOM	I	(N)	36" X 53"	WOOD	NA	WOOD	NA	Y	DOUBLE HUNG	NA	BLOCK	NA	Y	N	WOOD MOULDING	WOOD MOULDING	Y	NA	NA	Y	NA
117																						
118																						
119																						
20																						
21																						
22	FAMILY ROOM	I	(N)	36" X 53"	WOOD	NA	WOOD	NA	Y	DOUBLE HUNG	NA	BLOCK	NA	Y	N	WOOD MOULDING	WOOD MOULDING	Y	NA	NA	Y	NA
23																						
24																						
25																						

WINDOW NOTES FOR MANUFACTURER AND CONTRACTOR:

- ORDER TO BE SUBMITTED FOR REVIEW TO ARCHITECT PRIOR TO PLACEMENT. ALL DIMENSIONS TO BE CONFIRMED WITH MANUFACTURER'S DETAILS.
- DIMENSIONS OF ALL EXISTING AND NEW WINDOW OPENINGS TO BE CONFIRMED ON-SITE BY CONTRACTOR PRIOR TO ORDERING.
- ALL SIZES LISTED FOR NEW WINDOWS ARE OUTSIDE DIMENSION OF UNIT/INSIDE OF FRAME.
- EGRESS WINDOW SHALL HAVE A MINIMUM NET CLEAR OPENABLE AREA OF 5.7 SQUARE FEET. THE MINIMUM NET CLEAR OPENABLE HEIGHT SHALL BE 24 INCHES AND THE MINIMUM NET CLEAR OPENABLE WIDTH SHALL BE 20 INCHES. THE WINDOWS SHALL HAVE A FINISHED SILL HEIGHT NOT MORE THAN 44 INCHES ABOVE THE FLOOR.
- ALL TEMPERED GLASS AT WINDOWS AND DOORS TO BE WITHOUT VISIBLE MARKINGS AFTER INSTALLATION. CERTIFICATES FOR TEMPERING TO BE AVAILABLE ON-SITE FOR INSPECTOR AND THEN DELIVERED TO OWNER. CONTRACTOR TO VERIFY WITH CITY INSPECTOR.
- SAFETY GLAZING TO BE INSTALLED. (PER CBC SECTIONS 2406.3 & 2406.4) SEE NOTE 2, ABOVE.

WINDOW TYPES

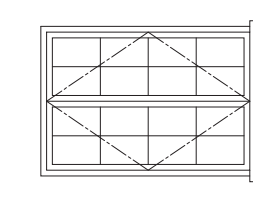
A EXISTING PAIRED CASEMENT WINDOW 

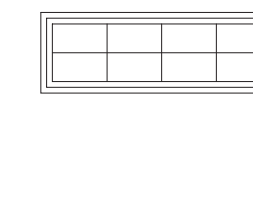
B EXISTING SINGLE CASEMENT WINDOW 

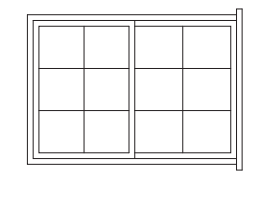
C EXISTING DOUBLE HUNG WINDOW 

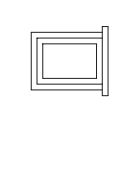
D EXISTING FIXED WINDOW 

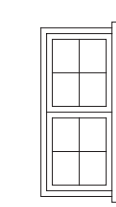
E EXISTING SLIDING WINDOW 

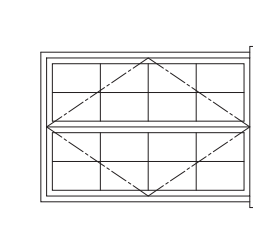
F NEW PAIRED CASEMENT WINDOW 

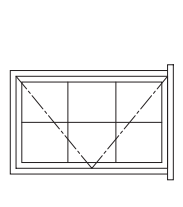
G NEW SINGLE CASEMENT WINDOW 

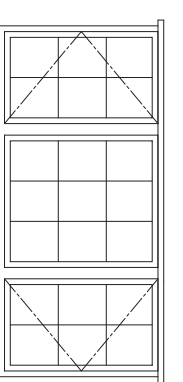
H NEW FIXED WINDOW WITH CASEMENT ON EACH SIDE 

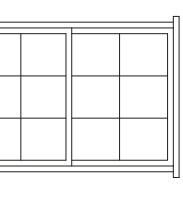
I NEW DOUBLE HUNG WINDOW 

- Note:
- ALL DOORS & WINDOWS SHALL MEET CITY OF GLENDALE'S SECURITY ORDINANCE.
 - ALL NEW WINDOWS SHOULD BE TEMP. GLASS.

WINDOW HARDWARE LEGEND

STYLE NUMBER	ITEM	MANUFACTURER	STYLE	MODEL NUMBER	FINISH AND/OR COLOR	REMARKS
I	T.B.D.	T.B.D.	T.B.D.		WHITE	FOR CASEMENT WINDOWS

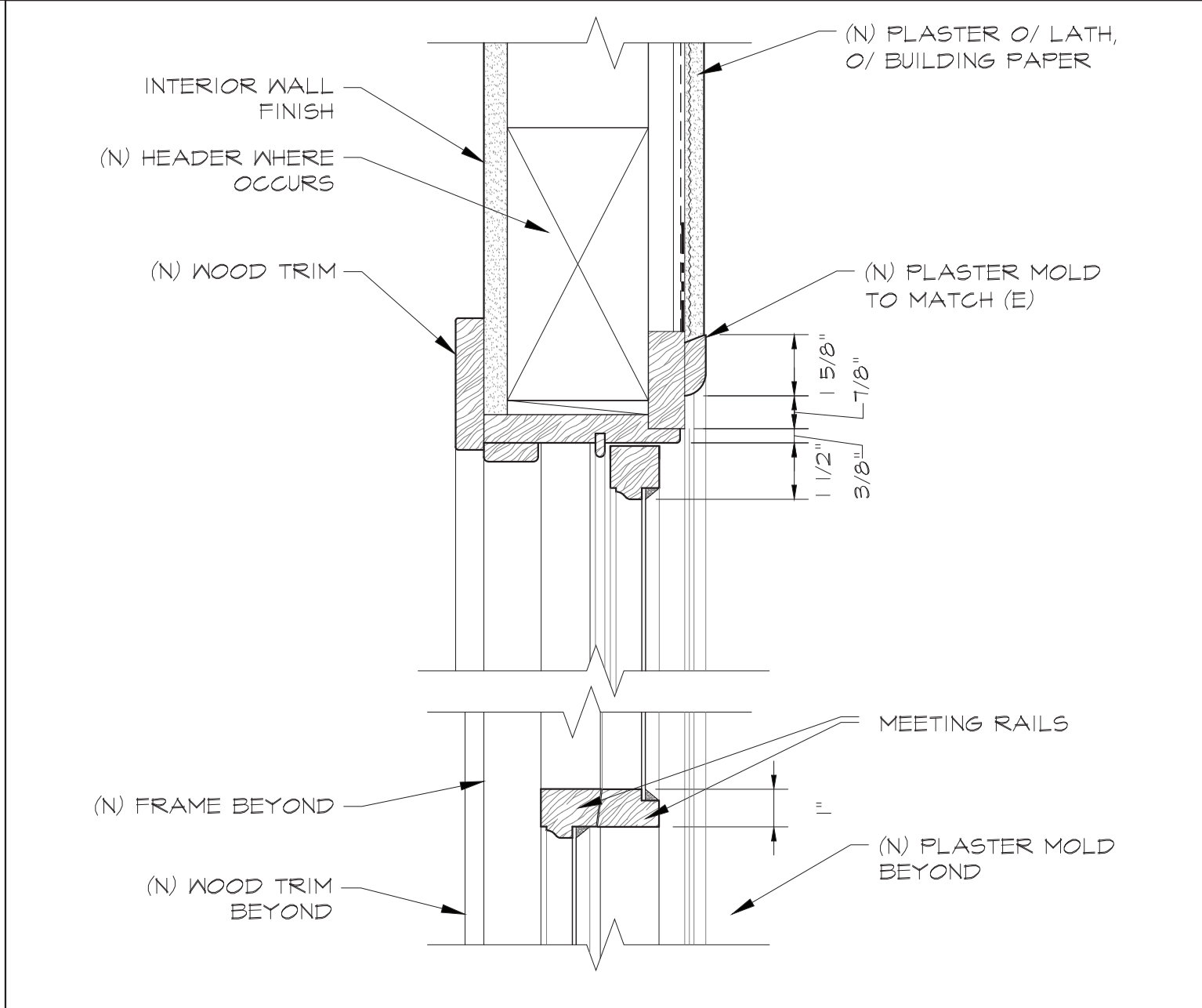

9 NEW DOUBLE HUNG WINDOW HEAD TYP. SCALE: 3"=1'-0"

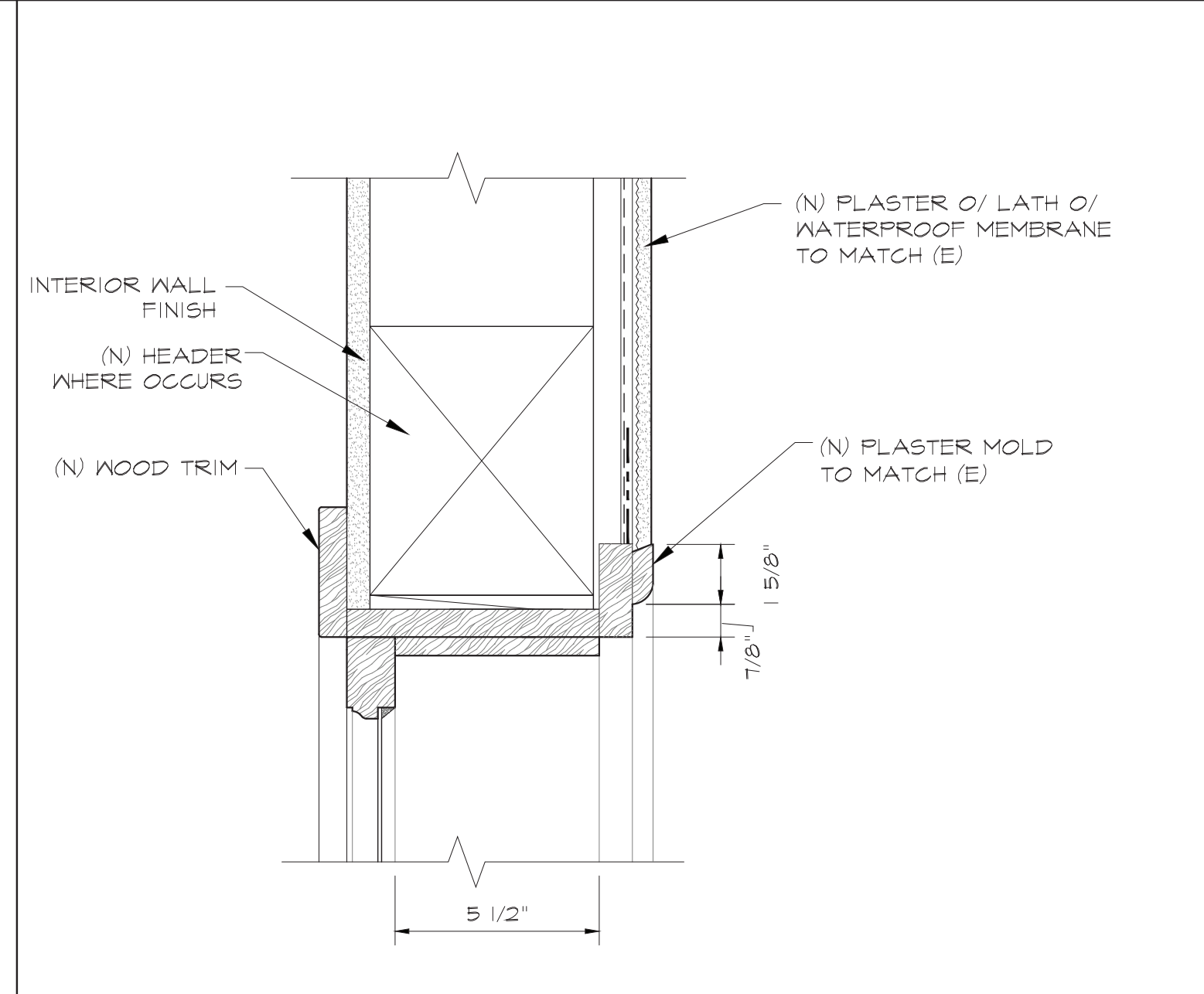

6 NEW CASEMENT WINDOW HEAD TYP. SCALE: 3"=1'-0"

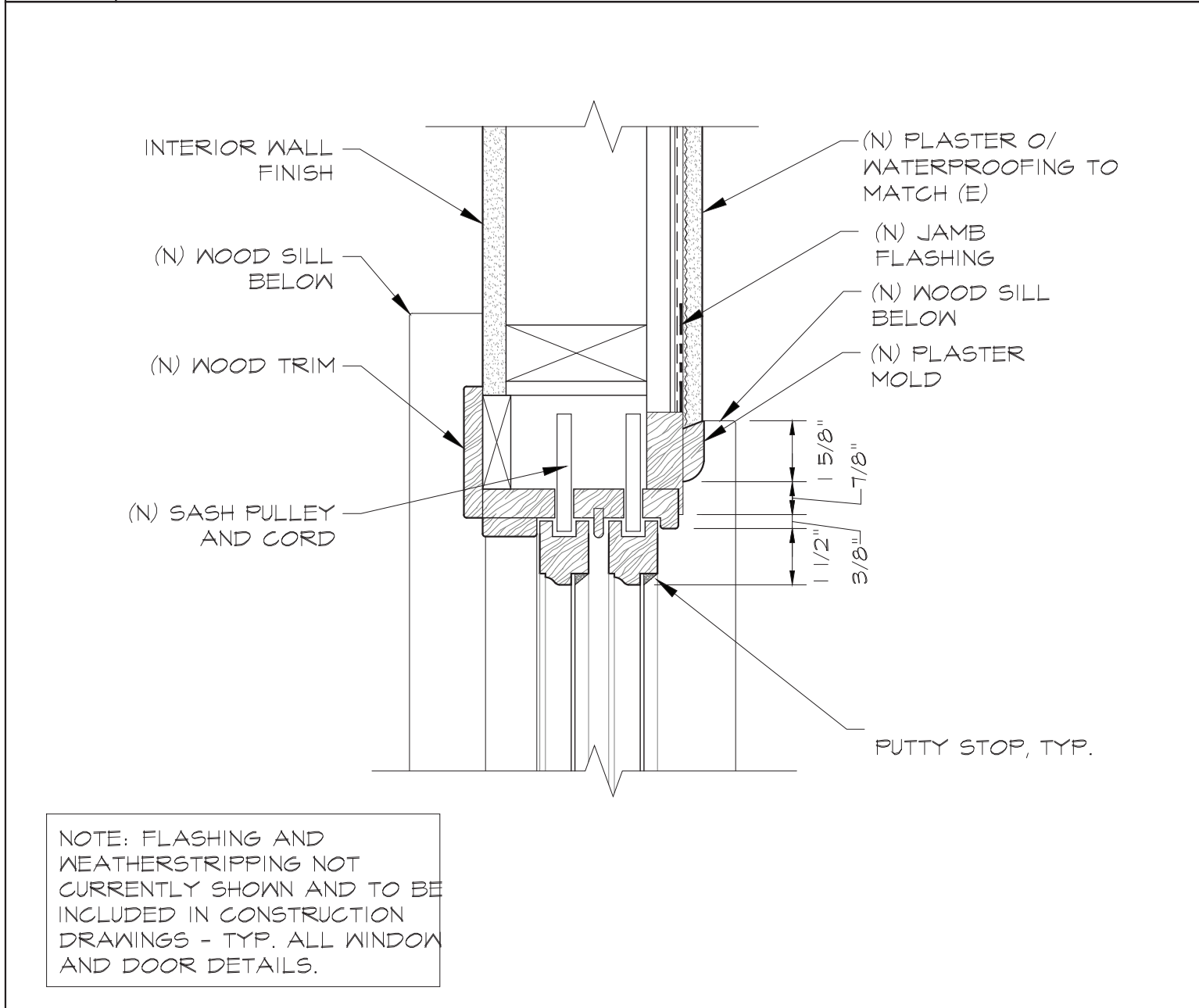

8 NEW DOUBLE HUNG WINDOW JAMB TYP. SCALE: 3"=1'-0"

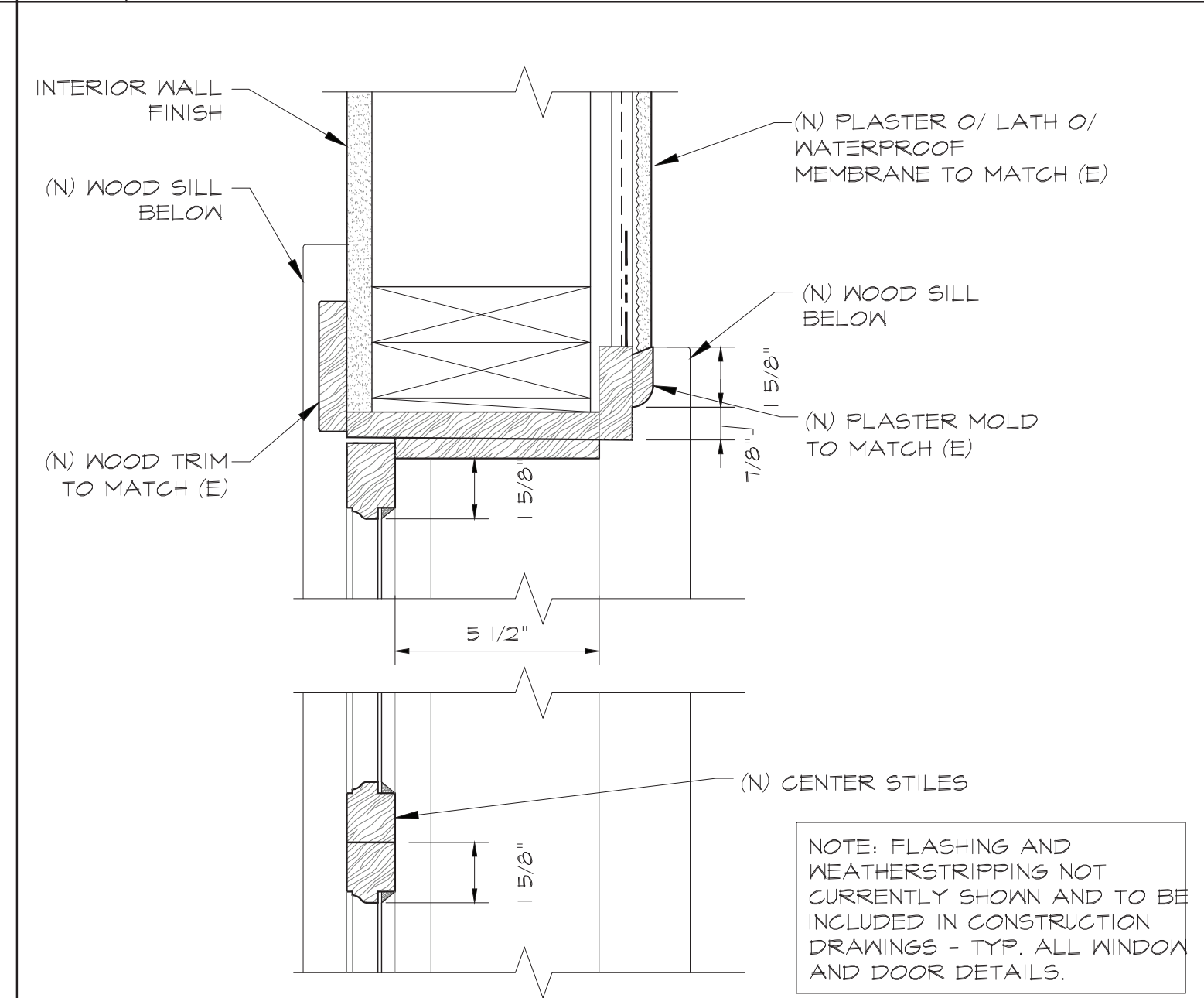

5 NEW CASEMENT WINDOW JAMB TYP. SCALE: 3"=1'-0"

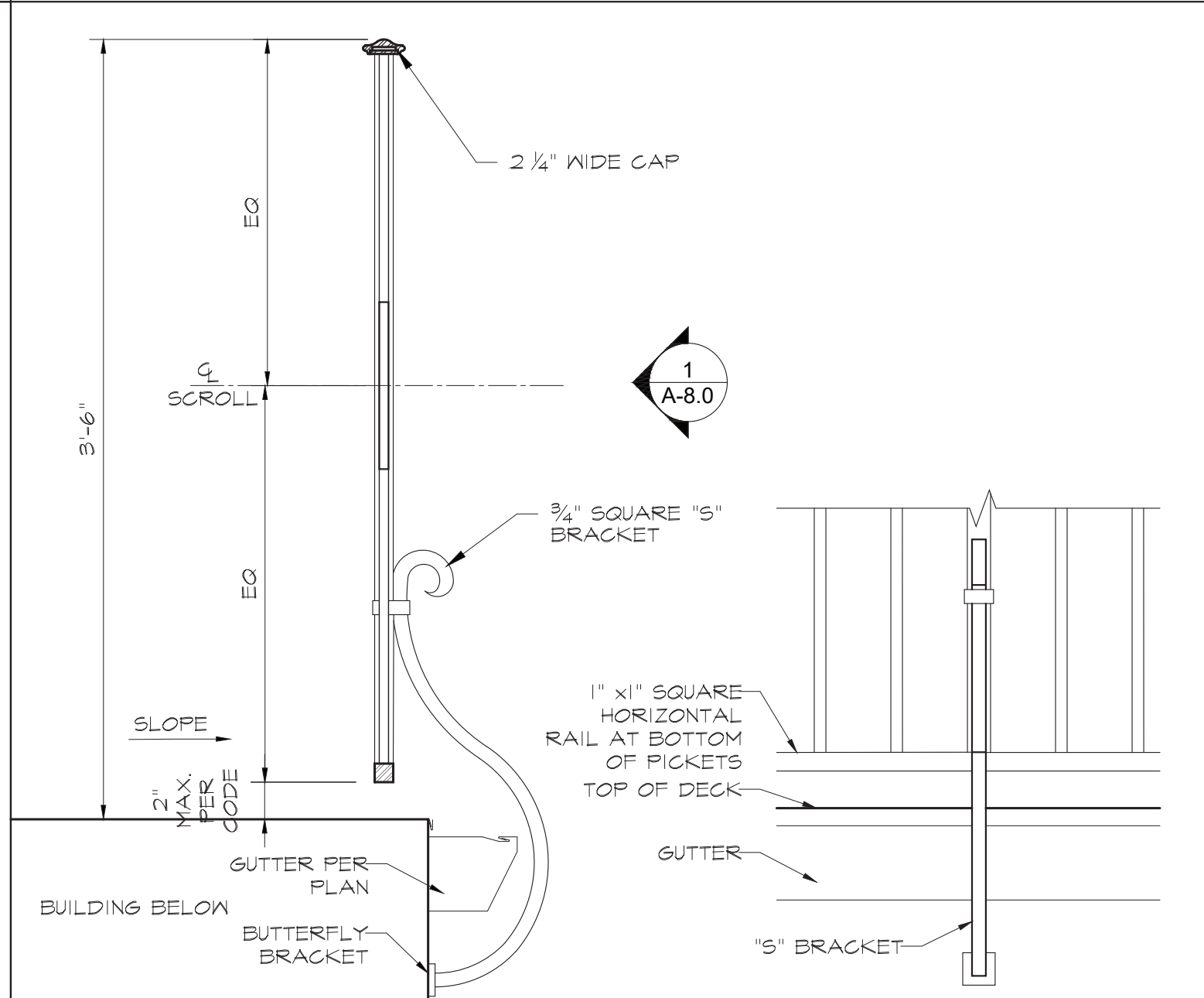

2 Iron Guardrail Section & Elevation Concept SCALE: 1 1/2"=1'-0"

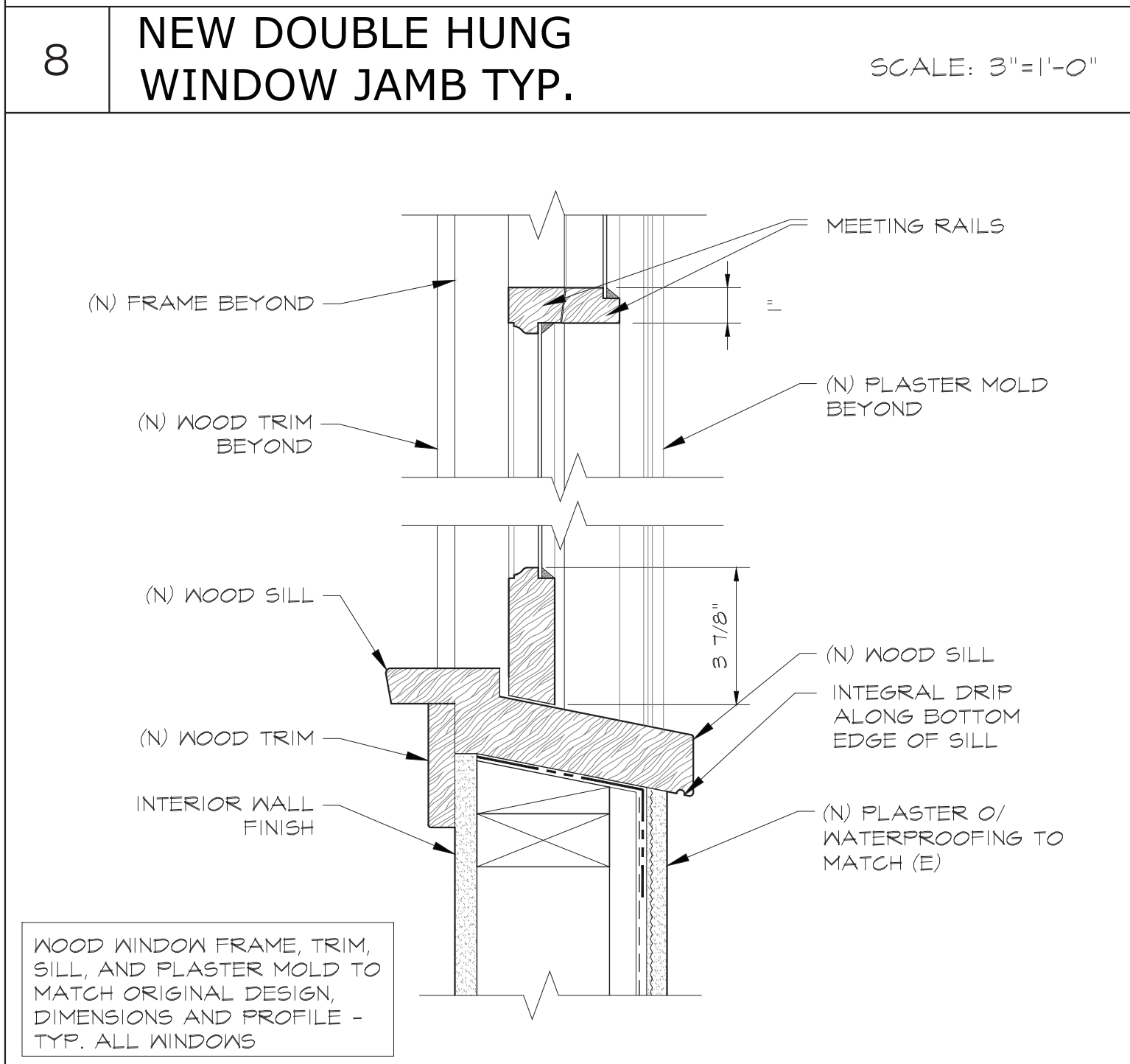

7 NEW DOUBLE HUNG WINDOW SILL TYP. SCALE: 3"=1'-0"

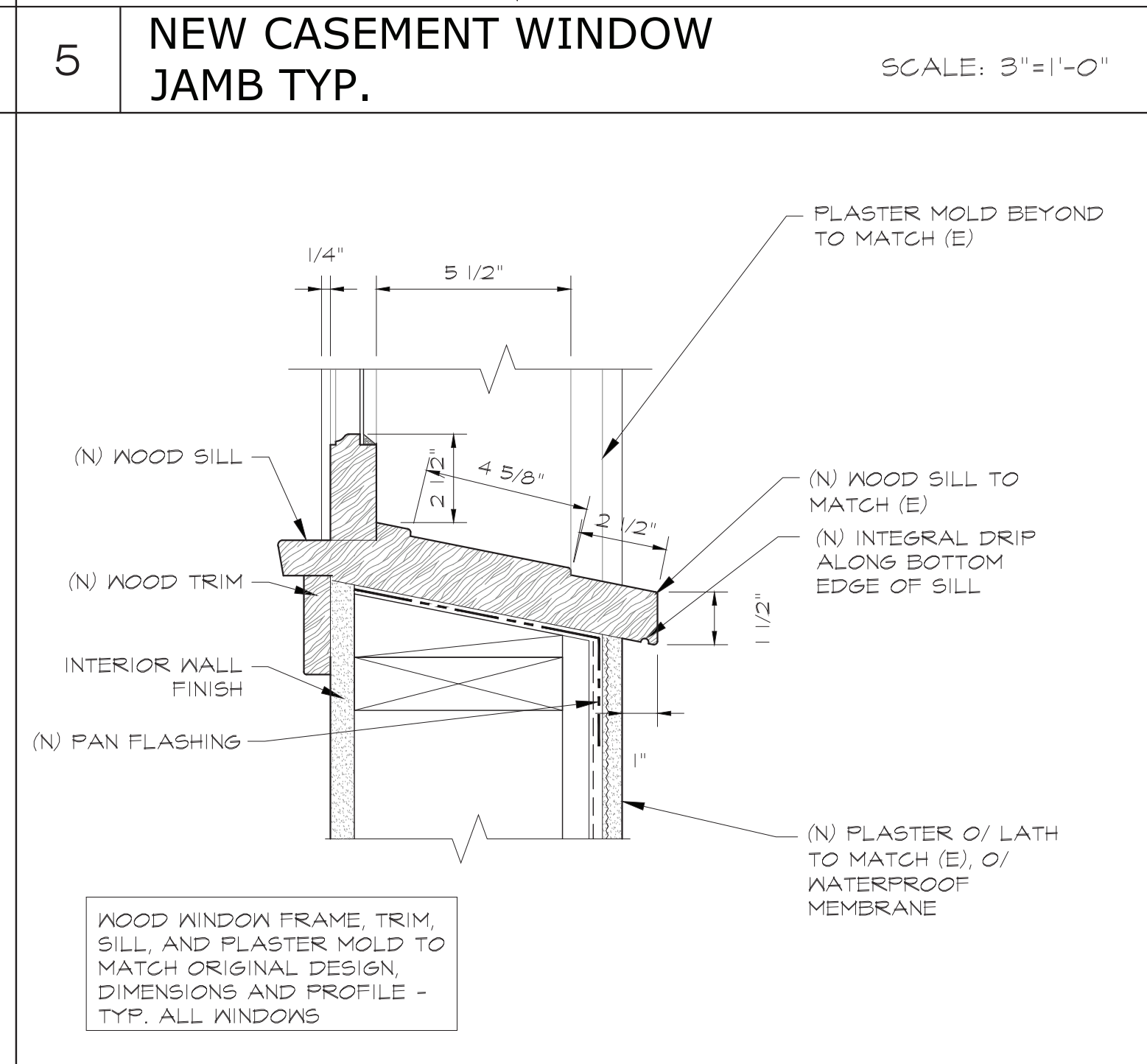

4 NEW CASEMENT WINDOW SILL TYP. SCALE: 3"=1'-0"

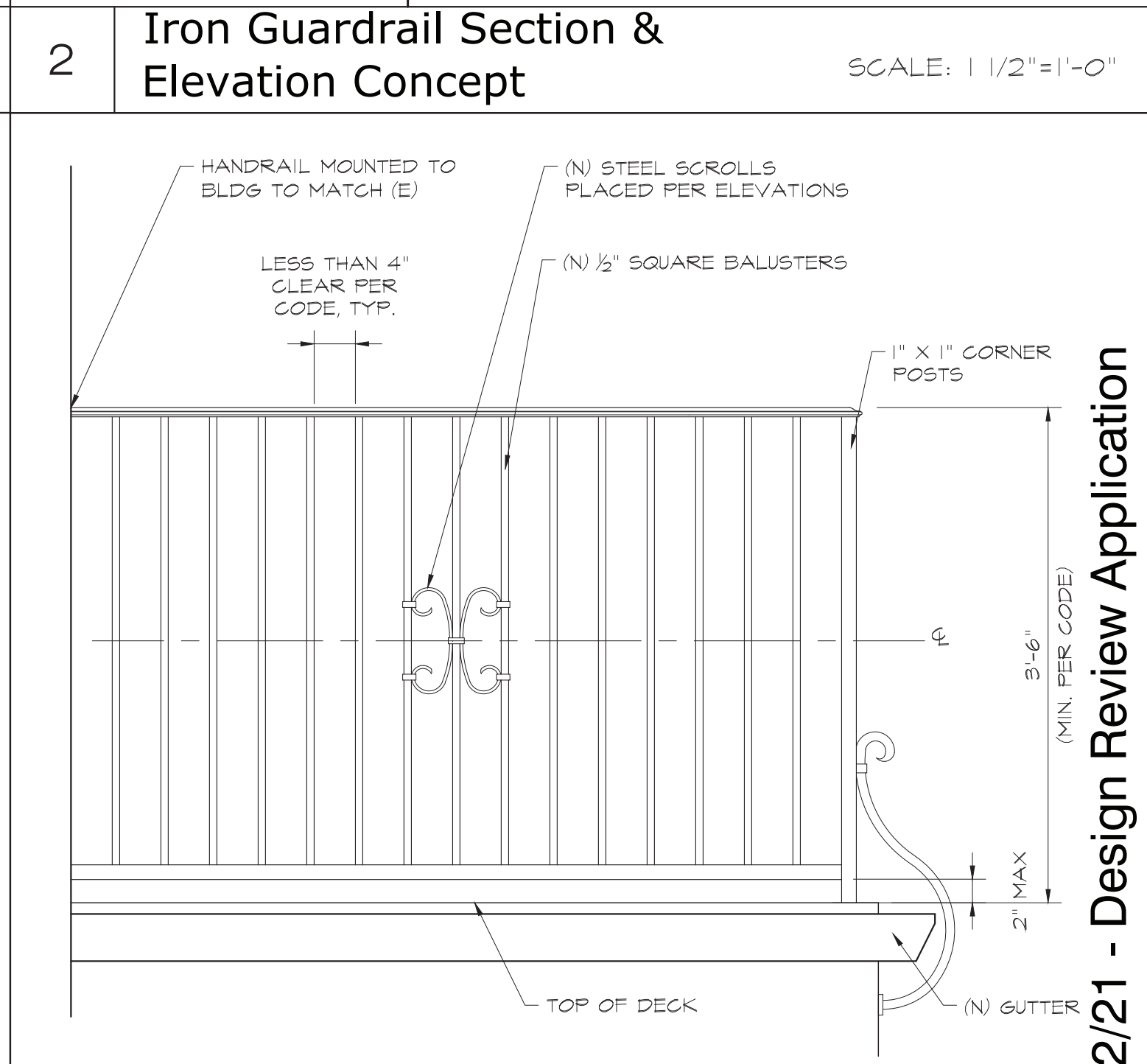

1 GUARDRAIL ELEVATION SCALE: 1"=1'-0"

NOTE: FLASHING AND WEATHERSTRIPPING NOT CURRENTLY SHOWN AND TO BE INCLUDED IN CONSTRUCTION DRAWINGS - TYP. ALL WINDOW AND DOOR DETAILS.

NOTE: FLASHING AND WEATHERSTRIPPING NOT CURRENTLY SHOWN AND TO BE INCLUDED IN CONSTRUCTION DRAWINGS - TYP. ALL WINDOW AND DOOR DETAILS.

WOOD WINDOW FRAME, TRIM, SILL, AND PLASTER MOLD TO MATCH ORIGINAL DESIGN, DIMENSIONS AND PROFILE - TYP. ALL WINDOWS

WOOD WINDOW FRAME, TRIM, SILL, AND PLASTER MOLD TO MATCH ORIGINAL DESIGN, DIMENSIONS AND PROFILE - TYP. ALL WINDOWS

PROJECT / SUBMITTALS	DATE
ISSUES / SUBMITTALS	1/25/20
PRE-APPLICATION	2/23/20
ADMINISTRATIVE	03/04/21
ADMINISTRATIVE	03/24/21
ADMINISTRATIVE	04/27/21
EXEMPTION APP. REV. 2	04/27/21
DESIGN REVIEW APP.	04/27/21

KEEGAN RESIDENCE
1622 Ard Evin Avenue
Glendale, Ca 91202

Date: 07/22/2021
Drawn: KSM ARCHITECTURE, INC.
Job:
Sheet:

A-8.0

07/22/21 - Design Review Application

KELLY SUTHERLIN McLEOD
ARCHITECTURE, INC.
3827 Long Beach Blvd. | Long Beach, CA 90807
562-427-6697 tel | 562-427-0527 fax
ksm@ksmarchitecture.com | www.ksmarchitecture.com

Details

DATE

SHEET REVISIONS



2 E) HISTORIC DOUBLE HUNG WINDOW SCALE: 1"=1'-0"

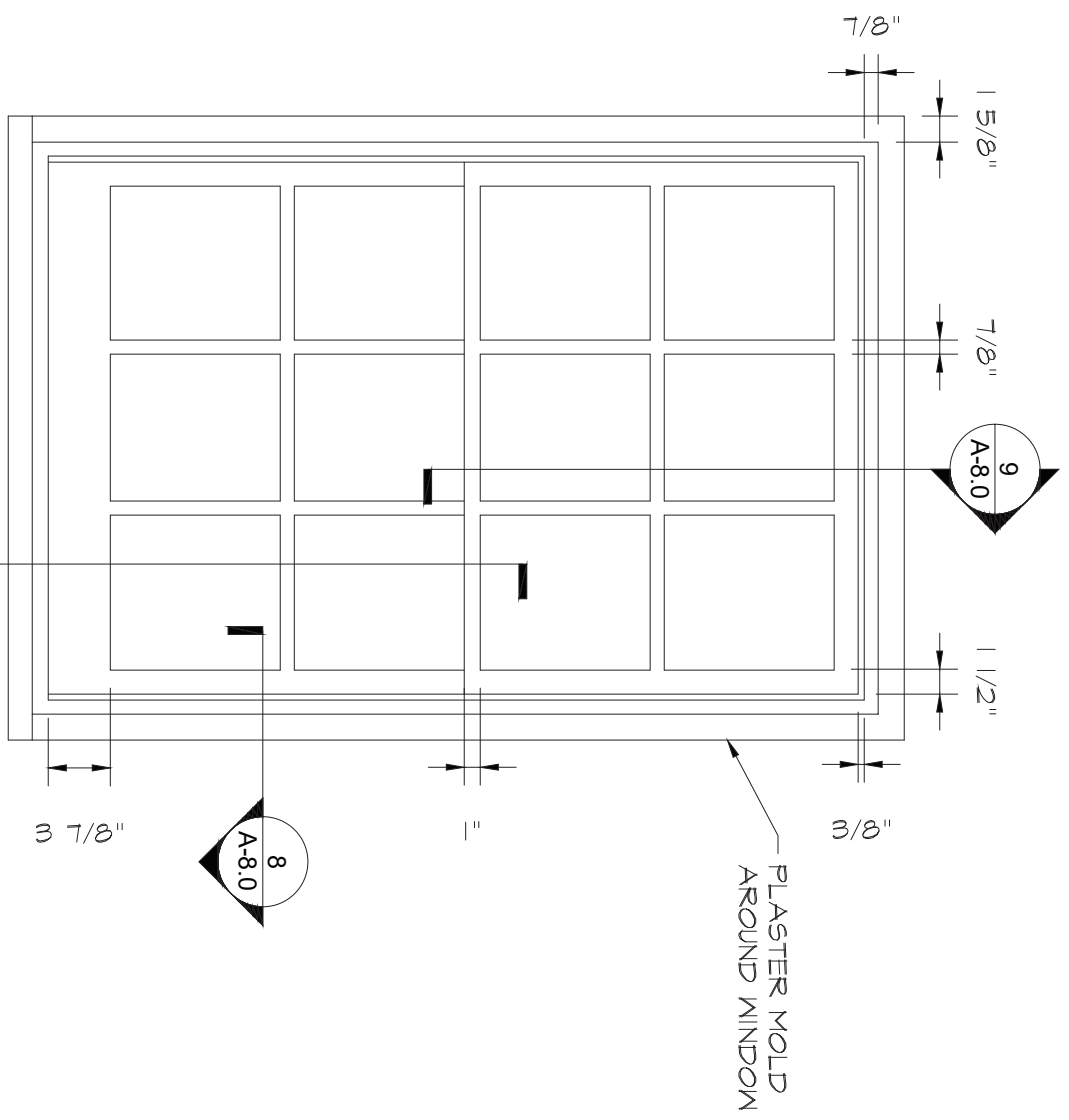

8 N) DOUBLE HUNG WINDOW # 208 & 209 SCALE: 1"=1'-0"

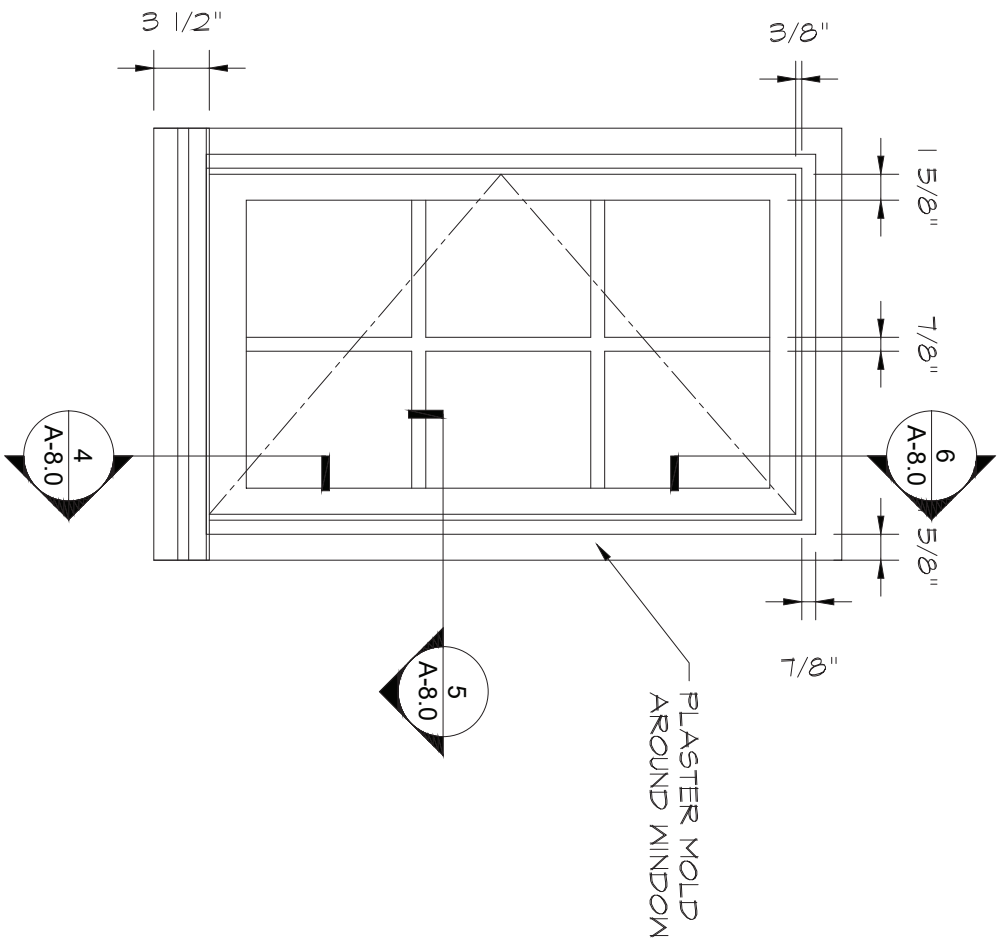

10 N) SINGLE CASEMENT WINDOW #113 SCALE: 1"=1'-0"

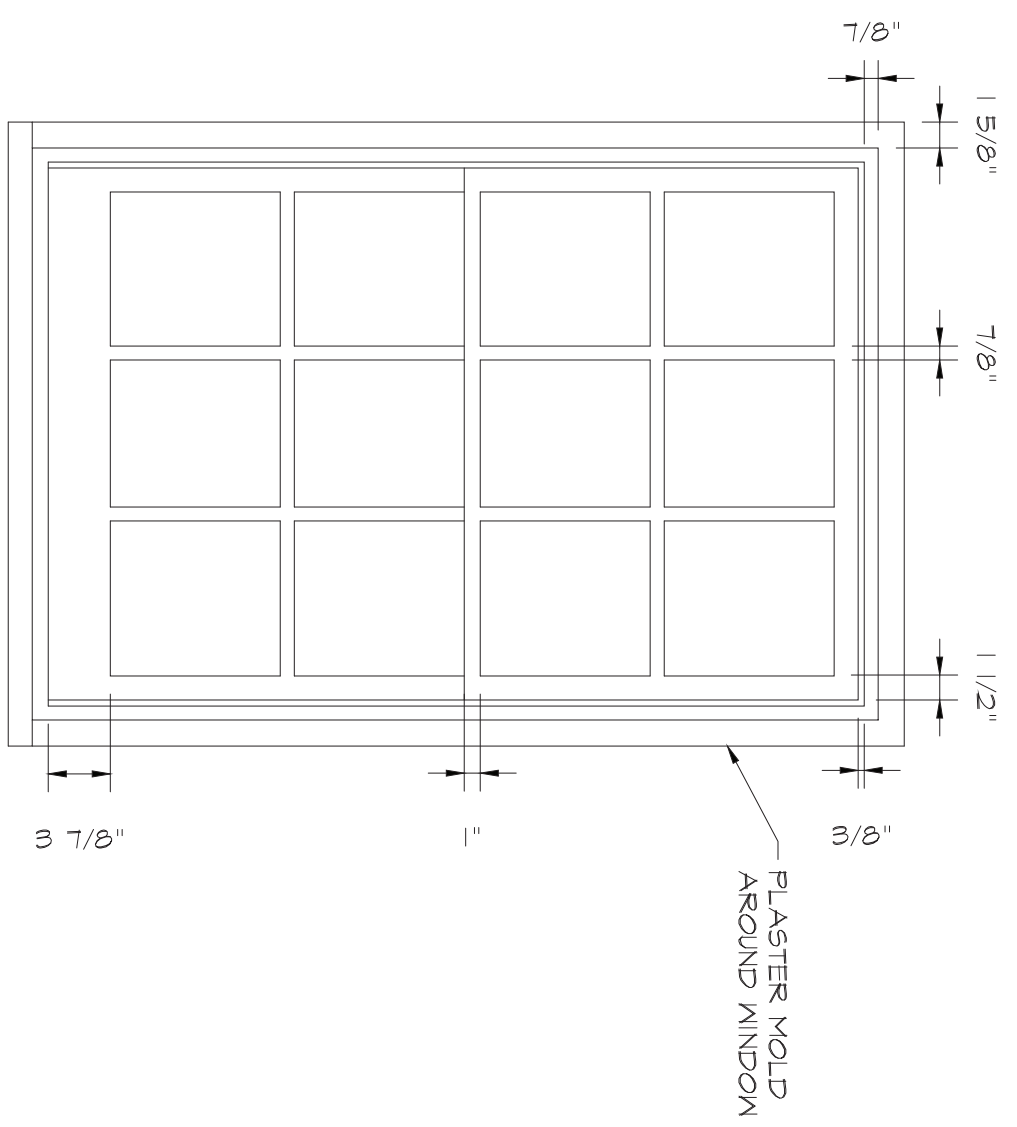

5 E) DOUBLE HUNG WINDOW SCALE: 1"=1'-0"

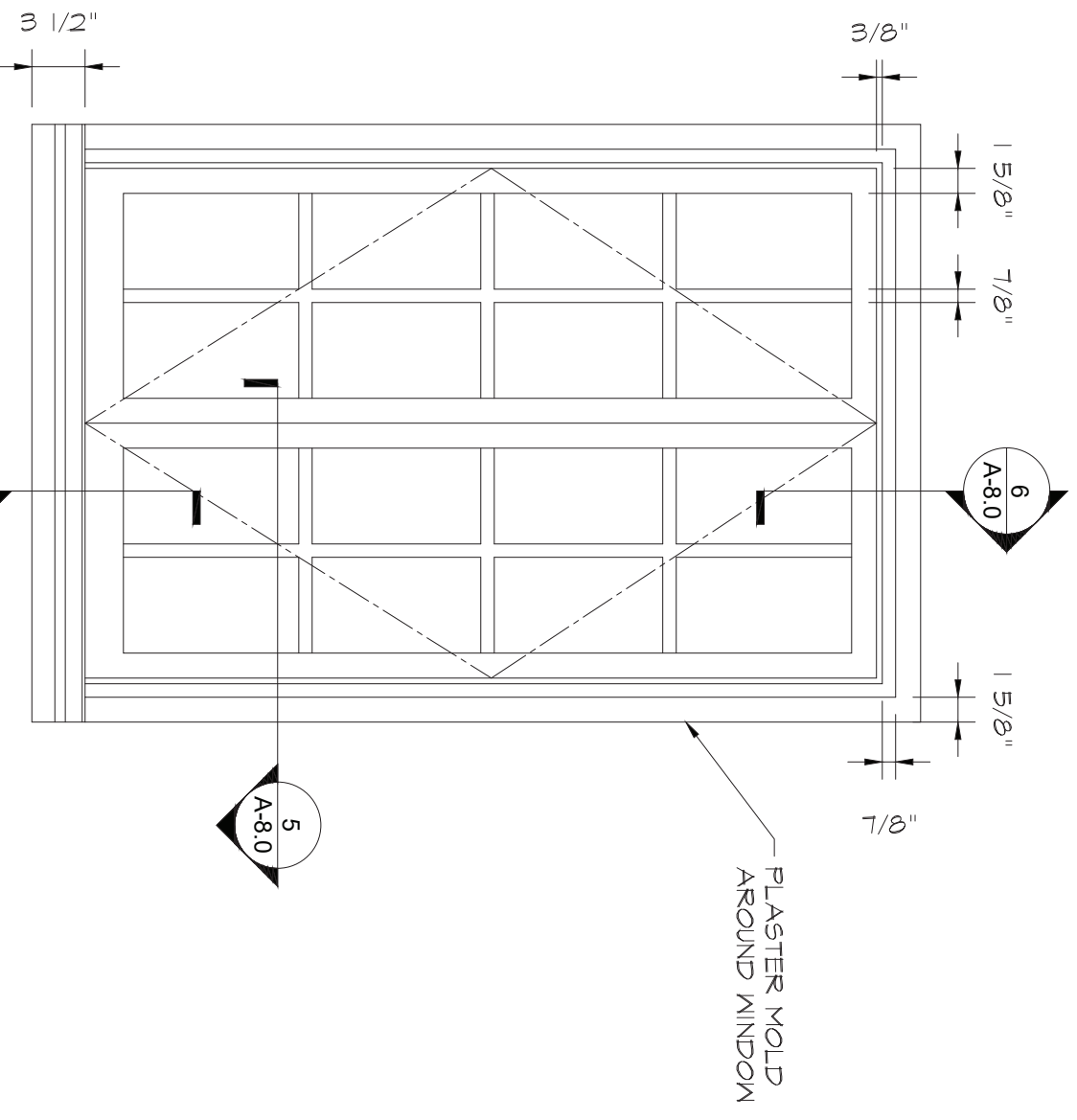

7 N) DOUBLE CASEMENT WINDOW #110 & 111 SCALE: 1"=1'-0"

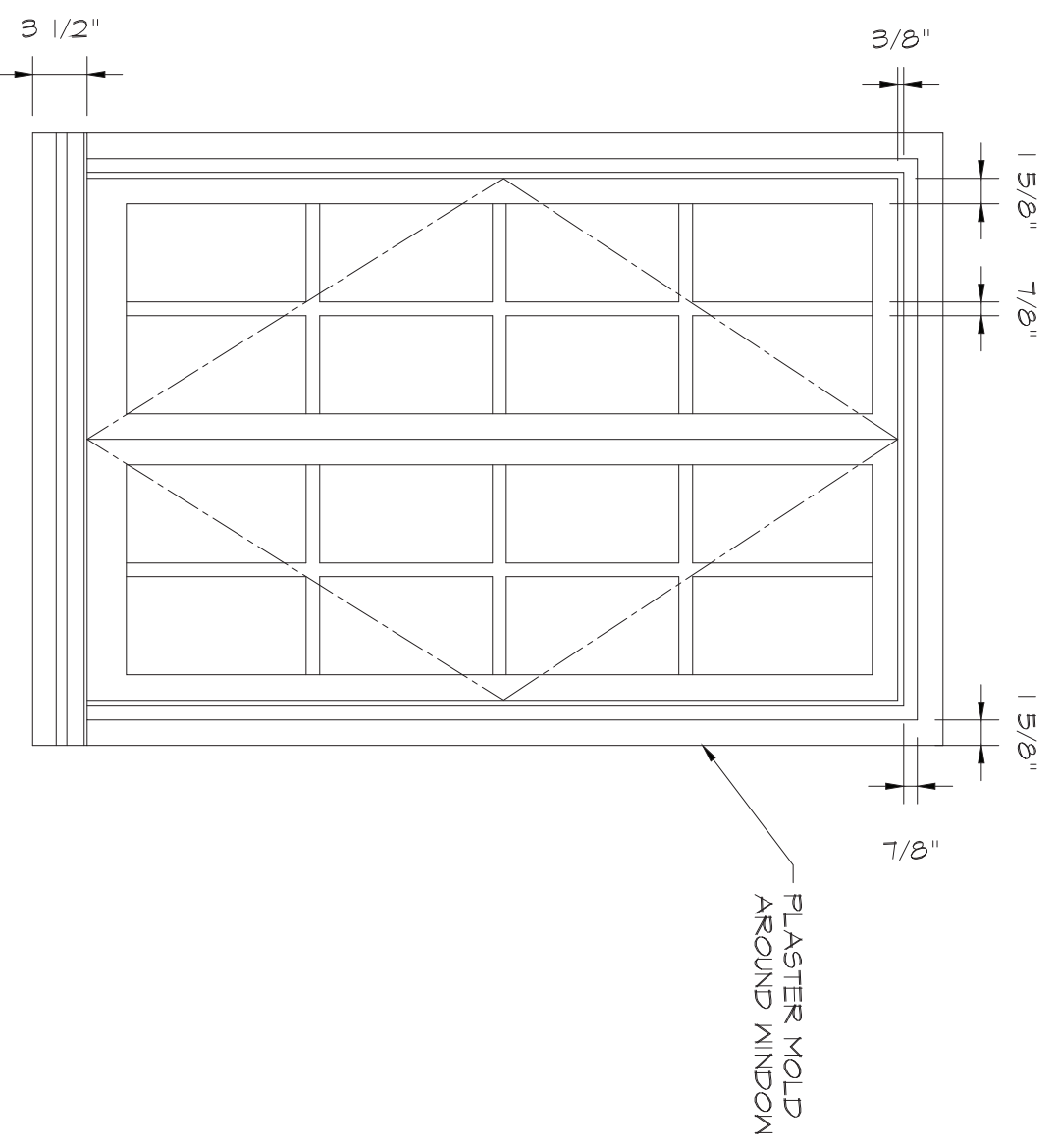

4 E) DOUBLE CASEMENT WINDOW SCALE: 1"=1'-0"



1 E) DOUBLE CASEMENT WINDOW TO BE REMOVED SCALE: 1"=1'-0"

07/22/21 - Design Review Application



A-1 Stucco and Existing Downspouts -
Color: Custom to match existing

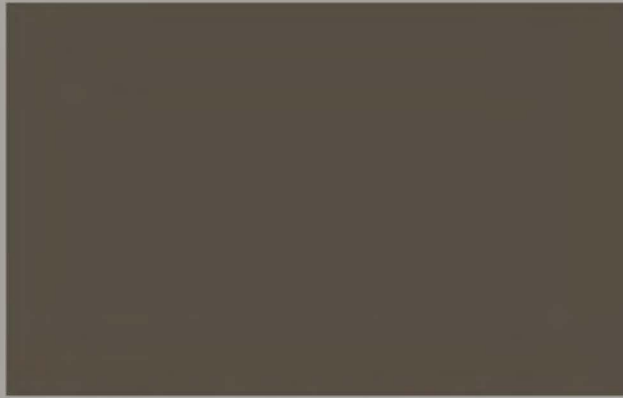

A-2 Window Trim, Door Trim and Eaves -
Color: Dunn Edwards *Weathered Brown*



A-3 Window Sashes and French Doors -
Color: Dunn Edwards *Dark Lagoon*



A-4 Exterior Sconces

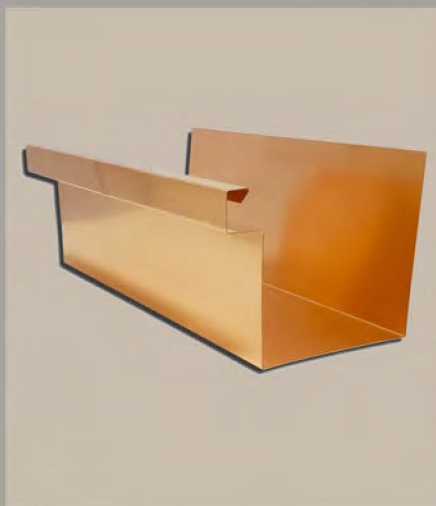

A-5 New Copper Gutters
and Downspouts



A-6 Wrought Iron
Handrail



A-7 Roof Tile - to match existing

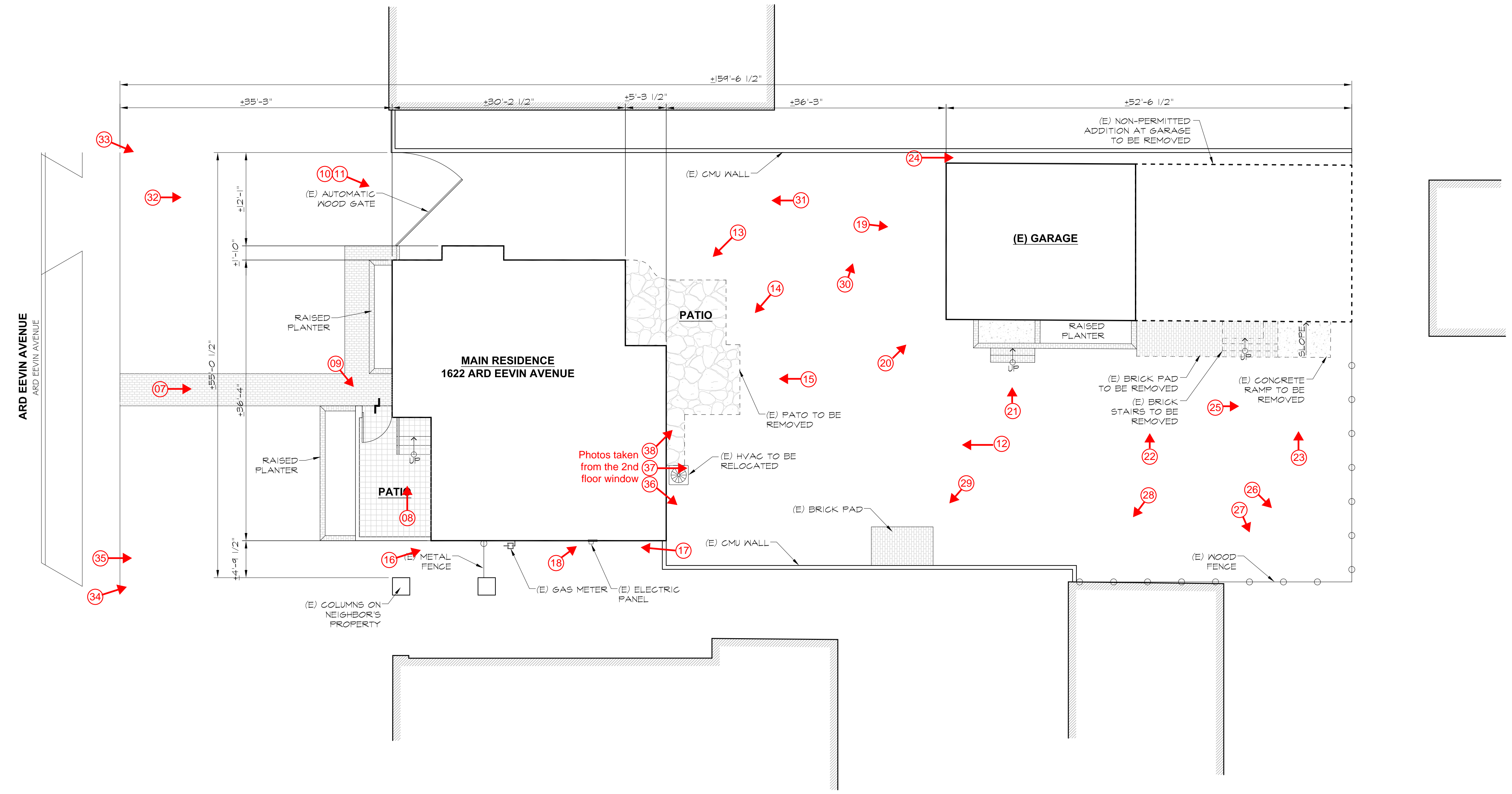

1 Plot Plan

Scale: 1/8" = 1'-0"

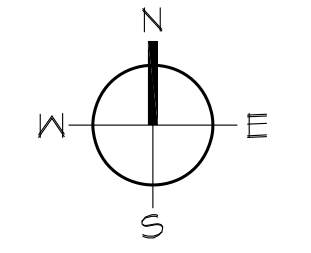

SHEET REVISIONS	DATE

KELLY SUTHERLIN McLEOD
 ARCHITECTURE, INC.
 3827 Long Beach Blvd. | Long Beach, CA 90807
 562.427.6697 tel | 562.427.0527 fax
 ksm@ksmarchitecture.com | www.ksmarchitecture.com

Plot Plan

PROJECT ISSUES / SUBMITTALS	DATE

KEEGAN RESIDENCE
 1622 Ard Eevin Avenue
 Glendale, Ca 91202

Date	10/20/2020
Drawn	KSM ARCHITECTURE, INC.
Job	-
Sheet	-

A-1.0

1622 Ard Eevin Ave. - House



07

1622 Ard Eevin_House_West Elevation_Looking East



08

1622 Ard Eevin_House_West Elevation_Looking North

1622 Ard Eevin Ave. - House



09

1622 Ard Eevin_House_West Elevation_Looking Southeast



10

1622 Ard Eevin_House_North Elevation_Looking Southeast_01

1622 Ard Eevin Ave. - House



11

1622 Ard Eevin_House_North Elevation_Looking Southeast_02



12

1622 Ard Eevin_House_East Elevation_Looking West_01

1622 Ard Eevin Ave. - House



13

1622 Ard Eevin_House_East Elevation_Looking West_02



14

1622 Ard Eevin_House_East Elevation_Looking Southwest

1622 Ard Eevin Ave. - House



15

1622 Ard Eevin_House_East Elevation_Looking West_03



16

1622 Ard Eevin_House_South Elevation_Looking East

1622 Ard Eevin Ave. - House



17

1622 Ard Eevin_House_South Elevation_Looking West



18

1622 Ard Eevin_House_South Elevation_Kitchen Window to be Removed

1622 Ard Eeven Ave. - Garage



19

1622 Ard Eevin_Garage_West Elevation



20

1622 Ard Eevin_Garage_Looking North East

1622 Ard Eeven Ave. - Garage



21

1622 Ard Eevin_Garage_South Elevation_01



22

1622 Ard Eevin_Garage_South Elevation_02

1622 Ard Eeven Ave. - Garage



23

1622 Ard Eevin_Garage_South Elevation_03



24

1622 Ard Eevin_Garage_North Elevation_Looking East

1622 Ard Eevin Ave. - Site



25

1622 Ard Eevin_Site_Looking East_02



26

1622 Ard Eevin_Site_Looking Southeast

1622 Ard Eevin Ave. - Site



27

1622 Ard Eevin_Site_Looking South_01



28

1622 Ard Eevin_Site_Looking South_02

1622 Ard Eevin Ave. - Site



29

1622 Ard Eevin_Site_Looking South_03



30

1622 Ard Eevin_Site_Looking North

1622 Ard Eevin Ave. - Site



31

1622 Ard Eevin_Site_Looking West



32

1622 Ard Eevin_Site_Looking East_01

1622 Ard Eevin Ave. - Site



33

1622 Ard Eevin_Site_Sidewalk_Looking Southeast



34

1622 Ard Eevin_Site_Sidewalk_Looking Northeast

1622 Ard Eevin Ave. - Site



35

1622 Ard Eevin_Site_Sidewalk_Looking East

1622 Ard Eeven Ave. - Second Floor Views



36

1622 Ard Eevin_2nd Floor_Looking South



37

1622 Ard Eevin_2nd Floor_Looking East

1622 Ard Eeven Ave. - Second Floor Views



38

1622 Ard Eevin_2nd Floor_Looking North

R1-1-HD

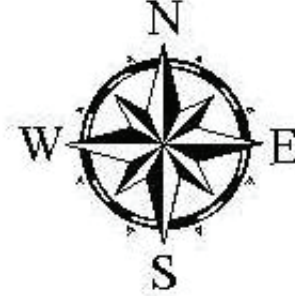

SCALE

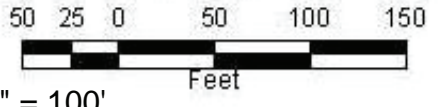

1" = 100'

Legend



Property

500' Radius

R1-1-HD

R1-1-HD

Keegan Residence
Administrative Exemption Application
1622 Ard Eevin Ave, Glendale Ca 91202
Submitted: 3/4/2021

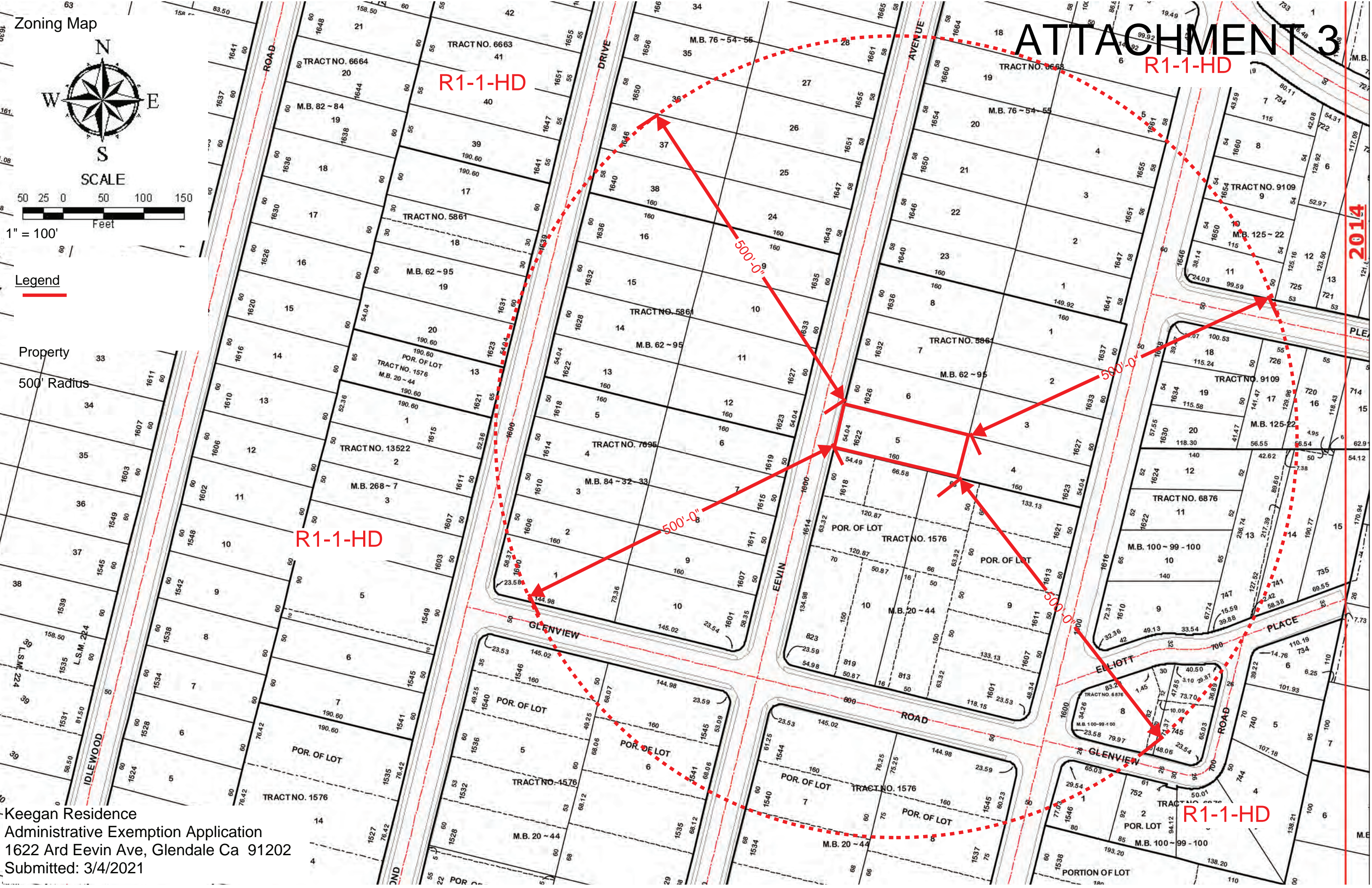

2014

Survey List: 1622 Ard Eevin Ave, Glendale CA



ATTACHMENT 4

Key	Address	Lot SF	Live SF	F/A%	Stories	Set Back	Roof	Historic District
Subject Property	1622 Ard Eevin Ave DRB#:	8,646	2,578	29.82%	2	35'-0"	Tile	Contributor
1	1601 Ard Eevin Ave	12,076	4,794	39.70%	2	29'-0"	Comp.	Non-contributor
2	1607 Ard Eevin Ave	8,153	1,834	22.49%	1	30'-04"	Tile	Contributor
3	1611 Ard Eevin Ave	8,161	1,934	23.70%	1	30'-11"	Comp.	Contributor
4	1615 Ard Eevin Ave	7,987	1,955	24.48%	1	25'-5"	Tile	Non-contributor
5	1619 Ard Eevin Ave	8,293	1,604	19.34%	1	27'-6"	Comp.	Contributor
6	1623 Ard Eevin Ave	8,739	2,952	33.78%	2	31'-7"	Tile	Contributor
7	1627 Ard Eevin Ave	9,646	2,570	26.64%	2	31'-4"	Tile	Contributor
8	1633 Ard Eevin Ave	9,510	2,385	25.08%	1	35'-1"	Tile	Contributor
9	1635 Ard Eevin Ave	9,806	2,856	29.13%	2	30'-10"	Tile	Contributor
10	1643 Ard Eevin Ave	9,231	3,717	40.27%	2	35'-8"	Tile	Non-contributor
11	1647 Ard Eevin Ave	9,367	2,135	22.79%	1	35'-1"	Tile	Non-contributor
12	1651 Ard Eevin Ave	9,280	1,726	18.60%	1	35'-0"	Comp.	Contributor
13	1650 Ard Eevin Ave	9,280	1,817	19.58%	1	38'-0"	Comp.	Contributor
14	1646 Ard Eevin Ave	9,136	2,536	27.76%	2	38'-2"	Comp.	Non-contributor
15	1640 Ard Eevin Ave	9,066	2,340	25.81%	2	36'-10"	Comp.	Contributor
16	1636 Ard Eevin Ave	9,735	1,663	17.08%	1	35'-8"	Comp.	Contributor
17	1632 Ard Eevin Ave	9,396	2,468	26.27%	2	35'-4"	Tile	Contributor
18	1626 Ard Eevin Ave	9,514	2,062	21.67%	1	34'-5"	Comp.	Contributor
19	1618 Ard Eevin Ave	11,242	2,137	27.76%	1	35'-6"	Tile	Contributor
20	1614 Ard Eevin Ave	11,733	2,450	20.88%	1	26'-10"	Tile	Contributor
21	823 Glenview Rd	10,163	1,624	15.98%	1	41'-0"	Tile	Not in District
22	1621 Highland Ave	6,579	1,765	26.83%	1	36'-0"	Tile	Contributor
23	1623 Highland Ave	8,341	1,977	23.70%	1	36'-4"	Tile	Contributor
24	1627 Highland Ave	9,600	2,708	28.21%	2	36'-0"	Comp.	Contributor
Neighborhood Average		9,002	2,334	25.31%	1.375	33'-2"		

Location Map



SCALE

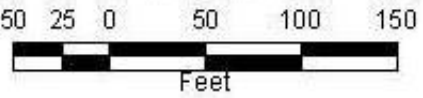

1" = 100'

Legend

- Property
- 300' radius

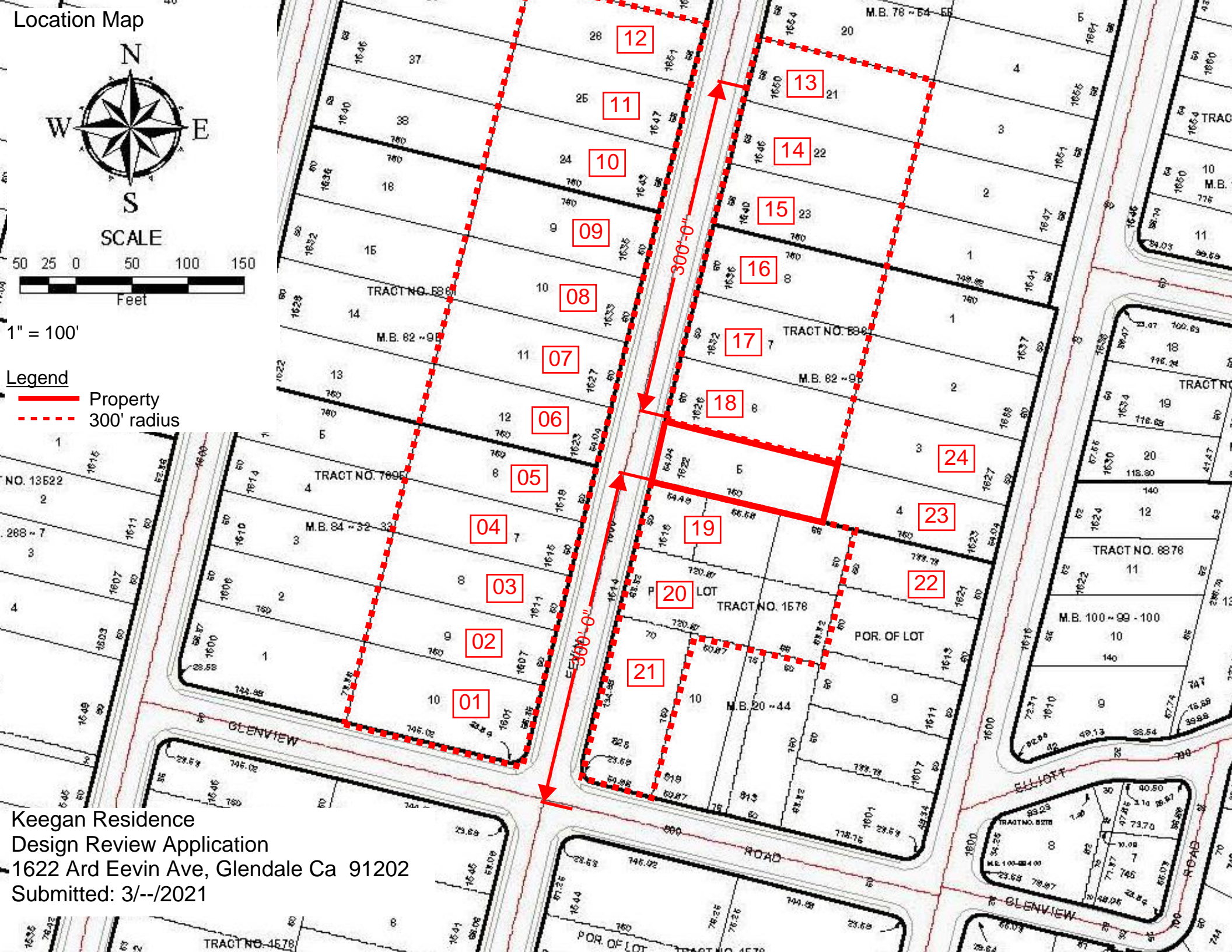

Keegan Residence
 Design Review Application
 1622 Ard Eevin Ave, Glendale Ca 91202
 Submitted: 3/--/2021

1622 Ard Eevin - Neighborhood Photos



00_1622 Ard Eevin



01_1601 Ard Eevin

1622 Ard Eevin - Neighborhood Photos



02_1607 Ard Eevin 1



03_1611 Ard Eevin 1

1622 Ard Eevin - Neighborhood Photos



04_1615 Ard Eevin 1



05_1619 Ard Eevin 2

1622 Ard Eevin - Neighborhood Photos



06_1623 Ard Eevin



07_1627 Ard Eevin 1

1622 Ard Eevin - Neighborhood Photos



08_1633 Ard Eevin



09_1635 Ard Eevin

1622 Ard Eevin - Neighborhood Photos



10_1643 Ard Eevin 2



11_1647 Ard Eevin 1

1622 Ard Eevin - Neighborhood Photos



12_1651 Ard Eevin Ave



13_1650 Ard Eevin Ave

1622 Ard Eevin - Neighborhood Photos



14_1646 Ard Eevin 1



15_1640 Ard Eevin 2

1622 Ard Eevin - Neighborhood Photos



16_1636 Ard Eevin



17_1632 Ard Eevin 2

1622 Ard Eevin - Neighborhood Photos



18_1626 Ard Eevin



19_1618 Ard Eevin

1622 Ard Eevin - Neighborhood Photos



20_1614 Ard Eevin 2



21_823 Glenview 1

1622 Ard Eevin - Neighborhood Photos



22_1621 Highland



23_1623 Highland

1622 Ard Eevin - Neighborhood Photos



24_1627 Highland Ave



August 18, 2021

Kelly Sutherlin
Kelly Sutherlin McLeod Architecture, Inc.
3827 Long Beach Blvd.
Long Beach, CA 90807

**RE: 1622 ARD EEVIN AVENUE
ADMINISTRATIVE EXCEPTION NO. PAE 2104358**

Ms. Sutherlin:

The Community Development Department has processed your application for an Administrative Exception pursuant to the provisions of the Glendale Municipal Code (GMC), Title 30, Chapter 30.44.020(E), to allow up to a 20% deviation from the interior setback standard (GMC 30.11.030) to allow a four-foot, one and a half inch (4'-1½") interior setback (existing) for a new two-story addition when Code requires a minimum five-foot setback for buildings greater than 20 feet in height (17.5% deviation).

The subject property is located at **1622 Ard Eevin Avenue**, in the Ard Eevin Highlands Historic District and "R1-I HD" Zone (Residential Zone, Floor Area Ratio District I with a Historic District Overlay Zone), and described as Tract Number 5861, Lot 5, in the City of Glendale, County of Los Angeles as per Map Recorded in Book 62, Page 93 of Maps in the Office of the County Recorder.

ENVIRONMENTAL DETERMINATION

This project is exempt from environmental review as a Class 1 "Existing Facilities" project per Section 15301 of the State CEQA Guidelines, since the project involves an addition that will not result in an increase of more than 50% of the floor area of the structure before the addition, or 2,500 square feet (SF), and as a Class 31 "Historic Restoration or Rehabilitation" exemption pursuant to Section 15331 of the State CEQA Guidelines because the project meets the Secretary of the Interior's Standards for Rehabilitation and the Historic District Design Guidelines.

REQUIRED/MANDATED FINDINGS

After considering the evidence presented with respect to this application, the plans submitted therewith, the Community Development Department has **GRANTED WITH CONDITIONS**, your application based on the following findings:

A. The granting of the exception will result in design improvements, or there are space restrictions on the site that preclude full compliance with the Code requirements without hardship.

The granting of the exception will result in design improvements, since setting the addition back further to meet the required setback would result in wall and roof jogs not consistent with the architectural style of this historic house.

The existing house is a 2,150 square-foot, two-story building in a Mediterranean Revival style, built in 1926 and recognized as a contributor to the Ard Eevin Highlands Historic District. The project involves a 428 SF two-story addition at the south-east corner of the building. The addition encroaches 10.5 inches into the required five-foot interior setback on the first story for a length of 11.5 feet and on the second story for a length of 6.5 feet, and includes a 198 SF second-floor deck on top of the first-floor addition. The addition and deck are located at the rear of the house and are only somewhat visible at the south façade. The south façade features a two-story wall, faced with smooth stucco and a mansard-style Spanish tile roof. If the addition were to be stepped back 10.5 inches from the existing façade to meet the required five-foot setback, instead of continuing the existing 4'-1½" setback, it would result in a jog in both the wall and roof that would appear unusual and inconsistent with the style of this house, which is important to maintain since it is a contributor to a historic district.

B. The granting of the exception, with any conditions imposed, will not be materially detrimental to the public welfare or injurious to the property or improvements in such zone or neighborhood in which the property is located.

Granting of the exception to allow a 4'-1½" setback, instead of a five-foot (5'-0") setback (10.5 inches or 17.5% deviation), for a two-story addition and second-floor deck, will not be materially detrimental to the public welfare or injurious to the property or improvements in such zone or neighborhood in which the property is located for the following reasons: 1) Preserving the existing setback to continue the wall surface and roof line of the existing building helps maintain the rectangular volume of the existing house which is characteristic of the Mediterranean Revival style; 2) The vertical reglet at the joint between the existing house and the addition represents the transition point between the two eras of construction; 3) The first floor addition involves removal of one window and reduction in size of a second window at the south-facing façade, which would reduce potential privacy impact to the neighbor and the proposed new window has been carefully designed to maintain the architectural features of the existing window; and 4) The second-story addition contains no windows, which prevents any related privacy issue in that area.

C. The granting of the exception will not be contrary to the objectives of the applicable regulations.

Approval of the Administrative Exception to allow a minor, 17.5% deviation in the interior setback standard for the two-story addition and second-floor deck will not be contrary to the objectives of the applicable regulation, which is to restrict the location of buildings, structures and land to protect residential areas from harmful encroachment by incompatible uses, and to provide adequate open spaces for light and air, etc. (GMC 30.01.020). The second floor addition encroaches 10.5 inches into the required five-foot setback for a distance of 6.5 feet; however, it contains no window openings, which prevents any encroachment by an incompatible activity and prevents privacy issues. Further, it is a minor extension of the existing building location which results in an insignificant change to the site's current configuration of open space that allows for light and air. The second floor deck, located on top of the first-floor addition, extends into the required setback 10.5 inches for a distance of five feet. Since the open wrought-iron railing along the edge of the deck is the only massing associated with it, it still allows light and air and minimizes the physical intrusion into the setback. Additionally, the deck handrail is set in from the building façade an additional 5.5 inches, further increasing the area between any deck activity and the required setback. For these reasons, granting the exception will not be contrary to the objectives of the applicable regulations.

CONDITIONS OF APPROVAL

APPROVAL of this Administrative Exception shall be subject to the following conditions:

- 1) That the development shall be in substantial accord with the plans presented in conjunction with the application for the Administrative Exception, except any modifications as may be required to meet specific Code standards or other conditions stipulated herein to the satisfaction of the Community Development Department.
- 2) That all necessary permits shall be obtained from the Building and Safety Section and all construction shall be in compliance with the Glendale Building Code and all other applicable regulations.
- 3) That design review approval or exemption shall be obtained prior to the issuance of a building permit.
- 4) That any expansion or modification of the dwelling unit which is different than what is represented as part of this Administrative Exception approval shall require a new application as determined by the Hearing Officer.

APPEAL PERIOD

The applicant's attention is called to the fact that this grant is not a permit or license and that any permits and licenses required by law must be obtained from the proper City and public agency.

Under the provisions of the Glendale Municipal Code, Title 30, Chapter 30.62, any person affected by the above decision has the right to appeal said decision to the Planning Commission if it is believed that the decision is in error or that procedural errors have occurred, or if there is substantial new evidence which could not have been reasonably presented. It is strongly advised that appeals be filed early during the appeal period and in person so that imperfections/incompleteness may be corrected before the appeal period expires. Any appeal must be filed on the prescribed forms within fifteen (15) days following the actual date of the decision. Information regarding appeals and appeal forms will be provided by the Permit Services Center (PSC) or the Community Development Department (CDD) upon request and must be filed with the prescribed fee prior to expiration of the 15-day period, on or before **SEPTEMBER 2, 2021**, at the Permit Services Center (PSC), 633 East Broadway, Room 101, Monday thru Friday 7:00 a.m. to 12:00 p.m., or at the Community Development Department (CDD), 633 East Broadway, Room 103, Monday thru Friday 12:00 p.m. to 5 p.m.

Due to the current COVID-19 social distancing and work from home orders issued by federal, state and local governmental agencies, in order for any appeal to be considered timely, the appeal must be postmarked by the **SEPTEMBER 2, 2021**, deadline (mailed to Community Development Department – Planning Division, 633 East Broadway, Room 103, Glendale, CA 91206) OR emailed to zoning@glendaleca.gov prior to the close of said business day. The prescribed fee must be included along with the appeal application and may be submitted either in the form of a check or credit card payment. For credit card payment, please contact Cassandra Pruet 818-937-8186 to make arrangements with the cashier. Note: the standard 2.5% fee for credit card payment applies.

APPEAL FORMS available on-line:

<https://www.glendaleca.gov/home/showdocument?id=11926>

TRANSFERABILITY

This authorization runs with the land or the use for which it was intended for and approved. In the event the property is to be sold, leased, rented or occupied by any person or corporation other than yourself, it is incumbent that you advise them regarding the conditions and/or limitations of this grant.

GMC CHAPTER 30.41 PROVIDES FOR

TERMINATION

Every right or privilege authorized by an Administrative Exception shall terminate two (2) years after the granting of such, unless the exercise of such right or privilege has commenced in good faith prior to such time, except as otherwise provided for.

CESSATION

An Administrative Exception may be terminated by the review authority upon any interruption or cessation of the use permitted by the Administrative Exception for one year or more in the continuous exercise in good faith of such right and privilege.

EXTENSION

Permits granted by such right or privilege may be requested one time and extended for up to a maximum of one (1) additional year upon receipt of a written request from the applicant and demonstration that a reasonable effort to act on such right and privilege has commenced within the two (2) years of the approval date. In granting such extension the applicable review authority shall make a written finding that neighborhood conditions have not substantially changed since the granting of the administrative exception.

VIOLATIONS OF THESE CONDITIONS

Violations of conditions required by this determination may constitute a misdemeanor or infraction under section 1.20.010 of the Glendale Municipal Code (GMC) and/or a violation of other local, State or Federal laws or regulations. Unless a specific penalty is provided, any person convicted of a misdemeanor shall be punished by a fine not to exceed one thousand dollars (\$1,000.00), or imprisonment for a term not to exceed six (6) months, or by both fine and imprisonment. Infractions are punishable by a fine not exceeding the sum of five hundred dollars (\$500.00) for each violation. Violations of conditions required by this determination may be grounds for a revocation.

REVOCAION

Section 30.64.020 – Revocation – The Community Development Department shall have continuing jurisdiction over Administrative Exceptions. To consider the revocation, the Director of Community Development shall hold a public hearing after giving notice by the same procedure as for consideration of a variance at least 10 days' notice by mail to the applicant or permittee.

NOTICE – subsequent contacts with this office

The applicant is further advised that all subsequent contacts with this office regarding this determination must be with the Case Planner first and then, the Hearing Officer who

acted on this case. This would include clarification, verification of condition compliance and plans or building permit applications, etc., and shall be accomplished **By Appointment Only**, in order to assure that you receive service with a minimum amount of waiting. You should advise any consultant representing you of this requirement as well.

You may contact the case planner, Cassandra Pruett, during normal business hours at (818) 937-8186 or via e-mail at cpruett@glendaleca.gov.

Sincerely,
Phillip Lanzafame
Director of Community Development



Erik Krause
Planning Hearing Officer

EK:CP:sm

cc: City Clerk (K.Cruz); Police Dept. (J.Newton/Z.Avila); City Attorney's Dept. (G. van Muyden/Y.Neukian); Fire Prevention Engineering Section-(J.Halpert); Traffic & Transportation Section (P.Casanova/Mark Bueno-Traffic Engineer Assoc.); General Manager for Glendale Water and Power (Mark Young); Glendale Water & Power--Water Section (G. Tom/S. Boghosian/R.Takidin/C.Babakhanlou/D.Scorza); Glendale Water & Power--Electric Section (B. B.Ortiz/E.Olsen/ M.Navareete/M.Kouassi); Parks, Recreation and Community Services Dept. (T. Aleksanian); Neighborhood Services Division (R.Sada/J.Jouharian/); Integrated Waste Management Admin. (D. Hartwell); Maintenance Services Section Admin. (D. Hardgrove); Street and Field Services Admin.; Engineering and Environmental Management (C.Chew/R. Villaluna);and case planner (Cassandra Pruett).